

# VERDEX

EQUIPPING WORKPLACES



***Edition 25***

**1800 750 500**  
**verdex.com.au**  
**sales@verdex.com.au**



## EQUIPPING AUSTRALIAN WORKPLACES

Since 1985, Verdex (formerly MHA) has been dedicated to supplying Australian workplaces with the safest & highest quality workplace, safety & materials handling equipment.

We are family owned & operated company based in Australia with warehouse locations in Brisbane, Sydney and Melbourne. We are committed to creating better, safer & more productive workplaces by providing quality solutions Australia wide.



## THE VERDEX DIFFERENCE



Comprehensive Range



Fast Delivery Australia Wide



Quality Beyond Compare



100% Australian Owned



Australian Standards Compliant



Price Match Guarantee

With a catalogue with thousands of items, we can equip your workplace with our comprehensive range. Our products are extensively tested & comply to Australian Standards with certification available. You can trust that when you make a purchase with us, you are investing in equipment that's tried and proven.





## PRICE MATCH GUARANTEE

We believe in equipping workplaces with the best valued products. With our price match guarantee for all products, you can rest knowing you'll be receiving the best deal with Verdex.



## OUR TEAM, DEDICATED TO YOU

At Verdex we value & appreciate our customers, which is why our local customer service team is *dedicated to creating exceptional experiences*. You can trust that our team will be devoted to exceeding your expectations.



## ORDER ONLINE: [www.verdex.com.au](http://www.verdex.com.au)

- Account Portal
- Verdex Blogs
- Helpful Articles
- Buying Guides
- Product Specifications
- Various Payment Options
- Catalogue Downloads
- Free Giveaways



# NEW PRODUCTS

At Verdex we are committed to providing businesses with the safest & most efficient materials handling & workplace equipment. We strive to enhance & improve our customer's experience which is why our team are dedicated to expanding our supply scope. Check out some of our new products which have been recently added to our range.

## Enhancing Workspaces & Operations





## Heavy Duty Construction Equipment



See page 168



See page 170



See page 173

*Need Something  
Custom?*

**VERDEX HAS A TEAM OF IN-HOUSE DESIGNERS  
& ENGINEERS WHO CAN DESIGN THE PERFECT  
SOLUTION FOR YOUR REQUIREMENTS**

*Get in touch for further details*

Get in touch with the team today: 1800 750 500 | [sales@verdex.com.au](mailto:sales@verdex.com.au)

## Efficient Waste Handling Solutions



See page 258



See page 256



See page 256



See page 254



See page 263



See page 262

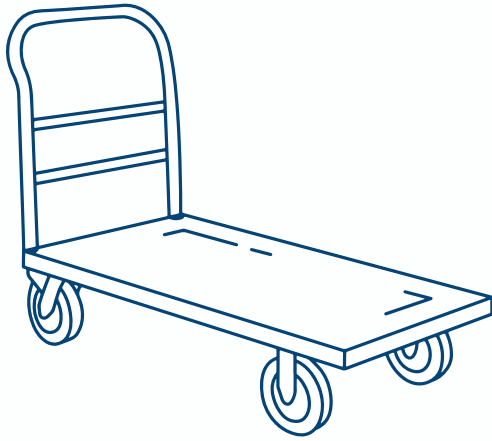

**Trolleys & Hand Trucks**

**Page 8-89**

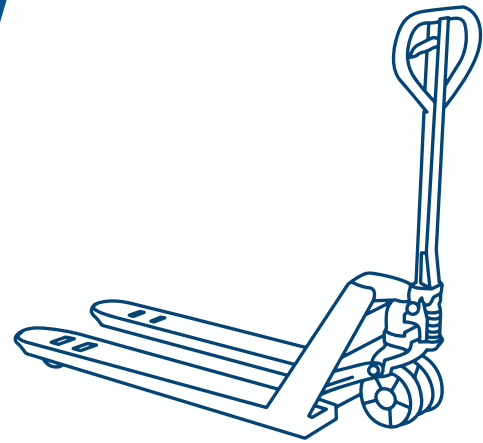

**Lifting & Handling Equipment**

**Page 174-217**

**Conveyor Solutions**

**Page 232-235**

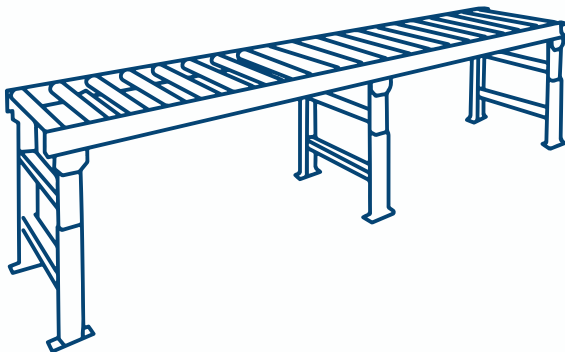

**Drum Handling Equipment**

**Page 218-231**

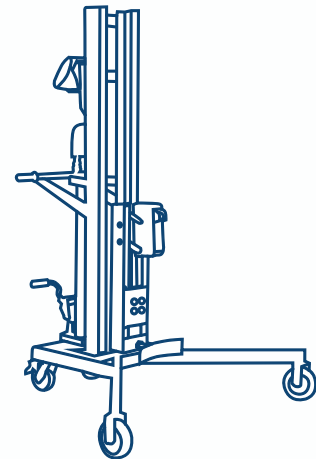

**Dangerous Goods Storage & Spillage Solutions**

**Page 266-283**

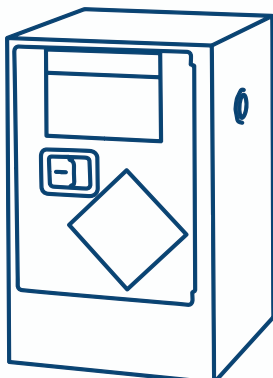

**Access Equipment**

**Page 158-165**

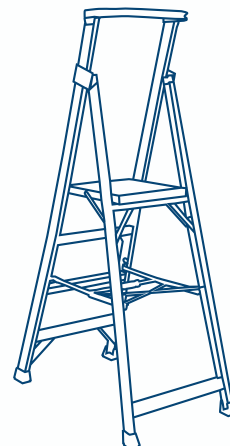



**Cleaning & Site Supplies**

**Page 236-243**

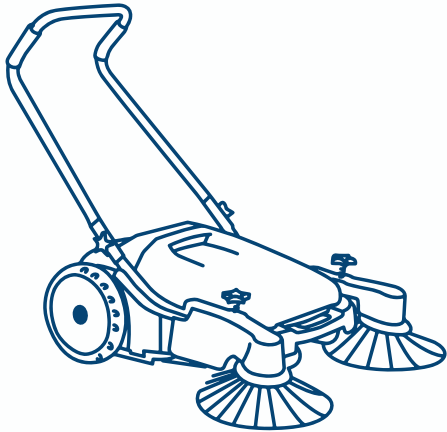

**Waste Handling & Bins**

**Page 244-265**

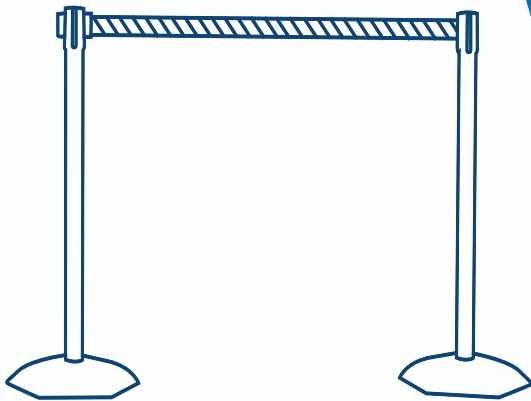
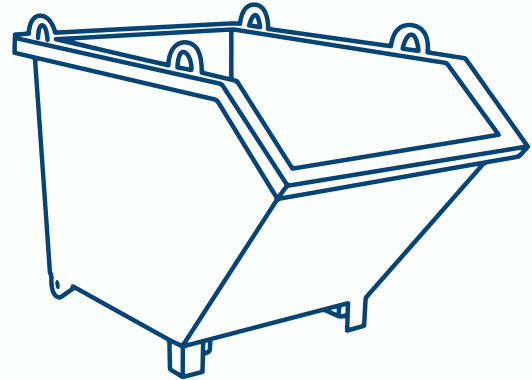

**Safety Barriers, PPE & Signage**

**Page 284-305**

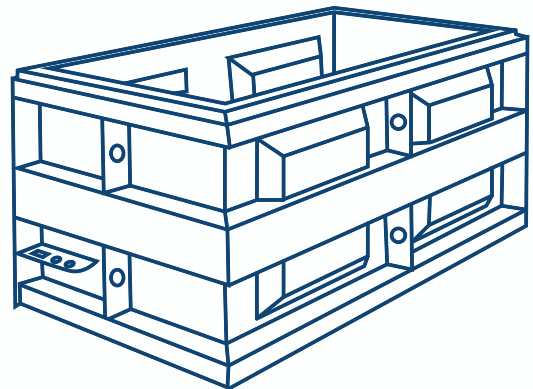

**Construction Equipment**

**Page 166-173**

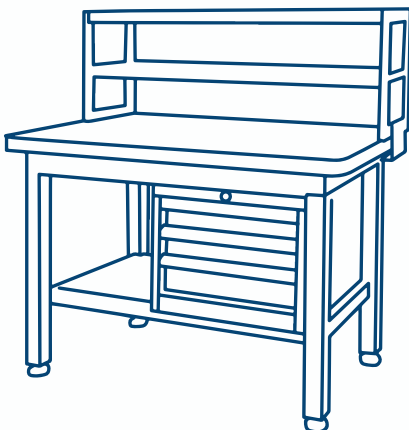

**Workplace Equipment**

**Page 90-113**

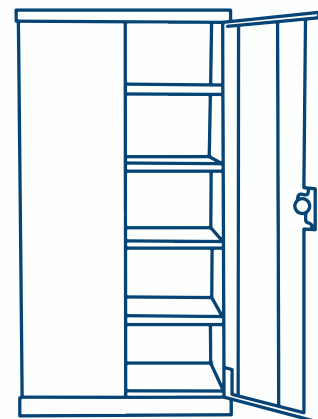

**Shelving & Storage Equipment**

**Page 114-154**

## Multi-Purpose Platform Trolleys (Folding Handle)

- Powder coated steel construction with vinyl decks
- Surround bumper on perimeter of trolley
- Rubber castors - 2 x fixed, 2 x swivel



Code	Load Capacity (kg)	Castors (mm)	Handle Height (mm)	Platform Size (mm)	Platform Height (mm)	Unit Weight (kg)
V1000	150	100	860	740x480	150	12
V1001	250	125	860	920x610	180	18

## Multi-Purpose Platform Trolleys (Fixed Handle)

- Powder coated steel construction with vinyl decks
- Surround bumper on perimeter of trolley
- Rubber castors - 2 x fixed, 2 x swivel



Code	Details	Load Capacity (kg)	Castors (mm)	Handle Height (mm)	Platform Size (mm)	Platform Height (mm)	Unit Weight (kg)
V1012	1 Handle	300	160	860	1150x750	240	35
V1013	2 Handle	300	160	860	1150x750	240	40





## Prestige Platform Trolleys

- Powder coated steel construction with vinyl decks
- Surround bumper on perimeter of trolley
- V1002 has a folding handle for compact storage when not in use
- Polyurethane castors - 2 x fixed, 2 x swivel
- Platform Height: 190mm



Code	Details	Load Capacity (kg)	Castors (mm)	Platform Size (mm)	Overall Size LxWxH (mm)	Unit Weight (kg)
V1002	1 Folding Handle	370	125	880x580	915x615x865	17
V1010	1 Fixed Handle	370	125	880x580	945x615x870	16
V1011	2 Fixed Handle	370	125	880x580	965x615x870	20
V1005	Brake Kit to suit V1002, V1010 and V1011					

## Extra Large Prestige Platform Trolley

- Powder coated steel construction with vinyl decks
- Surround bumper on perimeter of trolley
- Polyurethane castors - 2 x fixed, 2 x swivel 200mm
- Optional pneumatic wheel kit - includes 2 x fixed wheels and 2 x swivel wheels with brakes



Code	Details	Load Capacity (kg)	Overall Size LxWxH (mm)	Platform Size (mm)	Platform Height (mm)	Unit Weight (kg)
V1015	XL Platform Trolley	650	1180x765x1035	1125x720	245	40
V1016	Optional Extra Handle					

## Heavy Duty Steel Platform Trolleys

- Heavy duty steel platform trolleys are ideal for general warehouse use
- Available in 3 sizes
- Welded steel construction
- Durable baked enamel paint finish
- Rubber castors - 2 x fixed, 2 x swivel with brakes



Code	Load Capacity (kg)	Castors (mm)	Overall Length (mm)	Handle Height (mm)	Platform Size (mm)	Platform Height (mm)	Unit Weight (kg)
V1040	540	200	1020	970	920x610	290	32
V1041	540	200	1320	970	1220x610	290	36
V1043	540	200	1620	970	1520x760	290	49

## Heavy Duty Aluminium Platform Trolleys

Strong and lightweight aluminium platform trolleys which are great for general transportation of goods around warehouses, shopping centres and courier goods delivery.

- Lightweight and corrosion resistant
- Highly manoeuvrable & heavy duty construction
- Checker plate deck
- Removable handles (comes standard with 1 Handle)
- 3 standard sizes available
- Polyurethane castors - 2 x fixed, 2 x swivel with brakes
- Optional flat free wheel kit available - 2 x fixed wheels and 2 x swivel wheels with brakes

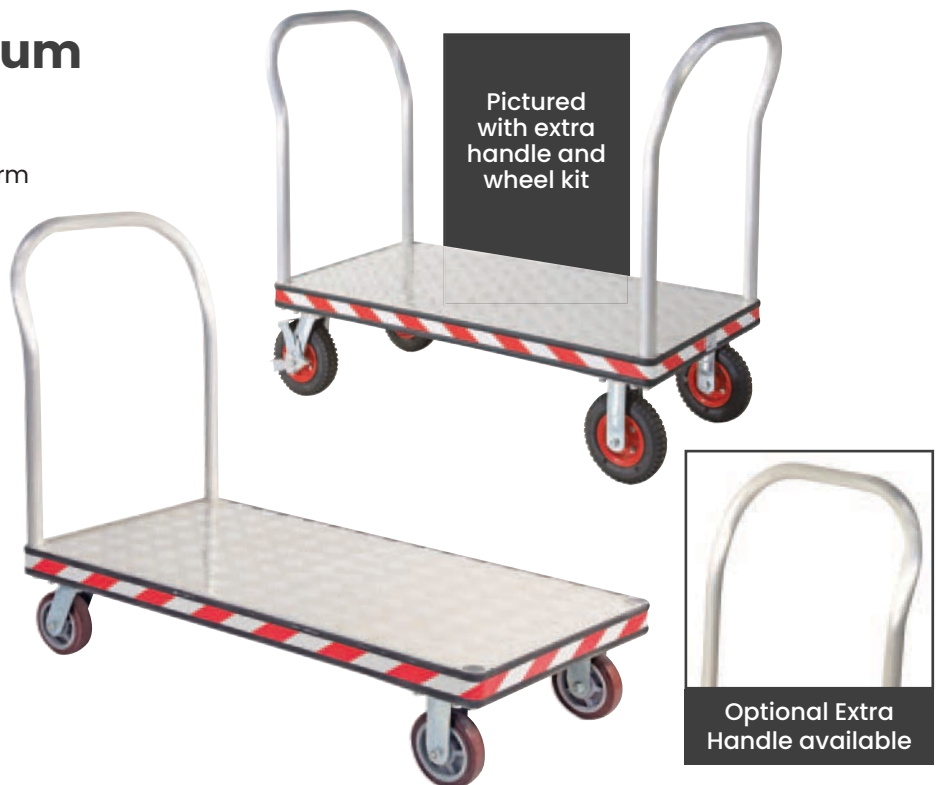

Code	Details	Load Capacity (kg)	Castors (mm)	Handle Height (mm)	Platform Size (mm)	Platform Height (mm)	Unit Weight (kg)
V1050	Platform Trolley	500	125	1010	930x620	260	22
V1051	Platform Trolley	500	125	1010	1230x620	260	25
V1052	Platform Trolley	500	125	1010	1530x770	260	30
V1053	Optional 2nd Handle to suit V1050 & V1051						
V1054	Optional 2nd Handle to suit V1052						
V1055	Flat Free Wheel Kit						3.5





## Foldable Plastic Deck Trolley

- Folding aluminium and plastic trolley ideal for retail areas, office areas, delivery vans and transporting lightweight goods
- Extremely lightweight and compact trolley which folds flat
- The trolley also fits the V-Cart Folding Basket (see page 16)
- Hard clip-on lid available for the V-Cart Basket
- 3 Handle heights: 725mm, 825mm and 925mm
- Rubber castors - 2 x fixed, 2 x swivel
- Platform Height: 180mm
- Platform Size: 670x405mm



Extra Basket (V1805)



Hard Lid to suit Basket (V1806)

Code	Details	Load Capacity (kg)	Castors (mm)	Folded Size LxWxH (mm)	Open Size LxWxH (mm)	Unit Weight (kg)
V1197	Foldable Plastic Deck Trolley	137	100	670x405x80	670x405x925	6
V1805	V-Cart Extra Basket					
V1806	Lid to suit V-Cart Basket					

## Nestable Stock Trolley

- The Nestable Stock Trolley is ideal for transporting heavy boxes and other product long and awkward items, due to its open platform design and quality construction.
- Platform folds up for nesting
- Electro galvanised construction and powder coated handles
- Rubber castors - 4 x swivel



Code	Load Capacity (kg)	Castors (mm)	Platform Size (mm)	Overall Size LxWxH (mm)	Unit Weight (kg)
V1260	200	125	850x600	1170x700x980	22

## Heavy Duty Single Handle Platform Trolley

- Bolt together steel construction (supplied flatpack)
- Powder coated blue
- Rubber castors - 2 x fixed, 2 x swivel with brakes
- Optional flat free wheel kit available - 2 x fixed wheels and 2 x swivel wheels with brakes
- Load Capacity (with flat free wheel kit): 550kg
- Load Capacity with pneumatic wheels: 200kg
- Handle Height: 1000mm



Code	Castors (mm)	Platform Size (mm)	Platform Height (mm)	Overall Size LxWxH (mm)	Unit Weight (kg)
VI850	160	1100x600	230	1200x610x990	48



## Heavy Duty Double Handle Platform Trolley

- Bolt together steel construction (supplied flatpack)
- Powder coated blue
- Rubber castors - 2 x fixed, 2 x swivel with brakes
- Optional flat free wheel kit available - 2 x fixed wheels and 2 x swivel wheels with brakes
- Load Capacity with standard wheels: 550kg
- Load Capacity with pneumatic wheels: 200kg
- Handle Height: 1000mm
- Platform Height: 230mm

Code	Castors (mm)	Platform Size (mm)	Platform Height (mm)	Overall Size LxWxH (mm)	Unit Weight (kg)
VI860	160	1100x600	230	1305x610x990	53

## Heavy Duty 2 Tier Platform Trolley

- Bolt together steel construction (supplied flatpack)
- Powder coated blue
- Top platform and extra shelves can be used as flat shelf or turned upside down to be used as a tray
- Additional shelf available to make it multi-tier
- Rubber castors - 2 x fixed, 2 x swivel with brakes
- Optional flat free wheel kit available - 2 x fixed wheels and 2 x swivel wheels with brakes
- Handle Height: 1000mm
- Load Capacity with standard wheels: 550kg
- Load Capacity with pneumatic wheels: 200kg



Code	Castors (mm)	Platform Size (mm)	Platform Heights (mm)	Overall Size LxWxH (mm)	Unit Weight (kg)
VI862	160	1100x600	230mm + 720mm	1305x610x990	66



# Accessories to suit Platform Trolleys



V1840 - Drink Holder



V1841 - Clipboard Holder



V1842 - Laptop & RF Scanner Holder



V1843 - Mesh Basket Accessory Tray



V1844 - Accessory Shelf

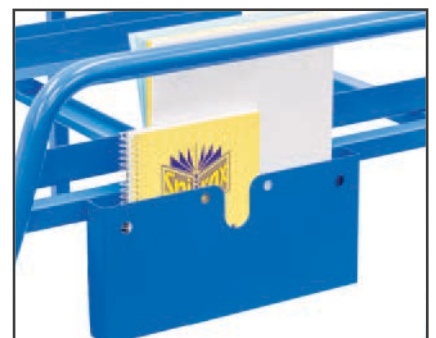

V1848 - A4 Pocket



V1849 - Scanner Holder



V1852 - Extra Shelf



V1853 - Centre Wheel Kit



V1845 - Flat Free Wheel Kit

See video of the Verdex Heavy Duty Platform Trolleys



Watch a video of this in operation on our website here, [www.verdex.com.au/V1850](http://www.verdex.com.au/V1850)



Code	Details
V1840	Drink Holder
V1841	Clipboard Holder
V1842	Laptop & RF Scanner Holder
V1843	Mesh Basket Accessory Tray
V1844	Accessory Shelf
V1848	A4 Pocket
V1849	Scanner Holder
V1852	Extra Shelf (Only Suits V1862)
V1853	Centre Wheel Kit with Swivel Brake
V1845	Flat Free Wheel Kit (includes 2 swivel wheels with brakes and 2 fixed wheels)



## Powered Platform Trolley

These powered heavy duty platform trolleys provide a strong 400kg capacity platform to move heavy items around your workplace.

- Comes with a removable cage (as pictured) to avoid items falling off while moving.
- Platform has an anti-slip grip so that items don't slide off easily in transit.
- Rubber bumper edge
- Emergency stop button
- Comes with forward and reverse drive options
- Variable speed controller
- Powered by 2 x 12V / 33Ah batteries
- 2 x swivel castors
- 2 x pneumatic drive wheels
- Clearance From Battery Box to Ground: 65mm
- Electro magnetic brake
- Cage Height: 930mm
- Moving Speed: 5-8km/h



Code	Load Capacity (kg)	Front Wheels (mm)	Rear Castors (mm)	Handle Height (mm)	Platform Size (mm)	Platform Height (mm)	Overall Size LxWxH (mm)	Unit Weight (kg)
VI065	400	260	150	1080	1290x640	320	1420x630x1090	110



See page 180



See page 180



See page 181



# Powered Dump Truck

- Great for dirt, bark and rubbish removal in outdoor areas
- Emergency stop button
- Forward and reverse drive
- Variable speed controller
- Powered by 3 x 12V / 55Ah batteries
- Pneumatic wheels
- Moving Speed: 5-8km/h
- Lift Time: 15 secs
- Lift Angle: 45 degrees
- Electro magnetic brake



Watch a video of this in operation on our website here, [www.verdex.com.au/V1067](http://www.verdex.com.au/V1067)



Code	Load Capacity (kg)	Wheels (mm)	Handle Height from Ground (mm)	Tray Height from Ground (mm)	Tray Size LxWxH (mm)	Overall Size LxWxH (mm)	Unit Weight (kg)
V1067	800	325	1000	740	1510x800x310	2250x810x1070	250

# Large Powered Platform Trolley

- Great for both indoor and outdoor use with high load capacity
- Platform has an anti-slip grip so that items don't slide off easily in transit
- Rubber bumper edge
- Supplied with removable cage
- Emergency stop button
- Forward and reverse drive
- Variable speed controller
- Powered by 3 x 12V / 55Ah batteries
- Pneumatic wheels
- Clearance From Battery Box to Ground: 75mm
- Moving Speed: 5-8km/h
- Electro magnetic brake



Supplied standard with removable cage to prevent items falling off during transit



Code	Load Capacity (kg)	Wheels (mm)	Handle Height (mm)	Platform Size (mm)	Platform Height (mm)	Overall Size With Cage LxWxH (mm)	Unit Weight (kg)
V1066	800	310	950	1400x900	385	2070x900x980	170





# V-Cart Folding Plastic and Aluminium Trolley

- The V-Cart is a collapsible trolley that can be used for hundreds of applications.
- It is ideal for use in the workplace, schools, home, office, hospitals, courier services, shopping malls, nursing homes as much more!
- It can be completely collapsed by the push of a button on the handle. The wheels are able to be removed by the push of a button and stored underneath for compact transport and storage.
- The V-Cart is supplied with one collapsible basket which will lock into place on either the top or bottom platform.
- The top platform can be folded back to allow larger items to be transported if required.
- Features support bars that give added stability to the top platform
- Extra baskets are available for use on both platforms or up to 4 baskets can be stacked on the bottom platform.
- A robust foot pedal brake allows the V-Cart to be locked in position whilst loading or unloading.
- The injection moulded plastic and aluminium design means that whilst the V-Cart is lightweight it is still very robust and has a great carrying capacity.
- The basket fits foolscap suspension files, which is great for transporting documents throughout the office.
- The V-Cart can also be used with our standard No.7, No.10.No.15 tubs



## Specifications

- Total Trolley Capacity: 90kg
- Top Shelf Capacity: 40kg
- Bottom Shelf Capacity: 50kg
- Trolley Weight: 10kg
- Basket Weight: 1.8kg
- Handle Height: 1050mm

## Dimensions

- Overall Length Assembled: 1000mm
- Overall Width Assembled: 600mm
- Overall Height Assembled: 1070mm
- Overall Length Folded: 740mm
- Overall Width Folded: 540mm
- Overall Height Folded: 105mm

# V-CART»»



View video of this in operation here  
[www.verdex.com.au/vcart](http://www.verdex.com.au/vcart)



Extra Basket (V1805)



Hard Lid to suit Basket (V1806)



Rain Cover (V1810)



Tool Bin (V1815)

Code	Details
V1800	V-Cart Folding Plastic & Aluminium Trolley (Includes 1 Folding Basket)
V1805	V-Cart Extra Basket
V1806	Lid to suit V-Cart Basket
V1810	V-Cart Vinyl Cover
V1815	V-Cart Tool Bin





# Customise your V-Cart with accessories

*V-Cart pictured with additional basket and tool bin*



## Multi-Purpose 2 Tier Trolleys

- General purpose industrial quality 2 tier trolleys for goods movement
- Powder coated steel construction with vinyl decks
- Surround bumper on perimeter of trolley
- V1020 - Rubber castors - 2 x fixed, 2 x swivel
- V1021 - Polyurethane castors - 2 x fixed, 2 x swivel



Brake Kit (V1005)



V1020



V1021

Code	Details	Load Capacity (kg)	Castors (mm)	Handle Height (mm)	Shelf Size (mm)	Shelf Heights (mm)	Unit Weight (kg)
V1020	2 Tier Trolley	120	100	860	750x490	140 + 660	20
V1021	2 Tier Trolley	370	125	930	965x615	180 + 780	27
V1005	Brake Kit to suit V1021						

## Multi-Purpose 3 Tier Trolleys

- General purpose industrial quality trolleys for transporting goods safely in the workplace
- Powder coated steel construction with vinyl decks
- Surround bumper on perimeter of trolley
- V1025 - Rubber castors - 2 x fixed, 2 x swivel
- V1026 - Polyurethane castors - 2 x fixed, 2 x swivel

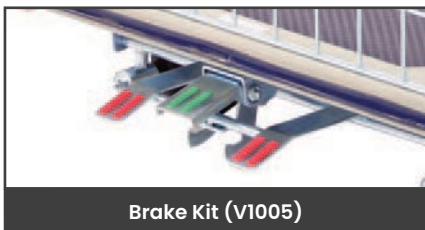

Brake Kit (V1005)



V1026



V1025

Code	Details	Load Capacity (kg)	Castors (mm)	Handle Height (mm)	Shelf Size (mm)	Shelf Heights (mm)	Unit Weight (kg)
V1025	3 Tier Trolley	120	100	860	740x480	140 + 410 + 660	26
V1026	3 Tier Trolley	370	125	990	920x620	180 + 480 + 780	36
V1005	Brake Kit to suit V1026						



## 3 Tier Multi Shelf Trolley

- 3 Tiered Multi Shelf Trolley is ideal for order picking and transporting goods in the workplace
- Suitable for use in retail and industrial applications
- The shelves can be used as a flat platform or turned upside down and used as a tray
- Powder coated finish
- Overall Size (LxWxH): 1080x480x940mm
- Rubber castors - 2 x swivel, 2 x swivel with brakes



Code	Load Capacity (kg)	Castors (mm)	Shelf Size (mm)	Distance Between Shelves (mm)	Height to Top Shelf (mm)	Unit Weight (kg)
V1661	250	125	900x440	250	760	30

## Tall Multi Shelf Trolley

- The multi tier shelf trolley is ideal for order picking & transporting goods in the workplace
- Suitable for use in retail & industrial applications
- Supplied standard with 3 shelves (extra shelves available)
- The shelves can be used as a flat platform or turned upside down and used as a tray
- Powder coated finish
- Available in Blue or White
- Overall Size (LxWxH): 980x585x1445mm
- Rubber castors - 2 x swivel, 2 x swivel with brakes



Code	Details	Load Capacity (kg)	Castors (mm)	Shelf Size (mm)	Height to Top Shelf (mm)	Unit Weight (kg)
V1664	White Trolley	250	125	900x540	1340	39
V1665	Extra Shelf to Suit V1664					6



## 2 Tier Steel Trolley

- Simple bolt together construction
- Powder coated blue finish
- Reversible top shelf which gives a tray option
- Rubber castors - 125mm (2 x fixed, 2 x swivel with brakes)
- Many accessories available to suit - see page 25
- Distance between shelves: 665mm
- Load Capacity with standard castors: 300kg
- Load Capacity with pneumatic castors: 200kg

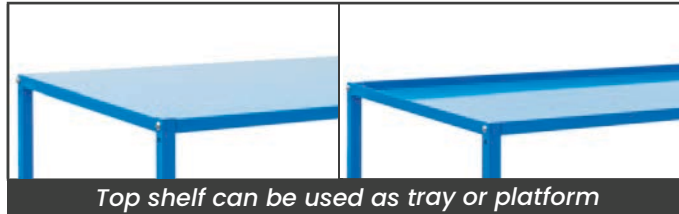

Code	Handle Height (mm)	Overall Size LxWxH (mm)	Internal Tray Size LxWxH (mm)	Shelf Size (mm)	Shelf Heights (mm)	Unit Weight (kg)
VI880	1050	1095x660x1050	905x600	960x655	184 + 875	32.5

## 3 Tier Steel Trolley

- Simple bolt together construction
- Powder coated blue finish
- Middle shelf is removable if not required
- Reversible top and middle shelf which gives a tray option
- Rubber castors - 125mm (2 x fixed, 2 x swivel with brakes)
- Many accessories available to suit - see page 25
- Distance between shelves: 313mm
- Load Capacity with standard castors: 300kg
- Load Capacity with pneumatic castors: 200kg

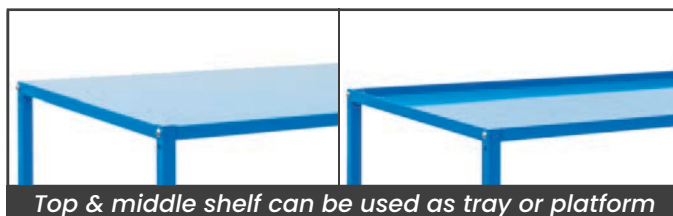

Code	Handle Height (mm)	Internal Tray Size LxWxH (mm)	Overall Size LxWxH (mm)	Shelf Size (mm)	Shelf Heights (mm)	Unit Weight (kg)
VI881	1050	905x600	1095x660x1050	960x655	184 + 530 + 875	41.5



## 2 Tier Steel Tub Trolley

- Simple bolt together construction
- Powder coated blue finish
- Supplied standard with no tubs
- Fits a variety of tubs - see online for more details
- Bin colours: Black, Red, Blue, Green, Yellow & White
- Rubber castors - 2 x fixed, 2 x swivel with brakes
- Many accessories available to suit - see page 25
- Distance between shelves: 665mm
- V1882K pictured - which comes with 4x No. 4D Recycled Plastic Black Bins
- Load Capacity with standard castors: 300kg
- Load Capacity with pneumatic castors: 200kg



Accessories available to suit - See page 25

Code	Details	Castors (mm)	Handle Height (mm)	Overall Size LxWxH (mm)	Shelf Size (mm)	Base Height (mm)	Unit Weight (kg)
V1882	2 Tier Tub Trolley	125	1050	1095x660x1050	960x655	184	28
V1882K	2 Tier Tub Trolley - Supplied with 4 x No 4D Black Tubs						31

## 3 Tier Steel Tub Trolley

- Simple bolt together construction
- Powder coated blue finish
- Supplied standard with no tubs
- Fits a variety of tubs - see online for more details
- Bin colours: Black, Red, Blue, Green, Yellow & White
- Tubs sit inside rails
- Rubber castors - 2 x fixed, 2 x swivel with brakes
- Many accessories available to suit - see page 25
- Distance between shelves with no tubs: 665mm
- V1883K pictured - which comes with 8x No. 4D Recycled Plastic Black Bins
- Load Capacity with standard castors: 300kg
- Load Capacity with pneumatic castors: 200kg



Accessories available to suit - See page 25

Code	Details	Castors (mm)	Handle Height (mm)	Overall Size LxWxH (mm)	Shelf Size (mm)	Base Height (mm)	Unit Weight (kg)
V1883	3 Tier Tub Trolley	125	1050	1095x660x1050	960x655	184	32
V1883K	3 Tier Tub Trolley - Supplied with 8 x No 4D Black Tubs						39

### 3 Tier Multi-Tub Trolley

- Simple bolt together construction
- Powder coated blue finish
- Supplied standard with no tubs
- Fits a variety of tubs - see online for more details
- Bin colours: Black, Red, Blue, Green, Yellow & White
- Tubs sit in channels as pictured
- Rubber castors - 2 x fixed, 2 x swivel with brakes
- Many accessories available to suit - see page 25
- V1884K pictured - which comes with 4x No. 10 Recycled Plastic Black Bins
- Load Capacity with standard: 300kg
- Load Capacity with pneumatic castors: 200kg

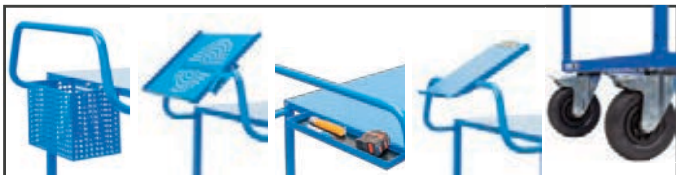

Accessories available to suit - See page 25

Code	Details	Castors (mm)	Handle Height (mm)	Overall Size LxWxH (mm)	Shelf Size (mm)	Base Height (mm)	Unit Weight (kg)
V1884	3 Tier Multi-Tub Trolley	125	1050	1095x660x1050	960x655	184	38
V1884K	3 Tier Multi-Tub Trolley - Supplied with 4 x No 10 Black Tubs						

### 2 Tier Single Basket Trolley

- Simple bolt together construction
- Powder coated blue finish
- Mesh basket as top tray with 25mm punch holes
- Rubber castors - 2 x fixed, 2 x swivel with brakes
- Many accessories available to suit - see page 25
- Clearance from shelf to underside of basket: 460mm
- Basket Size (LxWxH): 905x600x225mm
- Load Capacity with standard castors: 300kg
- Load Capacity with pneumatic castors: 200kg



Accessories available to suit - See page 25

Code	Castors (mm)	Handle Height (mm)	Overall Size LxWxH (mm)	Shelf Size (mm)	Base Height (mm)	Unit Weight (kg)
V1885	125	1050	1095x660x1050	960x655	184	35.5





## 2 Tier Double Basket Trolley

- Simple bolt together construction
- Powder coated blue finish
- Mesh basket as top tray with 25mm punch holes
- Rubber castors - 2 x fixed, 2 x swivel with brakes
- Many accessories available to suit - see page 25
- Bottom mesh basket can be removed if not required
- Distance between baskets: 230mm
- Basket Size (LxWxH): 905x600x225mm
- Load Capacity with standard castors: 300kg
- Load Capacity with pneumatic castors: 200kg

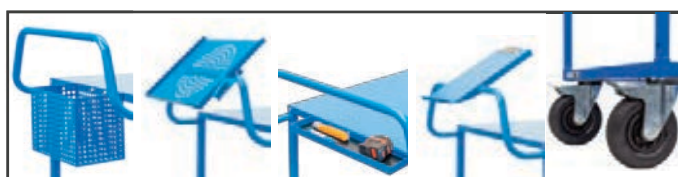

Accessories available to suit - See page 25

Code	Castors (mm)	Handle Height (mm)	Overall Size LxWxH (mm)	Shelf Size (mm)	Base Height (mm)	Unit Weight (kg)
V1886	125	1050	1095x660x1050	960x655	184	45

## 2 Tier Deep Basket Trolley

- Simple bolt together construction
- Powder coated blue finish
- Mesh basket as top tray with 25mm punch holes
- Rubber castors - 2 x fixed, 2 x swivel with brakes
- Many accessories available to suit - see page 25
- Load Capacity with standard castors: 300kg
- Load Capacity with pneumatic castors: 200kg
- Clearance from shelf to underside of basket: 313mm
- Upper Level Height: 530mm
- Distance between Shelves: 313mm

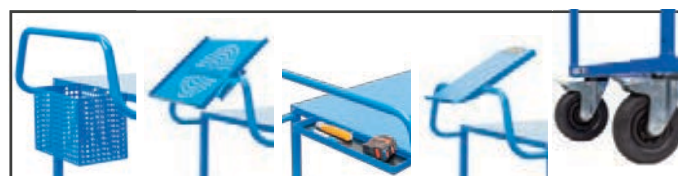

Accessories available to suit - See page 25

Code	Castors (mm)	Handle Height (mm)	Basket Size LxWxH (mm)	Overall Size LxWxH (mm)	Shelf Size (mm)	Base Height (mm)	Unit Weight (kg)
V1893	125	1050	905x600x375	1095x660x1050	960x655	184	44

## 2 Tier Rubber Top Trolley

- Simple bolt together construction
- Powder coated blue finish
- Top shelf has a rubber mat which prevents items from sliding around in transit
- Supplied standard with no tubs
- Fits a variety of tubs - see online for more details
- Rubber castors - 2 x fixed, 2 x swivel with brakes
- Load Capacity with standard wheels: 300kg
- Load Capacity with pneumatic wheels: 200kg
- Many accessories available to suit - see page 25
- V1887K Pictured - which comes with 2x No. 10 Recycled Plastic Black Bins

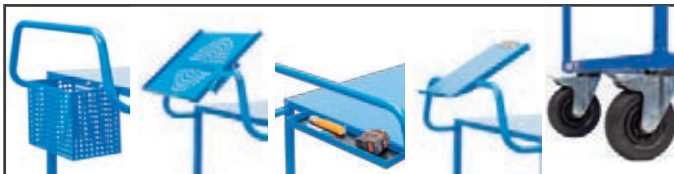

Accessories available to suit - See page 25

Code	Details	Castors (mm)	Platform Heights (mm)	Handle Height (mm)	Overall Size LxWxH (mm)	Shelf Size (mm)	Unit Weight (kg)
V1887	2 Tier Rubber Top Trolley	125	184 + 875	1050	1095x660x1050	960x655	33.5
V1887K	2 Tier Rubber Top Trolley - Supplied with 2 x No 10 Black Tubs						46

## Steel Trolleys featuring Accessories



**V1887** - 2 Tier Rubber Top Trolley with V1843 and 2 x No. 10 Bins



**V1884** - 3 Tier Multi-Tub Trolley with V-Cart Baskets



**V1883** - 3 Tier Steel Tub Trolley with 4 x No.10 Stack & Nest Crates



**V1880** - 2 Tier Trolley with V1841





## Accessories to suit Steel Trolleys

- Range of accessories to suit trolleys on pages 20-24



V1840 - Drink Holder

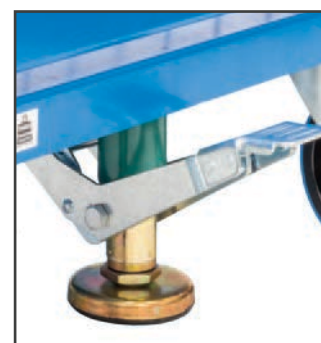

V1841 - Clipboard Holder

V1842 - Laptop  
& RF Scanner HolderV1843 - Mesh Basket  
Accessory TrayV1844 -  
Accessory ShelfV1845 - Flat Free  
Wheel KitV1846 - Floor  
Lock BrakeV1849 -  
Scanner Holder

V1848 - A4 Pocket

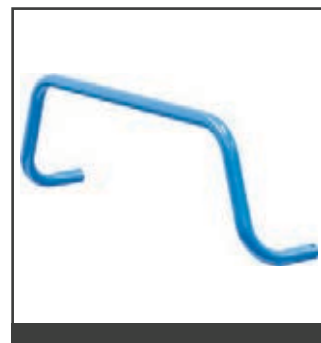
V1865 - Ladder &  
Handle Kit

V1868 - Extra Handle

Code	Details	Overall Size LxWxH (mm)	Unit Weight (kg)
V1840	Drink Holder	120x120x80	0.54
V1841	Clipboard Holder	340x230x44	1.4
V1842	Laptop & RF Scanner Holder	422x300	2.4
V1843	Mesh Basket Accessory Tray	272x145x187	1.1
V1844	Accessory Shelf	400x100x25	1
V1848	A4 Pocket	310x33x145	1
V1849	Scanner Holder	110x68x145	0.68
V1845	Flat Free Wheel Kit (2 x swivel with brakes & 2 x fixed)	-	-
V1846	Floor Lock Brake	-	-
V1865	Ladder & Handle Kit	670x570x1535	15
V1868	Extra Handle	655x134x225	1



## 4 Tier Steel Trolley

- These steel trolleys are versatile & have a simple bolt together construction.
- They feature reversible shelves which can also serve as a tray option & are suitable for a range of industrial applications
- Simple bolt together construction
- Load Capacity with pneumatic castors: 200kg
- Rubber castors: 125mm (2 x fixed & 2 x swivel with brakes)
- Load Capacity with standard castors: 300kg
- Load Capacity with pneumatic castors: 200kg
- Many accessories available to suit - see page 25



Code	Handle Height (mm)	Overall Size LxWxH (mm)	Overall Shelf Size (mm)	Internal Shelf Size (mm)	Base Height (mm)	Unit Weight (kg)
V1894	1050	1095x660x1221	960x655	905x600	184	51.5

## 5 Tier Steel Trolley

- These steel trolleys are versatile & have a simple bolt together construction.
- Load Capacity with pneumatic castors: 200kg
- Handle Height: 1050mm
- 125mm rubber castors: 2 x fixed & 2 x swivel with brakes
- Load Capacity with standard castors: 300kg
- Load Capacity with pneumatic castors: 200kg
- Upper Shelf Height: 1573mm
- Many accessories available to suit - see page 25



Code	Handle Height (mm)	Overall Size LxWxH (mm)	Overall Shelf Size (mm)	Internal Shelf Size (mm)	Base Height (mm)	Unit Weight (kg)
V1895	1050	1095x660x1573	960x655	905x600	184	62



## 2 Tier Trolley with Bottom Basket

- These steel trolleys are versatile & have a simple bolt together construction.
- They feature reversible shelves which can also serve as a tray option & are suitable for a range of industrial applications
- Simple bolt together construction
- 25mm rubber castors: 2 x fixed & 2 x swivel with brakes
- Internal Tray Size: 905x600
- Distance between shelves: 337.50mm
- Load Capacity with standard castors: 300kg
- Load Capacity with pneumatic castors: 200kg
- Many accessories available to suit - see page 25



Code	Castors (mm)	Handle Height (mm)	Upper Shelf Height (mm)	Overall Size LxWxH (mm)	Basket Size LxWxH (mm)	Base Height (mm)	Unit Weight (kg)
VI896	125	1050	1221	1095x660x1221	905x600x375	184	51

## YOU MAY ALSO LIKE OUR STACK & NEST CRATES



See page 131



# Auto Levelling Trolley

- The Auto Levelling Trolley is designed to dramatically reduce back injuries and strain as the load automatically increases in height as items are lifted off and lowers as items are loaded.
- The top shelf is self levelling at 0-250kg
- At 200kg the top shelf will be at the lowest position which is 290mm above the bottom shelf allowing for empty crates to be stored underneath
- Bottom Platform Height: 200mm
- Top Platform Height: 890mm (highest position)
- Top Platform Height: 485mm (lowest position)
- Type of castors - 4 swivel 2 with brake
- 4 x elastic rubber castor swivel castors diameter 125mm and 2 fixed centre wheels which allow forturning within its own length.
- Spring operated press foot floor brake



4 x swivel castors, 2 with brakes



At 200kg the top shelf will be at the lowest position which is 290mm above the bottom shelf, allowing for empty crates to be stored underneath

Highest Position: 890mm  
 Lowest Position: 485mm  
 Bottom Platform: 200mm



Watch a video of this in operation on our website here, [www.verdex.com.au/LT2047](http://www.verdex.com.au/LT2047)



Code	Load Capacity (kg)	Top Shelf Capacity (kg)	Castors (mm)	Handle Height (mm)	Internal Platform Size LxW (mm)	Overall Size LxWxH (mm)	Unit Weight (kg)
LT2047	400	200	125	995	1200x585	1525x675x1052	62







## 2 Tier Trolley (With Adjustable Shelves)

- This 2 tier trolley is ideal for stock picking in warehouses and retail applications.
- Optional ladder and clipboard.
- Ladder can be folded up for compact storage when not in use.
- Electro galvanised finish with laminate shelves
- Shelf Size: 1000x425mm
- Rubber castors - 2 x swivel, 2 x swivel with brakes



Ergonomic Handle



Optional Ladder



Optional Clipboard

Code	Details	Load Capacity (kg)	Castors (mm)	Overall Size LxWxH (mm)	Unit Weight (kg)
V1670	2 Tier Trolley (with adjustable shelves)	250	125	1195x470x1120	26
V1672	Optional Ladder with Handles	125	-	550x450x670	9
V1841Z	Optional Clipboard Unit				

## 3 Tier Trolley (With Adjustable Shelves)

- This 3 tier trolley is ideal for stock picking in warehouses and retail applications.
- Middle shelf is height adjustable
- Optional ladder can be folded up for compact storage when not in use.
- Electro galvanised finish with laminate shelves
- Shelf Size: 1000x425mm
- Rubber castors - 2 x swivel, 2 x swivel with brakes



Optional Clipboard Available



Optional Ladder Available

Code	Details	Load Capacity (kg)	Castors (mm)	Overall Size LxWxH (mm)	Unit Weight (kg)
V1671	3 Tier Trolley (with adjustable shelves)	250	125	1195x470x1120	30
V1672	Optional Ladder with Handles	125	-	550x450x670	9
V1841Z	Optional Clipboard Unit				

## Stainless Steel Instrument Trolleys

- High grade 304 grade stainless steel
- 2 trolleys available with 2 sides and rail on 3 sides
- Rubber castors - 2 x swivel, 2 x swivel with brakes
- Front castors have locks
- Smooth welding



Code	Details	Castors (mm)	Shelf Capacity (kg)	Overall Size WxDxH (mm)	Unit Weight (kg)
V1546	Instrument Trolley (No Rails)	95	80	500x500x900	10.5
V1547	Instrument Trolley (No Rails)	95	80	600x500x900	11
V1548	Instrument Trolley (No Rails)	95	80	800x500x900	14

## Stainless Steel Instrument Trolleys (With Rails)

- High grade 304 grade stainless steel
- 2 trolleys available with 2 sides and rail on 3 sides
- Rubber castors - 2 x swivel, 2 x swivel with brakes
- Rails on top and bottom shelf
- Front castors have locks
- Smooth welding

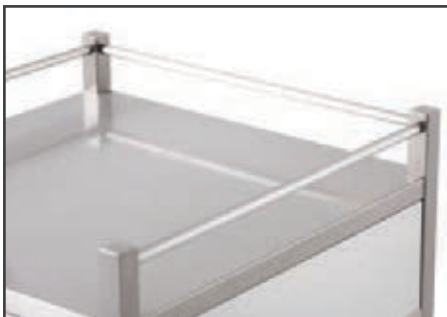

Rails on top platform to stop items falling off the back



Code	Details	Castors (mm)	Shelf Capacity (kg)	Overall Size WxDxH (mm)	Unit Weight (kg)
V1530	Single Instrument Trolley (With Rails)	95	80	500x500x900	11
V1535	Double Instrument Trolley (With Rails)	95	80	800x500x900	14



## Stainless Steel Trolleys (with Drawers)

- High grade 304 grade stainless steel
- 495mm deep drawers
- German made drawer runners which are soft closing
- Rails on top and bottom shelf
- Rubber castors - 2 x swivel, 2 x swivel with brakes
- Front Castors feature locks
- Smooth welding

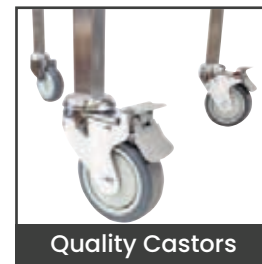

V1531



V1532



V1533



V1534

Code	Details	Castors (mm)	Drawer Capacity (kg)	Shelf Capacity (kg)	Overall Size WxDxH (mm)	Unit Weight (kg)
V1531	Single Instrument Trolley (1 Drawer)	95	25	80	500x500x900	17.5
V1532	Single Instrument Trolley (2 Drawer)	95	25	80	500x500x900	23
V1533	Single Instrument Trolley (3 Drawer)	95	25	80	500x500x900	29.5
V1534	Single Instrument Trolley (4 Drawer)	95	25	80	500x500x900	34

## Double Stainless Steel Instrument Trolleys (With Drawers)

- High grade 304 grade stainless steel
- 495mm deep drawers
- German made drawer runners which are soft closing
- Rails on top and bottom shelf
- Rubber castors - 2 x swivel, 2 x swivel with brakes
- Front Castors feature locks
- Smooth welding



V1536



V1537



V1538



V1539

Code	Details	Castors (mm)	Drawer Capacity (kg)	Shelf Capacity (kg)	Overall Size WxDxH (mm)	Unit Weight (kg)
V1536	Double Instrument Trolley (1 Drawer)	95	25	80	800x500x900	23
V1537	Double Instrument Trolley (2 Drawer)	95	25	80	800x500x900	32
V1538	Double Instrument Trolley (2 Drawer Side by Side)	95	25	80	800x500x900	26
V1539	Double Instrument Trolley (4 Drawer - 2 x Side by Side)	95	25	80	800x500x900	36



## Double Stainless Steel Instrument Trolleys (With Drawers)

- High grade 304 grade stainless steel
- 495mm deep drawers
- German made drawer runners which are soft closing
- Rails on top and bottom shelf
- Rubber castors - 2 x swivel, 2 x swivel with brakes
- Front Castors feature locks
- Smooth welding



Soft close drawers



V1540



V1541



V1542



V1543

Code	Details	Castors (mm)	Drawer Capacity (kg)	Shelf Capacity (kg)	Overall Size WxDxH (mm)	Unit Weight (kg)
V1540	Instrument Trolley (5 Drawer - 4x Half Side By Side, 1 Full)	95	25	80	800x500x970	44
V1541	Instrument Trolley (6 Drawer with 2 Shelves)	95	25	80	900x500x970	55
V1542	Instrument Trolley (6x Half Side By Side, 1 Full)	95	25	80	800x500x970	55.5
V1543	Instrument Trolley (4 Drawer)	95	25	80	600x500x1070	45

See online for drawer sizes

## Stainless Steel Specific Trolleys

- 304 grade stainless steel construction

### V1544 Specifications:

- Rubber castors - 2 x swivel, 2 x swivel with brakes
- Telescopic height adjustment: 850-1400mm
- Removable Tray Size: 600x400x20mm

### V1545 Specifications:

- A strong and portable oxygen bottle trolley to suit D size cylinders.
- Features a chain to secure bottle
- Rubber castors - 2 x swivel, 2 x swivel with brakes



V1544



V1545

Code	Details	Overall Size (mm)	Castors (mm)
V1544	Instrument Table / Trolley	600x400x20	65
V1545	Oxygen Trolley (with Safety Chain)	380x270x1000	95



## Stainless Steel Platform Trolleys

- Heavy duty stainless steel platform trolley which is great for use in food and medical areas.
- Fixed handle
- 304 grade stainless steel
- Rubber castors - 2 x fixed, 2 x swivel with brakes



V1420



V1421

Code	Load Capacity (kg)	Castors (mm)	Handle Height (mm)	Platform Size (mm)	Platform Height (mm)	Unit Weight (kg)
V1420	600	200	970	910x610	280	41
V1421	600	200	970	1220x610	280	46

## Stainless Steel 2 & 3 Tier Trolleys

- Heavy duty stainless steel 2 and 3 tier trolleys which are great for use in hospitality areas.
- The shelves can be used as a flat platform or turned upside down and used as a tray
- Polyurethane castors - 4 x swivel
- 304 grade stainless steel
- Overall length including handle: 750mm



Top & middle shelf can be used as a tray or platform



V1435



V1430

Code	Details	Load Capacity (kg)	Castors (mm)	Handle Height (mm)	Distance Between Trays (mm)	Tray Size WxDxH (mm)	Platform Size (mm)	Unit Weight (kg)
V1430	2 Tier Trolley	200	100	910	670	600x400x50	655x400	14
V1435	3 Tier Trolley	200	100	910	310	600x400x50	655x400	18

## 4 Tier Stainless Steel Trolley

- The 4 tier stainless steel trolley is the perfect solution for restaurants, hospitals, hair salons, nursing homes etc.
- Grade of stainless: 201
- Polyurethane castors - 2 x swivel, 2 x swivel with brakes



Code	Load Capacity (kg)	Castors (mm)	Height to Top Shelf (mm)	Shelf Size (mm)	Distance Between Shelves (mm)	Overall Size LxWxH (mm)	Unit Weight (kg)
V1440	100	100	1125	825x500	280	910x590x1260	20

## 2 Tier Flat Deck Trolley

- Electro galvanised handle and end frame
- Chipboard shelves covered in stainless steel sheet
- Polyurethane castors - 2 x swivel, 2 x swivel with brakes
- Top Shelf Height: 720mm
- Handle Height: 950mm



Code	Load Capacity (kg)	Castors (mm)	Shelf Size (mm)	Distance Between Shelves (mm)	Overall Size LxWxH (mm)	Unit Weight (kg)
V1445	200	100	760x435	510	840x430x970	21





## 3 Tier Stainless Steel Platform Trolley

- Great for use in restaurants & industrial areas where hygiene is important
- Material: Stainless steel
- Delivered flat packed - easy self assembly.
- Strong, easy-clean stainless steel construction
- Four quiet castors - two with brakes
- Cleverly designed for stability - includes handles for easy positioning



Lip on shelves



Middle shelf can be removed to make a 2 Tier Trolley

Code	Load Capacity (kg)	Space between 3 Tiers (mm)	Overall Size LxWxH (mm)	Unit Weight (kg)
V1436	128	465	855x455x810	14

## Heavy Duty Fully Welded Stainless Steel Tier Trolleys

- Heavy duty stainless steel 2 tier trolleys are ideal for food and medical areas
- Ergonomic handles at both ends
- Optional PVC buffers available
- 304 grade stainless steel
- Rubber castors - 2 x swivel, 2 x swivel with brakes



Lip on shelves



V1431



V1432



PVC Buffer Kit

Code	Details	Load Capacity (kg)	Castors (mm)	Handle Height (mm)	Shelf Size (mm)	Shelf Heights (mm)	Overall Size LxWxH (mm)	Unit Weight (kg)
V1431	2 Tier Trolley	300	125	1095	880x480	325 + 855	1120x540x1095	21
V1432	3 Tier Trolley	300	125	1095	880x480	200+550+900	1120x540x1095	27.5
V1433	PVC Buffer Kit (includes 4 buffers)							

## X Shape Laundry Cart (150L)

- Lightweight trolley which is great for carting linen or waste
- Can be folded when not in use
- Strong vinyl bag
- Rubber castors - 4 x swivel



Bag is looped over handles and secured with clips



Code	Code	Load Capacity (kg)	Volume (L)	Castors (mm)	Overall Size LxWxH (mm)	Unit Weight (kg)
V9060	Laundry Cart	100	150	100	620x620x995	10
V9061	Replacement Bag to suit X Shape Laundry Cart					

## Plastic X Shape Laundry Cart

- Lightweight trolley which is great for carting linen or waste
- Easily remove the waste bag by unhooking from the frame
- Can be folded when not in use
- Strong vinyl bag
- Rubber castors - 4 x swivel



Bag can easily be removed from the frame



Code	Details	Load Capacity (kg)	Volume (L)	Castors (mm)	Folded Size LxWxH (mm)	Overall Size LxWxH (mm)	Unit Weight (kg)
V9070	Laundry Cart	60	178	75	660x440x1100	690x660x950	10
V9071	Replacement Bag to suit Plastic X Shape Laundry Cart						



## Mesh Trolley with Folding Lid

- The Mesh Trolley with Folding Lid is the perfect solution for hospitals, laundries and nursing homes etc.
- Lockable lid ensures that goods can be stored securely in high traffic areas
- White powder coated finish
- Polyurethane castors - 4 x swivel



Code	Load Capacity (kg)	Castors (mm)	Basket Size LxWxH (mm)	Overall Size LxWxH (mm)	Unit Weight (kg)
V1680	100	100	770x570x430	800x600x915	18

## 3 Basket Office Trolley

- Great for storing small parts and items neatly in the office
- Supplied with plastic baskets as pictured
- Integrated frame handles
- Plastic Basket Size (LxWxH): 510x360x200mm
- Nylon castors - 2 x swivel, 2 x swivel with brakes



3 removable nesting baskets included



Code	Load Capacity (kg)	Castors (mm)	Shelf Size (mm)	Overall Size LxWxH (mm)	Unit Weight (kg)
V1525	50	100	500x400	520x470x1085	11



## 2 Tier Utility Service Carts

- Heavy duty plastic construction which resists dents, chips and rust
- Polypropylene handles with aluminium frames
- Sturdy and stable but lightweight making it easy to manoeuvre
- Rubber castors 100mm (2 x swivel, 2 x swivel with brakes)



Code	Details	Load Capacity (kg)	Shelf Size (mm)	Overall Size LxWxH (mm)	Unit Weight (kg)
V1480	2 Tier Utility Cart	250	680x450	860x480x950	9
V1483	Drawer Unit with Lock to suit				5



## Large 2 Tier Utility Cart

- Heavy duty plastic construction which resists dents, chips and rust
- Polypropylene handles with aluminium frames
- Sturdy and stable but lightweight making it easy for manoeuvrability
- Rubber Castors - 2 x fixed, 2 x swivel with brakes

Code	Load Capacity (kg)	Castors (mm)	Shelf Size (mm)	Overall Size LxWxH (mm)	Unit Weight (kg)
V1481	250	100	915x520	1100x500x950	13

## 2 Tier Utility Cart (With Sides)

- Heavy duty plastic construction which resists dents, chips and rust
- Polypropylene handles with aluminium frames
- Sturdy and stable but lightweight making it easy to manoeuvre
- These utility carts have the added benefit of polypropylene side panels
- Rubber castors - 2 x swivel, 2 x swivel with brakes



Code	Details	Load Capacity (kg)	Castors (mm)	Shelf Size (mm)	Overall Size LxWxH (mm)	Unit Weight (kg)
V1482	Large 2 Tier Utility Cart	250	100	680x450	850x480x950	11
V1483	Drawer Unit with Lock to suit V1482					



### 3 Tier Utility Carts

- Heavy duty plastic construction which resists dents, chips and rust
- Polypropylene handles with aluminium frames
- Sturdy and stable but lightweight making it easy to manoeuvre
- Rubber castors - 2 x swivel, 2 x swivel with brakes



V1451



V1452

Code	Details	Load Capacity (kg)	Castors (mm)	Shelf Size (mm)	Overall Size LxWxH (mm)	Unit Weight (kg)
V1451	3 Tier Utility Service Trolley (Narrow)	180	75	485x365	660x380x900	6
V1452	3 Tier Utility Service Trolley	180	100	615x450	810x500x970	10



V1455



V1456

### Utility Carts (With Side Panels)

- These utility carts have the same specifications as the other 3 tier utility carts with the added benefit of polypropylene side panels
- Rubber castors - 100mm (2 x swivel, 2 x swivel with brakes)

Code	Details	Load Capacity (kg)	Shelf Size (mm)	Overall Size LxWxH (mm)	Unit Weight (kg)
V1455	3 Tier Utility Trolley (with sides)	250	680x450	870x500x1010	15
V1456	Extra Long 3 Tier Service Trolley (with sides)	250	920x520	1110x520x1010	21
V1483	Drawer Unit with Lock to suit V1455 only				

### 3 Tier Service Cart

- Heavy duty plastic construction which resists dents, chips and rust
- Polypropylene handles with aluminium frames
- Sturdy and stable but lightweight making it easy to manoeuvre
- Lockable front doors
- Rubber castors - 100mm (2 x swivel, 2 x swivel with brakes)
- Internal size of the cabinets (LxDxH): 670x450x65mm
- Internal size of the top tray (LxDxH): 680x450x65mm



Code	Load Capacity (kg)	Load Capacity of Top Shelf (kg)	Shelf Size (mm)	Overall Size LxWxH (mm)	Unit Weight (kg)
V1461	250	125	680x450	870x500x1010	17

## 2 Tier Plastic Utility Cart (with Ergonomic Handle)

- Heavy duty plastic construction
- Built in storage bin in the handle which is great for storing small parts or tools
- Ergonomic handle design
- Round corners which avoid marking of walls and furniture from sharp edges
- Rubber castors - 2 x fixed, 2 x swivel



Code	Load Capacity (kg)	Castors (mm)	Platform Heights (mm)	Tray Size LxWxH (mm)	Overall Size LxWxH (mm)	Unit Weight (kg)
V1415	250	125	150 + 850	920x625x70	1110x650x990	22.4

## 3 Tier Plastic Utility Cart (with Ergonomic Handle)

- Heavy duty plastic construction
- Built in storage bin in the handle which is great for storing small parts or tools
- Ergonomic handle design
- Round corners which avoid marking of walls and furniture from sharp edges
- Distance between shelves with middle shelf is 200mm
- Rubber castors - 2 x fixed, 2 x swivel



Code	Load Capacity (kg)	Castors (mm)	Platform Heights (mm)	Tray Size LxWxH (mm)	Overall Size LxWxH (mm)	Unit Weight (kg)
V1417	250	125	150, 475 & 850	920x625x70	1110x650x990	25.4





## 3 Tier Utility Cart

- Versatile functional carts for food service, catering etc
- Lightweight, strong, reinforced polymer construction with aluminium posts
- Rubber castors - 4 x swivel
- Spacing between shelves: 340mm



Code	Load Capacity (kg)	Castors (mm)	Handle Height (mm)	Shelf Size (mm)	Overall Size LxWxH (mm)	Unit Weight (kg)
V1450	150	75	910	600x430	845x430x910	10

## 3 Tier Utility Service Cart

- Heavy duty plastic construction which resists dents, chips and rust.
- Supplied standard with 2 removable buckets
- Small bucket size (LxWxH): 360x290x360mm
- Large bucket size (LxWxH): 360x290x560mm
- Polyurethane castors - 2 x fixed, 2 x swivel with brakes
- Top Shelf Size (Internal): 450x740mm



Code	Load Capacity (kg)	Castors (mm)	Overall Size LxWxH (mm)	Unit Weight (kg)
V7100	250	100	1395x520x975	19

## Service Cart With Side Rails

- Ideal cart for use in restaurants, hospitals, libraries, retail stores, schools.
- Lightweight trolley yet very robust design
- Electro galvanised finish
- Rubber castors - 2 x swivel, 2 x swivel with brake
- Distance between shelves: 325mm



Code	Load Capacity (kg)	Castors (mm)	Height to Top Shelf (mm)	Tray Size LxWxH (mm)	Overall Size LxWxH (mm)	Unit Weight (kg)
V1037	250	125	705	935x535x90	1130x550x940	24

## Folding Hand Truck (125kg Capacity)

- Great lightweight hand trucks for general load carting
- Folds completely flat as pictured
- Foot Size: 485x350mm



Code	Load Capacity (kg)	Open Size LxWxH (mm)	Folded Size LxWxH (mm)	Unit Weight (kg)
V1177	125	500x520x1070	490x65x770	7.5

## Folding Hand Truck (68kg Capacity)

- Great lightweight hand trucks for general load carting
- Folds completely flat as pictured
- Foot Size: 390x280mm
- The V1178 trolley has a clip on attachment to fit the V-Cart folding basket
- See V-Cart basket details on page 8

The V1178 trolley fits the V-Cart folding crate



Code	Load Capacity (kg)	Open Size LxWxH (mm)	Folded Size LxWxH (mm)	Unit Weight (kg)
V1178	68	400x400x1000	385x55x635	3.3

## Folding Hand Trolley

- Extremely light weight folding hand trolley
- Foot Plate folds up and handle collapses for easy storage when not in use
- Rubber castors
- Castors: 150mm
- Foot Plate Size (WxDx): 355x240mm

Code	Load Capacity (kg)	Closed Size WxDxH (mm)	Open Size WxDxH (mm)	Unit Weight (kg)
V1170	90	390x410x1090	390x410x1090	6





## 150kg Capacity Aluminium Hand Trolley

- Great lightweight hand truck for general load carting
- Pneumatic tyres



Plastic covered handle



Sturdy base plate



Code	Load Capacity (kg)	Castors (mm)	Foot Plate Size WxD (mm)	Open Size WxDxH (mm)	Unit Weight (kg)
V1190	150	260	355x180	520x470x1260	10

## Aluminium Convertible Hand Trolleys

- Lightweight Aluminium Convertible Hand Trolleys
- Quickly convert from a 2 wheel upright trolley to a 4 wheel platform trolley
- Load Capacity: two wheels status: 200kg; four wheels status: 250kg
- Large wheel size: 260mm
- Rubber castor wheel size: 125mm



V1180



V1181



V1180

V1181

Code	Details	Foot Plate Size WxD (mm)	Vertical Size WxDxH (mm)	Horizontal Size WxDxH (mm)	Unit Weight (kg)
V1180	1320mm High	460x180	500x470x1320	1120x500x1030	17
V1181	1560mm High	460x180	500x470x1560	1450x500x1140	19



## Heavy Duty Appliance Trolleys

- Industrial quality hand trolleys to suit a variety of applications
- Powdercoated steel frame with poly load protectors
- V1250 + V1255 are supplied with appliance strap



V1250



V1255



V1257

Code	Details	Load Capacity (kg)	Foot Size WxD (mm)	Overall Size WxH (mm)	Unit Weight (kg)
V1250	Appliance Trolley - Stair Climber	350	450x200	610x1520	22
V1255	Appliance Trolley - Flat Free	350	450x200	610x1520	19
V1257	P Handle Trolley with extended Foot - Flat Free	300	350x240	525x1305	15

## Keg Trolley

- Highly manoeuvrable
- Suits all Australian kegs
- Ergonomically designed to prevent back strain
- Standard unit fitted with solid 250mm polyurethane wheels
- Overall Size (WxH): 530x1150mm
- Tyre Type: Solid Polyurethane
- Castors: 250mm



Trolley pictured without Keg



Code	Load Capacity (kg)	Overall Size WxDxH (mm)	Unit Weight (kg)
V1212	100	530x1150	10



## Court / Solicitors File Trolleys

- These steel basket court trolleys are ideal for solicitors documents
- The trolley has 3 separate levels which are designed specially to fit lever arch files
- Optional rain cover also available as pictured
- Court trolleys are supplied assembled ready for immediate use
- The 2 shelves fold back which gives more space for larger items and boxes
- Available with solid or pneumatic wheels
- Shelf Depth: 340mm
- Load Capacity: 200kg
- 50kg Folding Shelf
- Handle Height: 1115mm



**V1162**  
Vinyl Rain Cover



**V1160**  
Solid Tyres



**V1161**  
Pneumatic Tyres

Code	Details	Front Castors (mm)	Rear Castors (mm)	Overall Size LxWxH (mm)	Unit Weight (kg)
V1160	Court Trolley - Solid Rear Wheels	80	250	620x640x1160	20
V1161	Court Trolley - Pneumatic Rear Wheels	80	270	620x740x1160	20
V1162	Vinyl Rain Cover to suit Court Trolleys				

## Gas Cylinder Trolleys

- Ideal for transporting gas cylinders
- Supplied with securing chains as pictured



**V1210**  
Single Cylinder Trolley



**V1211**  
Double Cylinder Trolley

Code	Details	Castors (mm)	Cylinder Size Dia. (mm)	Overall Size WxDxH (mm)	Unit Weight (kg)
V1210	Single Cylinder Trolley	200	140-250	600x600x1360	17
V1211	Double Cylinder Trolley	390	140-250 x 2	700x700x1380	44

## Gas Cylinder Trolley Cage

- Suitable for oxygen and acetylene gas cylinders with provision to store hoses inside the cage
- Craneable trolley designed to carry one type "G" Oxygen and one type "G" Acetylene gas cylinder
- Supplied with an internal load binder to securely fasten both cylinders
- Fitted with a handle, crane lift point and 400mm diameter air inflated rubber wheels
- Supplied with 1T crane lifting sling
- Enamel paint finish
- HGC: 167mm
- Supplied flatpacked



Rubber air filled wheels



Code	Safe Working Load (kg)	Load Centre (mm)	Fork Pocket Size (mm)	Fork Pocket Centres (mm)	Overall Size LxWxH (mm)	Unit Weight (kg)
V1215	250	202	165x45	480	882x615x1371	55

## Pipe Trolley

- Heavy duty construction for maximum stability
- 8 spaces available for sorting and accessing pipes
- Arm stops prevent items falling off
- 4 corner posts supplied for fitting to base frame
- Poly/cast wheels - 2x fixed, 2x swivel with brakes
- Zinc finish

Designed for long length materials such as pipe and conduit



Code	Working Load Limit (kg)	Castors (mm)	Overall Size LxWxH (mm)	Unit Weight (kg)
V1280	2000	150	1895x1065x1790	112





# Galvanised Drum Trolley with Bund

- This trolley is designed to carry 1 drum which is mounted on the rack provided for easy dispensing
- The bin tray has a drain plug for draining the bin
- Finish: Galvanised

Trolley doesn't come with the drum



Code	Spill Bin Capacity (L)	Working Load Limit (kg)	Dimensions LxWxH (mm)	Unit Weight (kg)
V7583	230	1000	1245x730x510	50

## YOU MAY ALSO LIKE OUR CONTAINMENT STORAGE SOLUTIONS



See page 273



See page 281

## Timber Deck Wagon Platform Truck

- Swivel handled platform truck for moving and turning easily
- The platform is reinforced with steel cross bars for extra strength
- Heavy duty timber platform
- Powder coated blue
- Rubber castors - 2 x fixed, 2 x swivel



Code	Load Capacity (kg)	Castors (mm)	Handle Height (mm)	Platform Size (mm)	Overall Size LxWxH (mm)	Unit Weight (kg)
V1060	700	250	1100	1200x700	1200x700x1100	60

## Wagon Platform Truck (With Sides)

- Swivel handled platform truck for moving and turning easily
- Timber floor and side panels
- The platform is reinforced with steel cross bars for extra strength
- Powder coated blue
- Side Panel Height: 610mm
- Rubber castors - 2 x fixed, 2 x swivel



Code	Load Capacity (kg)	Castors (mm)	Handle Height (mm)	Platform Height (mm)	Platform Size (mm)	Overall Size LxWxH (mm)	Unit Weight (kg)
V1061	700	250	1100	410	1200x700	1440x700x1100	76

## All Terrain Platform Trolley

- The All Terrain Platform Trolley is perfect for construction sites and general warehouse use
- Heavy duty trolley construction
- Handle activated brake
- Swivel handle for steering the trolley
- Powder coated frame with plywood deck
- Optional sides available
- Internal Size (LxW) when Side Panels are added: 1120x610mm
- 4 x pneumatic wheels with steel rim



Code	Details	Static Load Capacity (kg)	Dynamic Load Capacity (kg)	Castors (mm)	Overall Size LxWxH (mm)	Unit Weight (kg)
V1063	All Terrain Platform Trolley	1300	650	300	1200x690x397	49
V1064	Optional Sides to suit All Terrain Platform Trolley (300mm high)					



## A Frame Trolleys for Glass

- Suitable for storing & transporting glass, stone & other sheet materials
- Load is secured by 4 adjustable clamp bars
- Detachable ratchet straps supplied
- Rubber profiles protect the load from damage and help prevent movement
- Heavy duty A Frame construction for max. stability
- 150mm poly wheels with brakes allow easy manoeuvring around the worksite
- Wheel kit is designed for quick release with a provision for storage when not in use
- V1279 base is sized (800mm) to use less space on a ute tray and fit through a standard doorway
- V1281 base is designed with racking locators to suit storage in highbay racking
- Zinc finish



4-way fork access & crane lugs for transport by forklift or crane

Code	Details	Maximum Load Width (mm)	Fork Pocket Size (mm)	Overall Size LxWxH (mm)	Unit Weight (kg)
V1279	A-Frame Trolley for Glass - 1500mm long	215	250x80	1500x800x1620	105
V1281	A-Frame Trolley for Glass - 1800mm long	340	250x80	1800x1150x1620	130

## Steel Triangular Frame Panel Cart

- Triangular framed panel cart is used for transporting heavy items in warehouses such as plasterboard, mattresses etc.
- Bolt together construction
- Comes with 2 fixed castors and 2 swivel castors with brakes
- Load Capacity with pneumatic castors: 200kg
- Castors: 150mm
- Front Platform Height: 330mm
- Back Platform Height: 220mm



Code	Details	Load Capacity (kg)	Platform Size (mm)	Overall Size LxWxH (mm)	Unit Weight (kg)
V1230	Steel Triangular Panel Cart	500	380x1200	580x1200x1160	40
V1845	Pneumatic Wheel Kit to suit V1230				



## Panel Cart with Adjustable Load Bars

- The Panel Cart is ideal for moving long/bulky products
- Bars can be set at different spacing so that a variety of different sized products can be transported.
- Zinc finish
- Polyurethane castors - 2 x fixed, 2 x swivel with brakes
- Supplied standard with 2 load bars, but can be fitted with up to 5 bars at once
- Range of accessories available to suit (see page 53)



Optional Accessories available to suit - page 53

Code	Load Capacity (kg)	Castors (mm)	Base Height (mm)	Overall Size LxWxH (mm)	Unit Weight (kg)
V1293	1000	160	240	1250x700x1050	47.5

## Panel Cart with Adjustable Load Bars (Pneumatic Wheels)

- The Panel Cart is ideal for moving long/bulky products
- Bars can be set at different spacing so that a variety of different sized products can be transported.
- Zinc finish
- Pneumatic Wheels - 2 x fixed, 2 x swivel with brakes
- Supplied standard with 2 load bars, but can be fitted with up to 5 bars at once
- Range of accessories available to suit (see page 53)



Optional Accessories available to suit - page 53

Code	Load Capacity (kg)	Wheels (mm)	Base Height (mm)	Overall Size LxWxH (mm)	Unit Weight (kg)
V1294	300	200	280	1250x700x1090	45



## A Frame Panel Cart

- The A frame panel trolley is ideal for transporting bulky items
- Optional trestle racks so that long product can be stored at different heights
- Zinc Finish
- Polyurethane castors - 2 x fixed, 2 x swivel with brakes
- Castors: 160mm
- Range of accessories available to suit (see page 53)

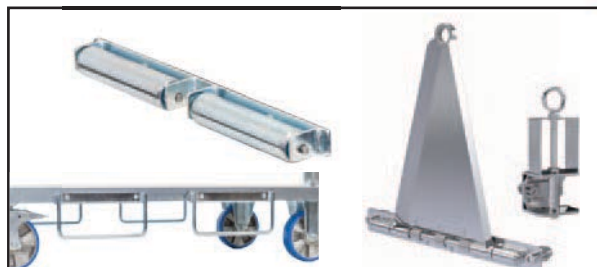

Optional Accessories available to suit - page 53



V1295



V1295K

Code	Details	Load Capacity (kg)	Base Height (mm)	Overall Size LxWxH (mm)	Unit Weight (kg)
V1295	A Frame Panel Cart	1000	240	1250x700x1350	55.5
V1295K	A Frame Panel Cart with Trestle Racks	1000	240	1250x700x1350	60.5

## A Frame Panel Cart (Pneumatic Wheels)

- The A frame panel trolley is ideal for transporting bulky items
- Optional trestle racks so that long product can be stored at different heights
- Zinc Finish
- Pneumatic 200mm Wheels - 2 x fixed, 2 x swivel with brakes
- Range of accessories available to suit (see page 53)



Optional Accessories available to suit - page 53



V1296



V1296K

Code	Details	Load Capacity (kg)	Base Height (mm)	Overall Size LxWxH (mm)	Unit Weight (kg)
V1296	A Frame Panel Cart	300	280	1250x700x1390	53
V1296K	A Frame Panel Cart with Trestle Racks	300	280	1250x700x1390	68

## Transport Trolley with Storage Tray

- Ideal for transporting large and bulky items
- Storage tray is ideal for transporting smaller items
- Zinc Finish
- Polyurethane castors - 2 x fixed, 2 x swivel with brakes
- Tray Size (LxWxH): 1120x200x200mm
- Range of accessories available to suit (see page 53)



Optional Accessories available to suit - page 53



Code	Load Capacity (kg)	Castors (mm)	Base Height (mm)	Overall Size LxWxH (mm)	Unit Weight (kg)
V1297	1000	160	240	1250x700x1155	53

## Transport Trolley with Storage Tray (Pneumatic Wheels)

- Ideal for transporting large and bulky items
- Storage tray is ideal for transporting smaller items
- Zinc Finish
- Pneumatic Wheels - 2 x fixed, 2 x swivel with brakes
- Tray Size (LxWxH): 1120x200x200mm
- Range of accessories available to suit (see page 53)



Optional Accessories available to suit - page 53



Code	Load Capacity (kg)	Wheels (mm)	Base Height (mm)	Overall Size LxWxH (mm)	Unit Weight (kg)
V1298	300	200	280	1250x700x1390	51





# Accessories to suit Panel Carts

- Range of accessories to suit the zinc panel trolleys
- All accessories have a Zinc finish



Scan QR code to see more information online



Code	Details	V1293	V1294	V1295	V1296	V1297	V1298
V1284	High Load Bar	Y	Y	-	-	Y	Y
V1285	Low Load Bar	Y	Y	-	-	Y	Y
V1287	Side Panels	Y	Y	-	-	Y	Y
V1291	Entry Rollers	Y	Y	Y	Y	Y	Y
V1292	Add-On Tray with one Load Bar	Y	Y	-	-	-	-
V1916	Fork Pockets (set of 2)	Y	Y	Y	Y	Y	Y
V1920	Trolley Towing Set	Y	Y	Y	Y	Y	Y

## Plastic Bin Trolley (Blue)

- Heavy duty rotomoulded bin with 25mm steel tubular frame
- Bin is ribbed for extra strength
- Additional bins are available to purchase
- 280L Internal Top Dimension (WxL): 910x615mm
- 400L Internal Top Dimension (WxL): 1170x650mm
- 280L Height From Ground To Top Rim: 740mm
- 400L Height From Ground To Top Rim: 790mm
- Nylon castors - 2 x fixed, 2 x swivel
- Load Capacity: 400kg



Tub to suit



Bin Trolley

Code	Details	Internal Base Size (mm)	Overall Size LxWxH (mm)	Unit Weight (kg)
V1270B	Blue 280L Capacity Bin Trolley (Includes Bin)	-	1170x730x800	25
V1271	Blue 280L Capacity Tub	500x780	1030x730x600	8.5
V1273B	Blue 400L Capacity Bin Trolley (Includes Bin)	-	1400x710x850	44
V1274	Blue 400L Capacity Tub	1040x540	1280x780x640	12.6

## Plastic Bin Trolley (White)

- Heavy duty rotomoulded bin with 25mm steel tubular frame
- Bin is ribbed for extra strength
- Additional bins are available to purchase
- 280L Internal Top Dimension (WxL): 910x615mm
- 400L Internal Top Dimension (WxL): 1170x650mm
- 280L Height From Ground To Top Rim: 740mm
- 400L Height From Ground To Top Rim: 790mm
- Nylon castors - 2 x fixed, 2 x swivel
- Load Capacity: 400kg



Tub to suit



V1270W

V1273W

Code	Details	Internal Base Size (mm)	Overall Size LxWxH (mm)	Unit Weight (kg)
V1270W	White 280L Capacity Bin Trolley (Includes Bin)	-	1170x730x800	25
V1272	White 280L Capacity Tub	500x780	1030x730x600	8.5
V1273W	White 400L Capacity Bin Trolley (Includes Bin)	-	1400x710x850	44
V1275	White 400L Capacity Tub	1040x540	1280x780x640	12.6



## 350L Waste Collection Trolley

- Great for use in warehouses and on sites, for general waste and rubbish
- Pull handle which releases the bin forward
- Rubber wheels - 2 x fixed, 1 x swivel



View video of this in operation here:  
[www.verdex.com.au/V6300](http://www.verdex.com.au/V6300)



Code	Load Capacity (kg)	Bin Capacity (L)	Front Wheel Size (mm)	Rear Wheel Size (mm)	Bin Size LxWxH (mm)	Unit Weight (kg)
V6300	350	350	340	125	1350x850x1040	72

## Forklift Waste Tipping Bin

- This light weight fork waste bin is great for use in warehouses and on sites for general waste and rubbish
- Fitted standard with 2 front wheels and 1 rear wheel
- Simply pull the cord or handle which releases mechanism for tipping into larger bins or skips
- Painted finish
- Polyurethane castors - 2 x fixed, 1 swivel with brake



Code	Castors (mm)	Load Capacity (kg)	Bin Capacity (L)	Fork Pocket Size (mm)	Fork Pocket Centres (mm)	Height to Top of Lip (mm)	Overall Size LxWxH (mm)	Unit Weight (kg)
V6000	125	500	150	140x55	600	710	1160x750x805	95



# DISCOVER OUR VERDEX BIN TIPPERS 3 VARIATIONS AVAILABLE



See pages 252, 253 & 254



## Scooter Stock Picker

- The Scooter Stock Picker is the ideal product for moving stock in large warehouses
- Comes standard with single base shelf
- Optional extra shelf, clipboard writing panel and cage basket available to suit
- Rubberized handles for ergonomic grip.
- Base plate with Antislip surface.
- Bell on handle to alert people
- Rubber surround on base shelf
- Rubber wheels - Rear wheel has brake



V1841Z



V1721



Pictured with cage basket (V1723)

Code	Details	Capacity (kg)	Wheels (mm)	Overall Size LxWxH (mm)	Unit Weight (kg)
V1720	Scooter Stock Picker	200	200	1470x70x1020	42
V1721	Optional Shelf (used to make a 2nd tier)			520x610 (LxW)	8
V1841Z	Optional Clipboard Writing Panel			340x248 (LxW)	2
V1723	Optional Cage Basket			541x645x535	7

## Ezi Mover Trolley

- The Ezi Mover trolley is great for both indoor or outdoor use
- Black powder coated frame which fits 3 bin sizes
- Trolley shown with bin which is sold separately (see page 115 for bins)
- Rear pneumatic wheel and rubber front castor



Code	Load Capacity (kg)	Front Castor (mm)	Rear Wheels (mm)	Height to top lip (mm)	Overall Size LxWxH (mm)	Unit Weight (kg)
V1615	70	125	260	790	1025x607x955	10

## Order Picking Trolleys

- Single and double order picking trolleys
- Heavy duty warehouse order picking trolley which is ideal for order picking and other applications
- Simple bolt together construction
- Powder coated finish
- Rubber castors - 2 x swivel, 2 x swivel with brakes
- Handle Height: 1050mm
- Top Rail Height: 1000mm
- Bottom Shelf Height: 230mm
- Range of accessories available to suit
- Single Tub Trolley (V1610) fits 1 tub
- Double Tub Trolley (V1611) fits 2 tubs
- Trolleys fit either No.7, No. 10 and No.15. Plastic tubs are sold separately which are available in 6 colours (black, blue, green, red, white and yellow)

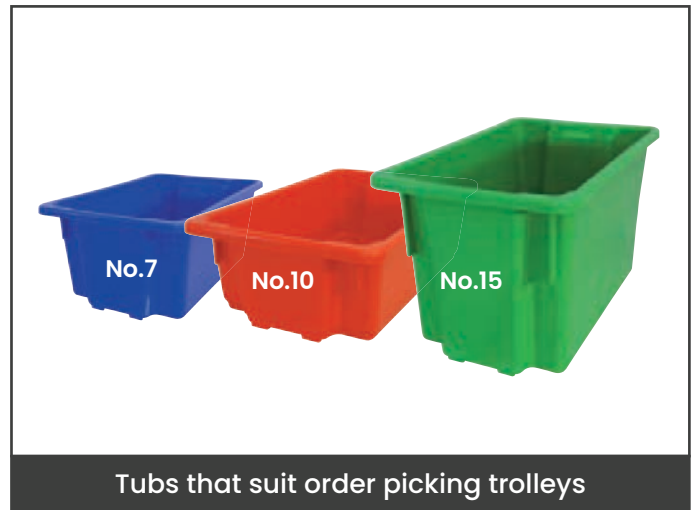

Tubs that suit order picking trolleys



Single Order Picking Trolley



Double Tub Order Picking Trolley



V1610K pictured with V1842 Laptop Holder & V1843 Mesh Basket Accessory Tray



V1611K pictured with V1841 Clipboard Holder & V1843 Mesh Basket

Code	Details	Load Capacity (kg)	Castors (mm)	Overall Size LxWxH (mm)	Unit Weight (kg)
V1610	Single Order Picking Trolley	250	125	835x425x1050	16
V1610K	Single Order Picking Trolley Kit*	250	125	835x425x1050	17
V1611	Double Tub Order Picking Trolley	250	125	1010x650x1050	21
V1611K	Double Tub Order Picking Trolley Kit**	250	125	1010x650x1050	23

\* Kit supplied with 1x No. 10 Red Plastic Tub

\*\* Kit supplied with 1x No. 10 Red Plastic Tubs





## Twin Offset Tub Order Picking Trolley

- Heavy duty warehouse order picking trolley which is ideal for order picking and other warehouse applications
- Simple bolt together construction
- Powder coated finish
- Rubber castors - 2 x swivel, 2 x swivel with brakes
- Range of accessories available to suit
- Fits 2 tubs in either No.7, No. 10 and No.15. Plastic tubs are sold separately which are available in 6 colours (black, blue, green, red, white and yellow)



Code	Details	Load Capacity (kg)	Castors (mm)	Overall Size LxWxH (mm)	Unit Weight (kg)
V1612	Twin Offset Tub Trolley	250	125	1050x450x1300	15
V1612K	Twin Offset Tub Trolley Kit*	250	125	1050x450x1300	18

\* Kit supplied with 2x No. 10 Red Plastic Tubs

## Accessories to suit Order Picking Trolleys



Drink Bottle Holder



Clipboard Holder



Laptop & RF Holder



Mesh Basket



Accessory Shelf



A4 Pocket



Scanner Holder

Code	Details
V1840	Drink / Water Bottle Holder
V1841	Clipboard Holder
V1842	Laptop & RF Holder
V1843	Mesh Basket
V1844	Accessory Shelf
V1848	A4 Pocket
V1849	Scanner Holder

## 2 Tier Tool Trolley (With Drawers)

- Twin drawers with ball bearing sliders and quick return system
- Top drawer depth: 60mm
- Internal Drawer Size (WxDxH): 600x400x45mm
- Bottom drawer depth: 80mm
- Rubber castors - 2 x swivel, 2 x swivel with brakes



Code	Load Capacity (kg)	Castors (mm)	Shelf Size (mm)	Overall Size LxWxH (mm)	Unit Weight (kg)
VI485	250	100	680x450	870x500x950	20

## Triple Deck Tool Cart (With Tool Board & Drawer)

- Single drawer with ball bearing sliders and quick return system
- Hooks sold separately
- Side can holder and tray supplied
- Drawer depth: 80mm
- Rubber castors - 2 x swivel, 2 x swivel with brakes
- Castors: 100mm



Code	Load Capacity (kg)	Shelf Size (mm)	Overall Size LxWxH (mm)	Unit Weight (kg)
VI465	250	680x450	900x500x1430	25

## 3 Tier Tool Trolley (With Drawer)

- Single drawer with ball bearing sliders and quick return system
- Drawer depth: 80mm
- Rubber castors - 2 x swivel, 2 x swivel with brakes
- Castors: 100mm



Code	Load Capacity (kg)	Shelf Size (mm)	Overall Size LxWxH (mm)	Unit Weight (kg)
VI460	250	680x450	780x500x1010	15



## 3 Tier Aluminum Framed Computer Cart

### (With Slide Out Shelf)

- These computer carts are great for both office and warehouse use
- Rubber castors - 2 x swivel, 2 x swivel with brakes
- Shelf Size: 620x450mm



Code	Load Capacity (kg)	Castors (mm)	Overall Size LxWxH (mm)	Unit Weight (kg)
V1470	250	100	810x510x1160	18

## 3 Tier Steel Computer Cart

- These computer carts are great for both office and warehouse use
- An excellent choice for organizations seeking a reliable and flexible solution for managing computer equipment
- Rubber castors - 2 x swivel, 2 x swivel with brakes
- Quality swivel castors (2 with brakes)



Code	Load Capacity (kg)	Castors (mm)	Shelf Size (mm)	Overall Size LxWxH (mm)	Unit Weight (kg)
V1472	250	100	610x460	610x520x910	28

## Quad Deck Tool Cart

### (With Tool Board)

- Excellent tool cart with square hole pegboard
- Supplied with accessories
- Tray depth: 50mm
- Nylon castors - 2 x swivel, 2 x swivel with brakes
- Castors: 100mm
- Shelf Size: 585x405mm



Code	Load Capacity (kg)	Overall Size LxWxH (mm)	Shelf Heights (mm)	Unit Weight (kg)
V1466	300	680x430x1215	170 + 370 + 570 + 770	24



## Furniture Mover Set

- Great for moving heavy furniture and equipment
- Winch handle geared mechanism
- Non marking castors
- Sold as a set of 2 only
- Ratchet straps are included

V1225 pictured with V7200  
1/2 Height Cabinet



Code	Load Capacity (kg)	Castors (mm)	Lifting Height (mm)	Lifting Plate Size (mm)	Overall Size LxWxH (mm)	Unit Weight per Set of 2 (kg)
V1225	600	150	300	120x225	570x390x825	34

## Flat Equipment Moving Dollies

- Great for moving furniture and equipment due to their low height and high capacity
- Both models come with 4 heavy duty swivel castors
- **V1219** is made from polypropylene with steel tubing. Rubber moulds on each end to protect items from scatching and marking. Supplied with nylon castors
- **V1220** has a non slip vinyl platform with a PVC bumper strip around the edge.
- Supplied with polyurethane castors.



Code	Details	Load Capacity (kg)	Castors (mm)	Overall Size LxWxH (mm)	Unit Weight (kg)
V1219	Flat Equipment Moving Dolly	350	75	765x460x130	6
V1220	Flat Platform Steel Dolly	370	125	920x620x180	15



# Chair Trolley

- Lifts and moves stacks of chairs with ease
- Fitted Rubber Pads to protect the chairs
- Powder coated black finish
- Chair Capacity: 10 chairs
- Rubber castors - 2 x large fixed, 2 x swivel



Code	Load Capacity (kg)	Front Wheels (mm)	Rear Castors (mm)	Handle Height (mm)	Overall Size LxWxH (mm)	Unit Weight (kg)
V1208	70	200	75	1120	1230x495x1120	17

## YOU MAY ALSO LIKE OUR LOAD SKATE RANGE



See pages 90-91

## Basket Picking Trolley

- The Basket Picking Trolley is lightweight making it ideal for use in clothing stores, mail rooms & order picking in warehouses
- Two mesh baskets allow various sized items to be moved
- Electro galvanised finish
- Rubber castors - 2 x swivel, 2 x swivel with brake



Code	Load Capacity (kg)	Castors (mm)	Distance Between Baskets (mm)	Size of Lower Basket LxWxH (mm)	Size of Top Basket LxWxH (mm)	Overall Size LxWxH (mm)	Unit Weight (kg)
V1677	100	100	300	605x400x110	605x400x360	690x410x950	13

## Retail Stock Trolley

- The Retail Stock Trolley is ideal for retail applications to move stock between back of house and front of house
- This trolley is also suitable for transferring goods of any type throughout super markets, factories, and any workplace
- Centre wheel kit for turning in tight spaces
- Basket for storage of small items
- Electro galvanised and clear coated
- Rubber castors - 2 x fixed, 4 x swivel



Optional clipboard available

Code	Details	Load Capacity (kg)	Castors (mm)	Height to Top Shelf (mm)	Distance Between Shelves (mm)	Overall Size LxWxH (mm)	Unit Weight (kg)
V1685	Stock Trolley	400	125	715	475	1320x430x1120	24
V1841Z	Optional Clipboard Unit						





## Self Levelling Shelf Trolley

- This trolley has an innovative design in which the top platform automatically adjusts to maintain a safe working height as weight is added or taken off.
- Makes work operations faster, safer and more efficient by reducing manual exertion and bending.
- Ideal for use in supermarkets, liquor and hardware stores
- At 90kg, the platform is at the lowest position.
- Trolleys are nestable for compact storage
- Electro galvanised finish
- Rubber castors - 2 x swivel, 2 x swivel with brake



Code	Load Capacity (kg)	Castors (mm)	Handle Height (mm)	Height to Top Shelf (mm)	Distance Between Shelves (mm)	Overall Size LxWxH (mm)	Unit Weight (kg)
V1690	300	125	995	810	610	960x525x1030	36

## Nestable Basket Trolley

- The Nestable Basket Trolley is ideal for use in supermarkets, liquor and hardware stores
- Top basket can be folded upwards so that multiple trolleys can be nested together when not in use
- Electro galvanised finish
- Rubber castors - 2 x swivel, 2 x swivel with brake



Code	Load Capacity (kg)	Top Shelf Capacity (kg)	Castors (mm)	Handle Height (mm)	Distance Between shelves (mm)	Overall Size LxWxH (mm)	Unit Weight (kg)
V1691	300	100	125	1010	430	870x530x1010	21

## Nesting Roll Cage Trolley

- Nestable A-frame Roll Cage Trolley
- Shelves and sides fold for nesting to increase space efficiency
- Single full size lockable swing door
- Folding shelf for maximum space efficiency
- Finish: Zinc
- Nylon Castors - 2 x swivel with brakes, 2 x fixed
- Shelf Capacity: 125kg
- Shelf Size (WxD): 665x760mm (foldable)
- Distance between shelves: approx: 700mm



Watch a video of this in operation on our website here, [www.verdex.com.au/V1760](http://www.verdex.com.au/V1760)



Code	Load Capacity (kg)	Castors (mm)	Shelf Heights (mm)	Overall Size WxDxH (mm)	Unit Weight (kg)
V1760	250	125	245 + 970	750x850x1750	66

## 2 Sided Roll Cage Trolley

- Ideal for use in retail, e-commerce and warehouse applications.
- This trolley has an open front for easy access to contents inside.
- Optional shelf available (V1762)
- Z base for perfect nesting
- Finish: Zinc
- Nylon castors - 2x fixed, 2x swivel with brakes
- Internal Dimensions (WxDxH): 845x695x1635mm
- Lower level height: 210mm
- Shelf Capacity: 125kg
- Shelf Size: 770x695mm

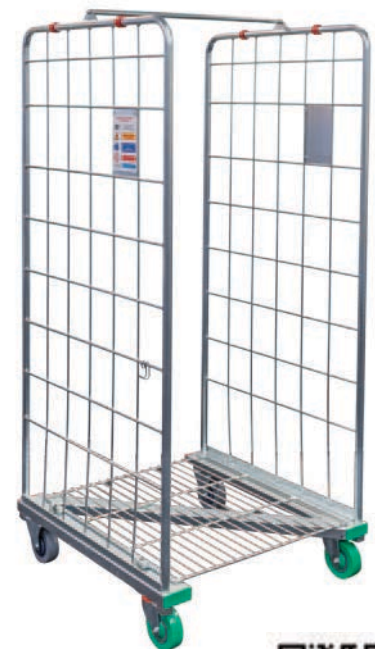

Pictured with 2 extra shelves



Watch a video of this in operation on our website here, [www.verdex.com.au/V1761](http://www.verdex.com.au/V1761)



Code	Details	Load Capacity (kg)	Castors (mm)	Overall Size WxDxH (mm)	Unit Weight (kg)
V1761	2 Sided Roll Cage Trolley	500	125	845x760x1855	44
V1762	Removable Shelf to suit 2 Sided Roll Cage Trolley				4





# 4 Sided Roll Cage Trolley

- Ideal for use in retail, e-commerce and warehouse applications.
- Optional shelf available (V1762)
- This trolley has doors to keep contents secure, making it ideal for front of house.
- Rear of Trolley has 2 half doors
- Front of Trolley has 1 full height door
- Middle shelf is foldable
- Z base for perfect nesting
- Trolleys are Nestable to increase space efficiency
- Finish: Zinc
- Nylon castors - 2x fixed, 2x swivel with brakes
- Lower level height: 210mm
- Shelf Height: 1140mm
- Shelf Size: 770x695mm



Watch a video of this in operation here: [www.verdex.com.au/V1763](http://www.verdex.com.au/V1763)



Code	Details	Load Capacity (kg)	Castors (mm)	Overall Size WxDxH (mm)	Internal Size WxDxH (mm)	Unit Weight (kg)
V1763	4 Sided Roll Cage Trolley	500	125	845x760x1855	770x695x1635	56
V1762	Removable Shelf to suit 4 Sided Roll Cage Trolley					4

## ROLL CAGE TROLLEYS





## Mesh Trolley with Folding Lid & Side

- The Mesh Trolley is able to hold items safely and securely due to the attached lid.
- Foldable side and lid for easy access to products
- Comes with a padlock hook which allows the trolley to be securely locked when not in use
- Mesh Size: 50x50mm
- Electro galvanised finish
- Polyurethane castors - 2 x swivel, 2 x swivel with brakes



Code	Load Capacity (kg)	Castors (mm)	Overall Size LxWxH (mm)	Unit Weight (kg)
V1682	150	100	1180x662x858	28

## Mesh Trolley

- The Mesh Trolley is suitable for holding and storing a large variety of items
- This trolley is ideal for use in warehouses, hospitals, schools and sporting events etc
- Optional lid for storing items securely
- Electro galvanised finish
- Polyurethane castors - 2 x swivel, 2 x swivel with brakes

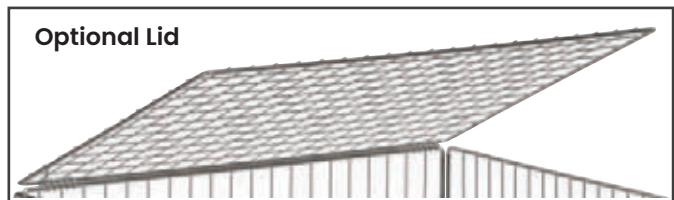

Code	Details	Load Capacity (kg)	Castos (mm)	Overall Size LxWxH (mm)	Unit Weight (kg)
V1683	Mesh Trolley	100	100	830x630x735	18
V1684	Optional Lid for Mesh Trolley				2



# Parcel Trolley with Removable Sides

- This Parcel Trolley is ideal for stock picking and moving boxed products.
- Removable sides for ease of access to platform.
- Adjustable handle height
- Electro galvanised finish with white laminate base
- Rubber castors - 160mm (2 x fixed, 2 x swivel with brakes)
- Load Capacity with pneumatic wheels: 200kg



Clipboard Holder



Flat Free Wheel Kit



Code	Details	Load Capacity (kg)	Overall Size LxWxH (mm)	Unit Weight (kg)
V1675	Parcel Trolley	300	1190x650x1025	36
V1845	Flat Free Wheel Kit - 2 Swivel with Brakes & 2 x Fixed			
V1841Z	Clipboard Holder Attachment to suit V1675			

## YOU MAY ALSO LIKE OUR MESH TRANSPORT STORAGE CAGE



See page 138



### 3 Sided Mesh Cage Trolley

- Simple bolt together construction
- Powder coated blue finish
- Rubber castors - 2 x fixed, 2 x swivel with brakes
- Many accessories available to suit - see page 75
- Mesh Size: 50x50mm
- Load Capacity with standard wheels: 300kg
- Load Capacity with pneumatic wheels: 200kg



Extra shelf available to create 2 tier trolley - See page 75



Accessories available to suit - See page 75

Code	Castors (mm)	Handle Height (mm)	Overall Size LxWxH (mm)	Internal Size LXWxH (mm)	Base Height (mm)	Unit Weight (kg)
V1888	125	1050	1095x660x1050	910x630x690	184	35

### Mesh Cage Trolley with Drop Down Gate

- Simple bolt together construction
- Powder coated blue finish
- Rubber castors - 2 x fixed, 2 x swivel with brakes
- Drop down half gate is removable
- Many accessories available to suit - see page 75
- Mesh Size: 50x50mm
- Load Capacity with standard wheels: 300kg
- Load Capacity with pneumatic wheels: 200kg



Drop down half gate for access to contents



Accessories available to suit - See page 75

Code	Castors (mm)	Handle Height (mm)	Overall Size LxWxH (mm)	Internal Size LXWxH (mm)	Base Height (mm)	Unit Weight (kg)
V1889	125	1050	1095x660x1050	910x630x690	184	45





## Mesh Cage Trolley with Lockable Drop Down Gate & Lid

- Simple bolt together construction
- Powder coated blue finish
- Rubber castors - 2 x fixed, 2 x swivel with brake
- Drop down half gate is removable
- Fold back lid that can be locked if required
- Padlock not included
- Many accessories available to suit - see page 75
- Height to fold down section: 550mm
- Mesh Size: 50x50mm
- Load Capacity with standard wheels: 300kg
- Load Capacity with pneumatic wheels: 200kg



Accessories available to suit - See page 75

Code	Castors (mm)	Handle Height (mm)	Overall Size LxWxH (mm)	Internal Size LXWxH (mm)	Base Height (mm)	Unit Weight (kg)
V1890	125	1050	1095x660x1050	910x605x670	184	48

## Mesh Cage Trolley with Lockable Double Swing Door

- Simple bolt together construction
- Powder coated blue finish
- Rubber castors - 2 x fixed, 2 x swivel with brakes
- Double Swing Door (180 degree opening)
- Many accessories available to suit - see page 75
- Mesh Size: 50x50mm
- Load Capacity with standard wheels: 300kg
- Load Capacity with pneumatic wheels: 200kg

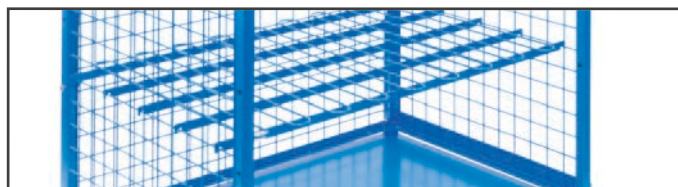

Extra shelf available to create 2 tier trolley



Accessories available to suit - See page 75

Code	Castors (mm)	Handle Height (mm)	Overall Size LxWxH (mm)	Internal Size LXWxH (mm)	Base Height (mm)	Unit Weight (kg)
V1891	125	1050	1095x660x1050	910x605x690	184	44



## Mesh Cage Trolley with Lockable Double Swing Doors & Lid

- Simple bolt together construction
- Powder coated blue finish
- Rubber castors - 2 x fixed, 2 x swivel with brakes
- Fold back lid that can be locked if required
- Padlock not included
- Double Swing Door (180 degree opening)
- Many accessories available to suit - see page 75
- Mesh Size: 50x50mm
- Load Capacity with standard wheels: 300kg
- Load Capacity with pneumatic wheels: 200kg



Accessories available to suit - See page 75

Code	Castors (mm)	Handle Height (mm)	Overall Size LxWxH (mm)	Internal Size LXWxH (mm)	Base Height (mm)	Unit Weight (kg)
V1892	125	1050	1095x660x1050	910x605x670	184	50

## Mesh Cage Trolleys featuring Accessories







## Full Cage Trolley with Double Swing Door

- These steel trolleys are versatile & have a simple bolt together construction.
- Lockable double swing door (180 degree opening)
- Load Capacity with standard castors: 300kg
- Load Capacity with pneumatic castors: 200kg
- Handle Height: 1050mm
- 125mm rubber castors: 2 x fixed & 2 x swivel with brakes
- Overall Shelf Size: 960x655mm
- Internal Tray Size: 905x600mm
- Mesh Size: 50x50mm
- Many accessories available to suit - see page 75



Code	Castors (mm)	Handle Height (mm)	Upper Shelf Height (mm)	Overall Size LxWxH (mm)	Basket Size LxWxH (mm)	Base Height (mm)	Unit Weight (kg)
V1897	125	1050	1573	1095x660x1573	910x605x1355	184	74

## Mesh Cage Trolley with 2 Tiers

- Can be used for a variety of storage & transportation purposes across a range of industries
- 125mm rubber castors: 2 x fixed & 2 x swivel with brakes
- Mesh Size: 50x50mm
- Overall Shelf Size: 960x655mm
- Internal Tray Size: 905x600
- Upper Shelf Height: 1221mm
- Distance between shelves: 337.50mm
- Load Capacity with standard castors: 300kg
- Load Capacity with pneumatic castors: 200kg
- Many accessories available to suit - see page 75



Code	Castors (mm)	Handle Height (mm)	Overall Size LxWxH (mm)	Internal Size LxWxH (mm)	Base Height (mm)	Unit Weight (kg)
V1898	125	1050	1095x660x1211	910x605x670	184	63



# Tiered Steel Cage Trolleys with Red Stack & Nest Tubs

- Stack & Nest Bins can be purchased separately on page \*133



V1897



V1898





## Accessories to suit Mesh Trolleys

- Range of accessories to suit trolleys on pages 70-74



V1840 - Drink Holder



V1841 - Clipboard Holder



V1842 - Laptop &amp; RF Scanner Holder



V1843 - Mesh Basket Accessory Tray



V1844 - Accessory Shelf



V1845 - Pneumatic Wheel Kit

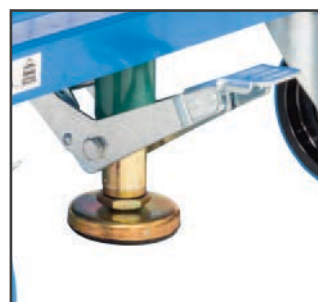

V1846 - Floor Lock Brake



V1848 - A4 Pocket



V1849 - Scanner Holder



V1865 - Ladder &amp; Handle Kit



V1868 - Extra Handle

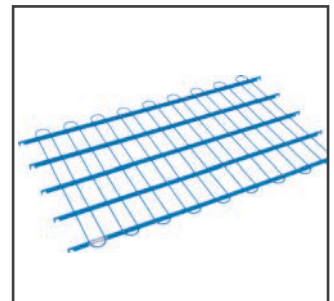

V1869 - Mesh Shelf

Code	Details	Overall Size LxWxH (mm)	Unit Weight (kg)
V1840	Drink Holder	120x120x80	0.54
V1841	Clipboard Holder	340x230x44	1.4
V1842	Laptop & RF Scanner Holder	422x300	2.4
V1843	Mesh Basket Accessory Tray	272x145x187	1.1
V1844	Accessory Shelf	400x100x25	1
V1848	A4 Pocket	310x33x145	1
V1849	Scanner Holder	110x68x145	0.68
V1845	Flat Free Wheel Kit (2 x swivel with brakes & 2 x fixed)	-	-
V1846	Floor Lock Brake	-	-
V1865	Ladder & Handle Kit	670x570x1535	15
V1868	Extra Handle	655x134x225	1
V1869	Mesh Shelf	970x595x25	3.7



## Multi-Purpose Cage Trolleys

- Industrial quality trolleys with cage stop goods falling off the platform
- The cage has fold down sides for easy loading and unloading
- Powder coated steel construction with vinyl platform
- Surround bumper on perimeter of trolley
- Ergonomically designed with handle at optimum height
- Polyurethane castors - 2 x fixed, 2 x swivel



Brake Kit



Clipboard Holder

Code	Details	Load Capacity (kg)	Castors (mm)	Handle Height (mm)	Platform Size (mm)	Platform Height (mm)	Overall Size LxWxH (mm)	Unit Weight (kg)
V1030	Cage Trolley	220	100	1000	750x490	140	820x490x1000	19
V1031	Cage Trolley	370	125	1000	880x580	190	1000x620x1000	27
V1005	Brake Kit to suit V1031							
V1673	Clipboard Holder Attachment to suit V1030 & V1031							

## Extra Large Prestige Platform Trolley (With Cage)

- Wire cage has fold down sides to make loading and unloading easier
- Powder coated steel construction with vinyl decks
- Surround bumper on perimeter of trolley
- Cage Height: 770mm
- Polyurethane castors (2 x fixed, 2 x swivel)
- Optional flat free wheel kit available includes 2 swivel wheels with brakes and 2 fixed wheels
- Platform height with pneumatic wheels: 310mm



Flat Free Wheel Kit



Clipboard Holder

Code	Details	Load Capacity (kg)	Castors (mm)	Handle Height (mm)	Platform Size (mm)	Platform Height (mm)	Overall Size LxWxH (mm)	Unit Weight (kg)
V1032	Platform Trolley	500	200	1000	1170x770	240	1270x770x1000	47
V1845	Flat Free Wheel Kit - Includes 2 Swivel Wheels with Brakes and 2 Fixed Wheels							
V1673	Clipboard Holder Attachment to suit V1032							





## Multi-Purpose 2 Tier Cage Trolleys

- General purpose 2 tier trolleys with wire sides which keep items on platform
- Powder coated steel construction with vinyl decks
- Surround bumper on perimeter of trolley
- Ergonomically designed with handle at optimum height
- Cage can be removed if not required
- Polyurethane castors - 2 x fixed, 2 x swivel



Brake Kit



Clipboard Holder



Code	Details	Load Capacity (kg)	Castors (mm)	Handle Height (mm)	Platform Size (mm)	Platform Height (mm)	Overall Size LxWxH (mm)	Unit Weight (kg)
V1035	2 Tier Trolley	220	100	1010	740x480	140 + 660	790x480x1010	23
V1036	2 Tier Trolley	370	125	1000	920x620	180 + 650	960x620x1000	33
V1005	Brake Kit to suit V1036							
V1673	Clipboard Holder Attachment to suit V1035 & V1036							

## 3 Tier Convertible Cage Trolley

- General purpose 3 tier trolley which can be converted into a platform trolley with sides as pictured
- Rubber castors - 2 x fixed, 2 x swivel with brakes

Image shown with top and middle shelves removed and inserted as sides to convert into a cage trolley



Code	Load Capacity (kg)	Castors (mm)	Handle Height (mm)	Shelf Heights (mm)	Shelf Size (mm)	Overall Size LxWxH (mm)	Unit Weight (kg)
V1085	200	125	1160	190 + 600 + 980	900x600	950x610x1160	45

## Heavy Duty Goods Trolley

- This goods trolley is able to be completely folded when not in use
- Multi-purpose trolley with lockable gates is ideal for transporting goods safely and securely
- Powder coated finish
- Rubber castors - 2 x swivel, 2 x swivel with brakes
- Castors: 125mm
- Optional flat free wheel kit available - 2 x fixed wheels and 2 x swivel wheels with brakes
- Load Capacity with standard wheels: 500kg
- Load Capacity with pneumatic wheels: 200kg
- Internal Size (LxWxH): 1030x720x750mm
- Overall Size (LxWxH): 1085x795x990mm
- Unit Weight: 75kg



Fold out doors for easy access to items inside



Has a small footprint when folded for compact storage when not in use



**Flat Free Wheel Kit**  
(Includes 2 Swivel Wheels with Brakes and 2 Fixed Wheels)



Clipboard Holder Attachment

Code	Details
V1090	Heavy Duty Goods Trolley
V1845	Flat Free Wheel Kit - Includes 2 Swivel Wheels with Brakes and 2 Fixed Wheels
V1841	Clipboard Holder Attachment to suit V1090





# Heavy Duty Goods Trolley with Shelf

- An extremely versatile goods cage with the space saving benefit of being able to be collapsed easily for storage when not in use.
- Fitted with a fold up upper shelf and 270 degree opening lockable gates, this cage can be used in a single or a two shelf configuration.
- Powder coated finish
- Lower Shelf Height Space: 780mm
- Upper Shelf Height Space: 700mm
- Lower Shelf Height: 205mm
- Upper Shelf Height: 1010mm
- Rubber castors - 2 x swivel, 2 x swivel with brake
- Castors: 125mm
- Optional flat free wheel kit available - 2 x fixed wheels, 2 x swivel wheels with brakes
- Load Capacity with standard wheels: 500kg
- Load Capacity with pneumatic wheels: 200kg
- Overall Size (LxWxH): 1100x800x1700mm
- Internal Dimensions (LxWxH): 1034x740x1506mm
- Shelf Size: 1030x750mm
- Unit Weight: 90kg



**Flat Free Wheel Kit**  
(Includes 2 Swivel Wheels with Brakes and 2 Fixed Wheels)



Trolley can be folded for nesting when not in use



Heavy Duty Goods Trolley with Shelf

Code	Details
V1091	Heavy Duty Goods Trolley With Shelf
V1845	Flat Free Wheel Kit - Includes 2 Swivel Wheels with Brakes and 2 Fixed Wheels





## Light Duty Mesh Cage Trolley (With Steel Shelves)

- Powder coated finish
- Key lockable
- Comes with 3 steel shelves plus the base shelf
- Shelf Heights: 630mm, 1040mm and 1450mm
- Load Capacity with standard wheels: 500kg (125kg per shelf, evenly distributed)
- Load Capacity with pneumatic wheels: 200kg
- Mesh Size: 50x50mm
- Rubber castors - 2x fixed, 2x swivel with brakes
- Optional flat free wheel kit - includes 2 Swivel wheels with brakes and 2 fixed wheels



Lockable to secure contents

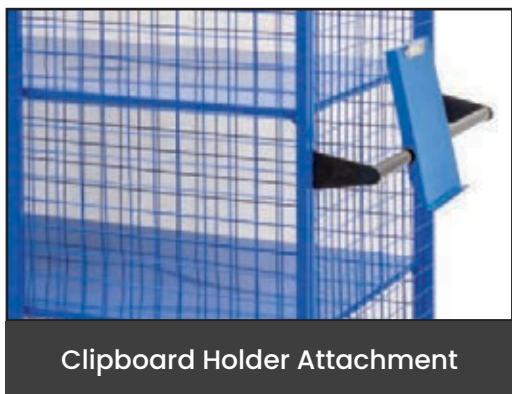

Clipboard Holder Attachment



Flat Free Wheel Kit (Includes 2 Swivel Wheels with Brakes and 2 Fixed Wheels)



Code	Details	Base Height (mm)	Castors (mm)	Handle Height (mm)	Shelf Size (mm)	Overall Size LxWxH (mm)	Unit Weight (kg)
V1145	Mesh Cage Trolley	280	200	950	1170x730	1300x750x1790	55
V1845	Flat Free Wheel Kit - Includes 2 Swivel Wheels with Brakes and 2 Fixed Wheels						
V1841	Clipboard Holder Attachment to suit V1145						



# Heavy Duty Sloping 4 Shelf Trolleys

- Heavy duty bolt together trolley which is great for stock picking
- 4 backwards sloping shelves which prevents items falling off
- Shelves are removable but not adjustable
- Shelves have 10° decline
- 350mm space between each shelf
- Push/pull handles on each end
- Rubber castors: 2 fixed, 2 swivel with brakes
- Load Capacity with pneumatic wheels: 200kg



V1845 Flat Free Wheel Kit



Shelves are reinforced underneath for extra strength



V1080



V1081

Code	Details	Load Capacity (kg)	Castors (mm)	Shelf Size (mm)	Overall Size LxWxH (mm)	Unit Weight (kg)
V1080	Sloping Shelf Trolley - 1410mm wide	500	150	1160x580	1410x620x1770	94
V1081	Sloping Shelf Trolley - 1730mm wide	500	150	1460x730	1730x770x1770	122
V1845	Pneumatic Wheel Kit to suit V1080 & V1081					



## Heavy Duty 3 Sided Mesh Cage Trolley

- These cage trolleys are an ideal trolley for stock packing and goods movement
- The base folds up for compact storage
- Optional heavy duty removable shelves
- Flat free wheel kit available to suit (pictured)
- These trolleys come with a removable front bar
- Comes with signboard area on the side
- Rubber castors- 2 x swivel, 2 x swivel with brakes
- Powder coated finish
- Base Height: 200mm
- Shelf can be positioned on mesh with 60mm increment
- Shelf Size: 1020x750mm



Code	Castors (mm)	Load Capacity (kg)	Shelf Capacity (kg)	Overall Size LxWxH (mm)	Unit Weight (kg)
V1900	125	500	125	1100x850x1700	50

## Heavy Duty Mesh Cage Trolley

- These cage trolleys are an ideal trolley for stock packing and goods movement
- The base folds up for compact storage
- Optional heavy duty removable shelves available
- Flat free wheel kit available to suit
- These trolleys come with a removable front bar
- Comes with signboard area on the side
- Rubber castors- 2 x swivel, 2 x swivel with brakes
- Powder coated finish
- Base Height: 200mm
- Shelf can be positioned on mesh with 60mm increment
- Shelf Size: 1020x750mm



Code	Castors (mm)	Load Capacity (kg)	Shelf Capacity (kg)	Overall Size LxWxH (mm)	Unit Weight (kg)
V1904	125	500	125	1100x850x1700	62





## Heavy Duty Mesh Cage Trolley (with Roof)

- These cage trolleys are an ideal trolley for stock packing and goods movement
- The base folds up for compact storage
- Roof for fully securing contents of cage
- Optional heavy duty removable shelves
- Flat free wheel kit available to suit
- These trolleys come with a removable front bar
- Comes with signboard area on the side
- Rubber castors- 2 x swivel, 2 x swivel with brakes
- Powder coated finish
- Base Height: 200mm
- Shelf can be positioned on mesh with 60mm increment
- Shelf Size: 1020x750mm



Code	Castors (mm)	Load Capacity (kg)	Shelf Capacity (kg)	Overall Size LxWxH (mm)	Unit Weight (kg)
V1905	125	500	125	1100x850x1700	71

## Accessories to suit Heavy Duty Mesh Cage Trolleys



V1845 - Flat Free Wheel Kit



V1901 - Optional Shelves



V1841Z - Optional Clipboard



V1905 with 2 x V1901 &amp; V1845

Code	Details
V1901	Optional Shelves to suit Mesh Cage Trolleys
V1845	Flat Free Wheel Kit - Includes 2 Swivel Wheels with Brakes and 2 Fixed Wheels
V1841Z	Optional Clipboard Holder Attachment to suit Mesh Cage Trolleys

## Garment Transport Trolley

- Ideal for stock packing, goods and product movement and general use.
- Garment rail for transporting hanging goods
- Can be used for retail, in offices, warehouses and many other applications!
- Bolt together construction
- Zinc plated finish
- Rubber Castors - 2 x swivel, 2 x swivel with brakes
- Handle Height: 1065mm
- Base Height: 223mm



Code	Castors (mm)	Load Capacity (kg)	Overall Size LxWxH (mm)	Internal Size LxWxH (mm)	Unit Weight (kg)
V1910	125	350	1472x680x1710	1305x675x1476	35

## Open Front Cage Trolley

- Ideal for stock packing, goods movement and more.
- Garment rail for transporting hanging goods
- Removable back panel (supplied as 3 panels)
- Multiple accessories available - see page 88
- Able to fit up to 6 shelves at 200mm pitch
- Bolt together construction
- Zinc plated finish
- Rubber Castors - 2 x swivel, 2 x swivel with brakes
- Handle Height: 1065mm
- Base Height: 223mm



Code	Castors (mm)	Load Capacity (kg)	Overall Size LxWxH (mm)	Internal Size LxWxH (mm)	Unit Weight (kg)
V1930	125	350	1472x687x1710	1305x675x1476	47





# Fully Lockable Cage Trolley with Doors & Roof

- Ideal for stock packing, goods movement and more.
- Roof and doors for securing goods during transport
- Removable back panel (supplied as 3 panels)
- Multiple accessories available - see page 88
- Able to fit up to 6 shelves at 200mm pitch
- Bolt together construction
- Zinc plated finish
- Rubber Castors - 2 x swivel, 2 x swivel with brakes
- Internal Size (LxWxH): 1305x675x1476mm
- Handle Height: 1065mm
- Base Height: 223mm

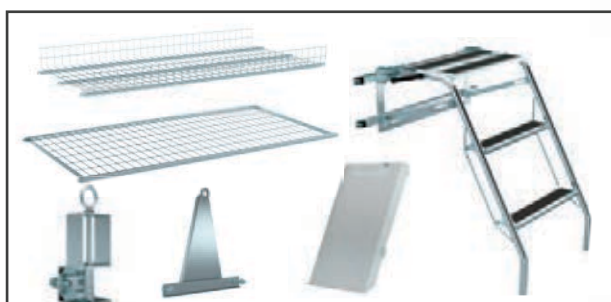

See accessories to suit on page 88



Code	Castors (mm)	Load Capacity (kg)	Overall Size LxWxH (mm)	Unit Weight (kg)
V1931	125	350	1472x745x1710	72





## Cage Trolley with 3 Mesh Tray Shelves

- Ideal for stock packing, goods movement and more.
- Supplied with 3 tray mesh shelves (V1913) - centre shelf is adjustable
- Multiple accessories available - see page 88
- Zinc plated finish
- Rubber Castors - 2 x swivel, 2 x swivel with brakes
- Handle Height: 1065mm
- Base Height: 223mm

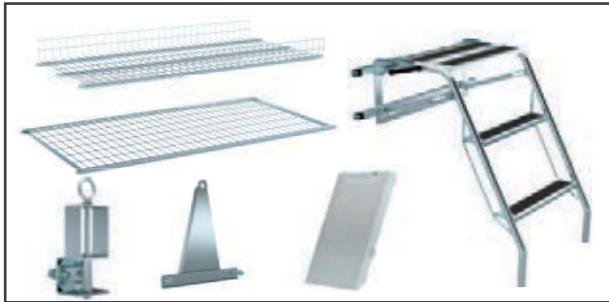

See accessories to suit on page 88

Code	Castors (mm)	Load Capacity (kg)	Overall Size LxWxH (mm)	Internal Size LxWxH (mm)	Unit Weight (kg)
V1932	125	350	1472x687x1710	1305x675x1476	58

## Cage Trolley with 3 Sloping Shelves

- Ideal for stock packing, goods movement and more.
- Roof and doors for securing goods during transport
- Removable back panel (supplied as 3 panels)
- Multiple accessories available - see page 88
- Able to fit up to 6 shelves at 200mm pitch
- Bolt together construction
- Zinc plated finish
- Rubber Castors - 2 x swivel, 2 x swivel with brakes
- Handle Height: 1065mm
- Base Height: 223mm



See accessories to suit on page 88

Code	Castors (mm)	Load Capacity (kg)	Overall Size LxWxH (mm)	Internal Size LxWxH (mm)	Unit Weight (kg)
V1933	125	350	1472x687x1710	1305x675x1476	87



## Cage Trolley with Basket

- Ideal for stock packing, goods movement and more.
- Garment rail for transporting hanging goods
- Lower basket to stop boxes falling off in transport
- Multiple accessories available - see page 88
- Able to fit up to 4 shelves (V1912, V1913, V1914) at 200mm pitch
- Bolt together construction
- Zinc plated finish
- Rubber Castors - 2 x swivel, 2 x swivel with brakes
- Handle Height: 1065mm
- Base Height: 223mm



Code	Castors (mm)	Load Capacity (kg)	Overall Size LxWxH (mm)	Internal Size LxWxH (mm)	Unit Weight (kg)
V1934	125	350	1472x700x1710	1305x675x1476	43

## Packaging Trolley

- Zinc plated Trolley with an adjustable top shelf and dividers is best suited to transport cartons and various packaging materials
- Bolt together construction
- Rubber Castors - 2 x swivel, 2 x swivel with brakes
- Castors: 125mm
- Distance Between Level/Shelves 947mm (as Pictured)
- \*Adjustable top shelf at 200mm increment
- Distance Between Dividers +- 430mm (as Pictured)
- \*Adjustable Divider at 40mm increment along the shelf



Designed to maximise packaging production with adjustable compartments to suit your specific workplace needs



View video of this in operation here:  
[www.verdex.com.au/v1941](http://www.verdex.com.au/v1941)



Code	Load Capacity (kg)	Overall Size LxWxH (mm)	Handle Height (mm)	Base Height (mm)	Unit Weight (kg)
V1941	350	1472x680x1710	1065	223	49



## Accessories to suit 1910 Trolleys

- Range of accessories available, to suit cage trolleys on pages 84-87



V1912 - Flat Mesh Shelf



V1913 - Tray Mesh Shelf



V1914 - Reversible Solid/Tray Shelf



V1915 - Sloping Shelf Bracket



V1916 - Fork Pockets



V1917 - Centre Wheel Kit



V1918 - Shelf Divider



V1920 - Trolley Towing Set



V1921 - Retractable Ladder



V1922 - Handles to suit Ladder

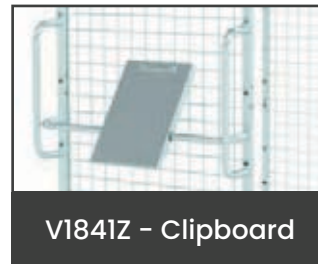

V1841Z - Clipboard



V1840Z - Drink Holder



V1848Z - A4 Pocket

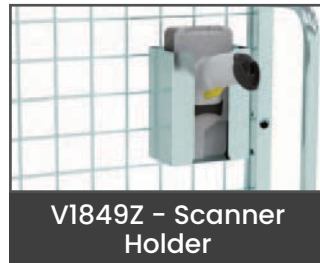

V1849Z - Scanner Holder

See video of 1910 Cage Trolleys and accessories to suit



View video of this in operation here [www.verdex.com.au/V1930](http://www.verdex.com.au/V1930)



Code	Details	V1930	V1931	V1932	V1933	V1934
V1912	Flat Mesh Shelf	Y	Y	-	-	Y
V1913	Tray Mesh Shelf	Y	Y	Y	-	Y
V1914	Reversible Solid/Tray Shelf	Y	Y	-	Y	Y
V1915	Sloping Shelf Bracket to suit V1912 & V1914 Shelves	Y	Y	-	Y	Y
V1916	Fork Pockets	Y	Y	Y	Y	Y
V1917	Centre Wheel Kit	Y	Y	Y	Y	Y
V1918	Shelf Divider to suit Mesh Shelves (V1912 & V1913)	Y	Y	Y	-	Y
V1920	Trolley Towing Set	Y	Y	Y	Y	Y
V1921	Retractable Ladder	Y	Y	Y	Y	Y
V1922	Handles to suit Retractable Ladder (V1921)	Y	Y	Y	Y	Y
V1840Z	Drink Holder	Y	Y	Y	Y	Y
V1841Z	Clipboard Writing Panel	Y	Y	Y	Y	Y
V1848Z	A4 Pocket	Y	Y	Y	Y	Y
V1849Z	Scanner Holder	Y	Y	Y	Y	Y





# BUILD YOUR OWN CAGE TROLLEY USING OUR ONLINE CONFIGURATOR

## 1910 SERIES TROLLEY CONFIGURATOR

Make your own trolley!

Pick the parts and see the final product in the preview

Quantity

- 1 +

Subtotal  
\$760

Grand Total  
\$760

GST Toggle  
 Off

Start Over

Share

**i** This configurator doesn't give you all possible options. Call our support team for more details.

### TROLLEY VARIANT

<b>\$760.00</b> Basic Trolley M1910	<b>\$890.00</b> Open Front Cage Trolley M1930	<b>\$890.00</b> Cage Trolley with Basket M1934	<b>\$1,350.00</b> Fully Lockable Cage Trolley with Doors and Roof M1931
<b>Selected</b>	Select	Select	Select

### SHELVES

<b>\$288.00</b>	<b>\$149.00</b>	<b>\$195.00</b>	<b>\$308.00</b>

Select the options to build your specific Cage Trolley!



CAGE TROLLEY  
Initial vs. Full Kit  
Configuration



Scan here for our online Configurator Page

[www.verdex.com.au/configurator](http://www.verdex.com.au/configurator)

## Steerable Load Skates

- The steerable skate can be used to move heavy objects up to 12000kg
- The rubber padded platform swivels on a thrust bearing allowing easy movement around corners
- V1330 & V1335 have nylon roller wheels
- V1340 has steel roller wheels



Code	Details	Load Capacity (kg)	Castors Dia. (mm)	Castors Width (mm)	Pad Size (mm)	Base Size LxWxH (mm)	Unit Weight (kg)
V1330	Steerable Load Skate	3000	85	90	180x150	230x185x105	15
V1335	Steerable Load Skate	6000	85	90	400x220	550x590x120	45
V1340	Steerable Load Skate	12,000	80	85	400x220	560x585x120	66

## Equipment Roller Skates

- Ideal for linear motion, repetitive movement or use as a built in component in equipment
- Fixed hole pattern for bolt mounting
- The rollers can be used in up down or sideways position

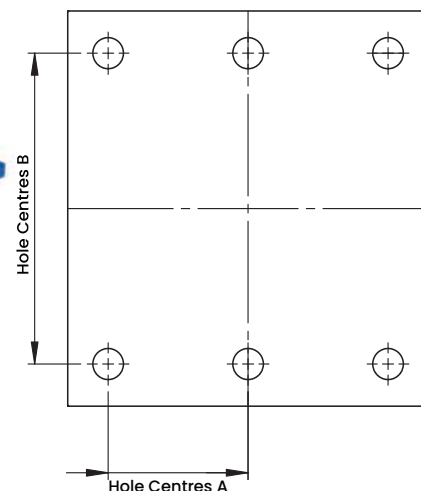

Code	Details	Load Capacity (kg)	Hole Centres A (mm)	Hole Centres B (mm)	Overall Size LxWxH (mm)	Unit Weight (kg)
V1350	Roller Skates	750	64	140	165x178x80	5
V1355	Roller Skates	2500	64	140	165x180x90	10
V1360	Roller Skates	5000	83	171	203x203x80	15
V1365	Roller Skates	15,000	94	216	270x254x100	21



## Roller Load Skates

- These skates are designed to move heavy loads e.g machinery and heavy workshop equipment up to 10 tonnes.
- Available with diamond steel top or rubber pad top which protects items from scratching.
- Optional steering handle available
- Turntable is lockable
- Number of Rollers: 14
- Handle Length: 1310mm
- Rotating Top Diameter: 145mm



V1300



V1301



V1302



Code	Details	Load Capacity (kg)	Overall Size LxWxH (mm)	Unit Weight (kg)
V1300	Roller Load Skate - Diamond Steel Top	10,000	270x150x135	17
V1301	Roller Load Skate - Rubber Pad Top	10,000	270x150x125	17
V1302	Steering Handle to Suit V1300 & V1301			7

## Load Shifting Skates 2.5 Tonne & 6 Tonne Capacity

- These shifting skates can be used wherever heavy objects need to be moved
- Large diameter nylon rollers ensure ease of movement and spread the load to protect floors from damage caused from high load points
- Fitted with a rubber surface to protect the objects being moved



V1310

V1315



Code	Details	Load Capacity (kg)	Castors (mm)	Overall Size LxWxH (mm)	Unit Weight (kg)
V1310	Shifting Skates (2 x Rollers)	2,500	2 x 85	210x100x105	4
V1315	Shifting Skates (6 x Rollers)	6,000	6 x 85	412x210x105	12





## Pegboard Tool Trolley

- Great tool trolley for general workshop use
- Comes with metal pegboard on back as well as the sides which can be used to hold tools and equipment
- Powder coated light grey finish
- 75mm rubber castors - 2 x fixed, 2 x swivel with brakes



Code	Load Capacity (kg)	Handle Height (mm)	Shelf Heights (mm)	Shelf Size (mm)	Back Panel Size (mm)	Overall Size LxWxH (mm)	Unit Weight (kg)
V7225	250	825	160 + 510 + 900	595x405	605x440	670x415x1730	43.5

## Industrial Tooling Cabinet on Wheels

- Heavy duty tooling cabinets are ideal for industrial applications and workshops
- The sliding drawers are a welded strengthened single rail design coupled with high quality mechanical bearings for long lasting smooth operation
- Each drawer is rated at 100kg load capacity with 97% access
- Single key lock design for safe storage. Each drawer has a mechanical safety lock which allows one drawer to be opened at a time, preventing the cabinet from tipping over
- Rubber castors - 2 x fixed, 2 x swivel with brakes
- All drawers come with adjustable steel dividers
- 6 Drawers:
  - 2 Drawers x 75mm
  - 2 Drawers x 100mm
  - 2 Drawers x 150mm



Code	Load Capacity (kg)	Castors (mm)	Overall Size LxWxH (mm)	Unit Weight (kg)
V7215	500	125	565x580x900	76



# Parts Bin Trolley

- PVC mat on top and bottom tray
- Transparent front window on the parts bin
- Each bin comes with one divider and one bin label card
- Parts trays have a raised back lip
- Plastic Parts Bin size (LxWxH): 450x165x105mm
- 265mm distance between bottom and middle shelf on V7226 model
- Load capacity: 400kg
- Rubber castors - 2 x fixed, 2 x swivel with brakes



V7226



V7227

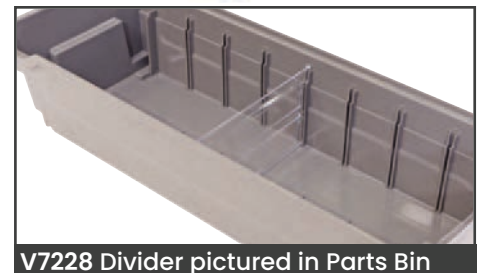
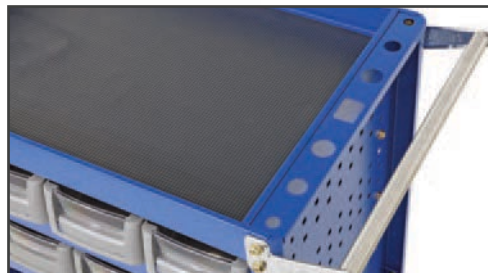

V7228 Divider pictured in Parts Bin

Code	Details	Castors (mm)	Distance Between Shelves (mm)	Shelf Size (mm)	Overall Size LxWxH (mm)	Unit Weight (kg)
V7226	Parts Bin Trolley (8 parts bins)	100	110	755x465	850x500x855	34
V7227	Parts Bin Trolley (16 parts bins)	100	110	755x465	850x500x855	38
V7228	Optional Divider for Parts Bins (available separately to parts bin)					

You May Also Like



See page 61



See pages 16-17



See page 60





## Mobile Panel Cart with Storage Cabinet

- The Panel Cart is used for transporting and storing a range of products
- The Mobile Panel Cart features 3 storage shelves as well as a large base which provides easy storage & accessibility for a range of products
- Pegboard Size (WxH): 850x300mm
- Louvre and pegboard panels are compatible with our Stor-Pak and pegboard accessories
- Storage cabinet supplied with a lock
- Powder coated dark grey finish
- Rubber castors - 2 x swive & 2 x swivel with brakes



Code	Castors (mm)	Shelf Capacity (kg)	Shelf Size (mm)	Cupboard Internal Size WxDxH (mm)	Overall Size LxWxH (mm)	Unit Weight (kg)
V7275	125	50	870x150	865x220x430	1025x670x1420	65

**You  
May  
Also  
Like**



**Wheel Chock Trolley**  
See page 303





## Louvre & Pegboard Panel Trolleys

- Strong metal panel trolleys which are ideal for storing either Stor-Pak Bins or tools on hooks
- Fitted with 4 swivel castors (2 with brakes)
- Powder coated grey colour
- Can be ordered one side with louvre panel and one side with square hole metal pegboard with code V7270
- Wheels can be removed to make fixed shelving if required
- Stor-Pak Bins and panel hooks are sold separately



**V7260K - Louvre Panel Trolley Kit**  
(with Stor-Pak Bins as listed below)

- 16 x No. 5 Stor-Pak Bins (Blue)
- 16 x No. 5 Stor-Pak Bins (Yellow)
- 16 x No. 10 Stor-Pak Bins (Red)
- 16 x No. 10 Stor-Pak Bins (Green)
- 12 x No. 25 Stor-Pak Bins (Yellow)
- 8 x No. 60 Stor-Pak Bins (Blue)
- 8 x No. 60 Stor-Pak Bins (Red)
- 4 x No. 120 Stor-Pak Bins (Green)

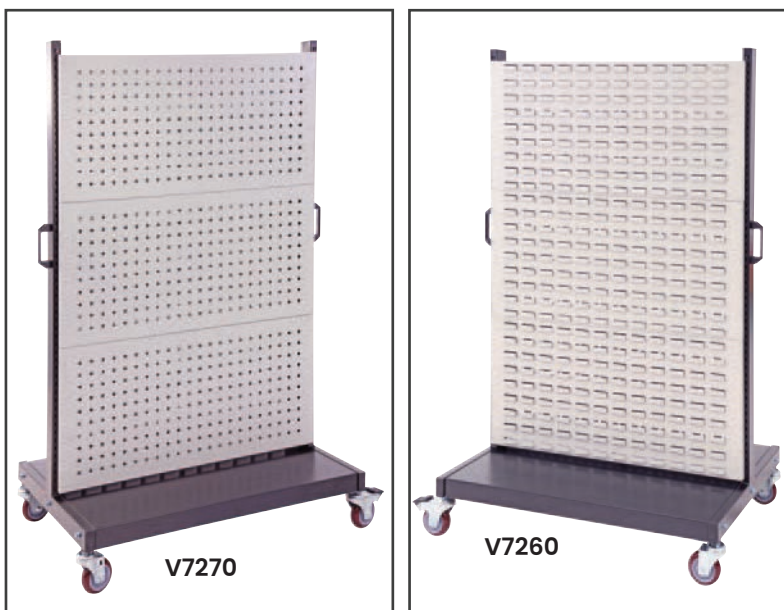

**V7270**

**V7260**



**V7265 - Shelf to suit panel trolley**

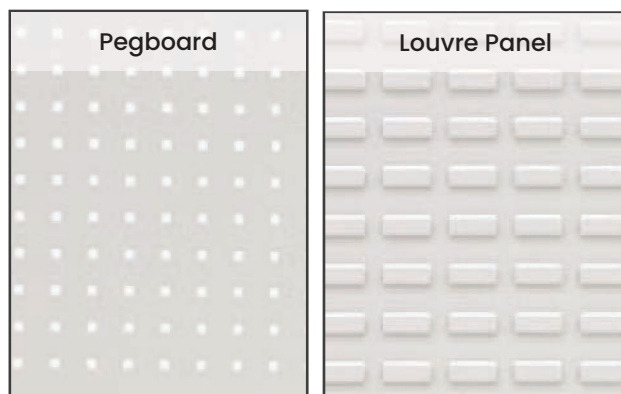

**Pegboard**

**Louvre Panel**

Code	Details	Overall Size LxWxH (mm)	Unit Weight (kg)
V7260	Louvre Panel Trolley	1040x980x1540	60
V7270	Panel Trolley (1 side pegboard & 1 side louvre panel)	1040x980x1540	60
V7262	Square Pegboard Panel Trolley	1040x980x1540	60
V7260K	Louvre Panel Trolley Kit*	1040x980x1540	85
V7265	Shelf to suit Panel Trolley	940x220	3

\*With Stor-Pak Bins exactly as pictured above

## Industrial Tooling Workstation

- Heavy duty tooling cabinets for industrial workshop applications
- The sliding drawers have quality smooth operation bearings
- Lockable cupboard with adjustable shelf
- Finish: Powder coated light grey and blue
- 2 fixed castors and 2 swivel lockable castors
- Fixed metal pegboard panel which suits our range of hooks and accessories
- Rubber mat on workbench area
- 5 lockable drawers with dividers (3 x 100mm and 2 x 200mm drawers)
- Bench Height: 950mm



Pictured with V7207 & V7208



Code	Details	Individual Drawer Capacity (kg)	Overall Capacity (kg)	Overall Size LxWxH (mm)	Unit Weight (kg)
V7230	Industrial Tooling Workstation	100	500	1100x580x1450	115
V7206	Extra Divider to suit 100mm Drawers				
V7207	Extra Divider to suit 200mm Drawers				

## Industrial Cabinet with 2 Drawers

- Storage cabinet is ideal for workshop and industrial applications
- Pegboard, drawer and cupboard storage spaces guarantee various sized tools and equipment can be stored efficiently
- Metal pegboard to neatly arrange tools and equipment for easy access
- Sliding drawers with smooth operation bearings allow smaller parts to be organised. Drawers also have adjustable dividers.
- 2 door lockable cabinet with 1 adjustable shelf
- Pegboard Size: 870x500mm

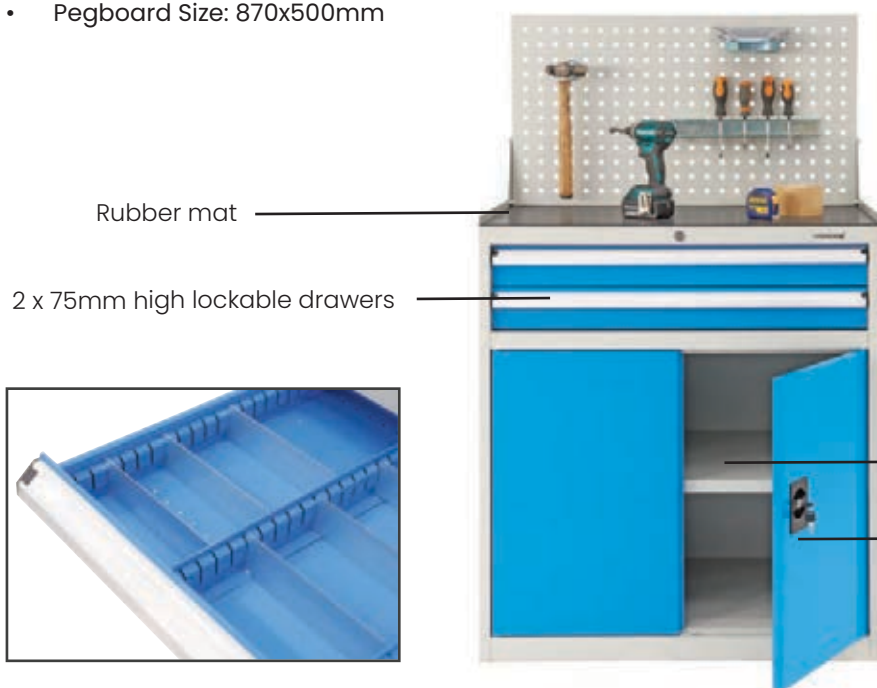

Adjustable shelves

Lockable cabinet

Code	Load Capacity (kg)	Shelf Capacity (kg)	Drawer Capacity (kg)	Bench Height (mm)	Bench Size (mm)	Overall Size WxDxH (mm)	Unit Weight (kg)
V7211	600	100	75	1010	875x555	900x585x1515	97.5





## 7 Drawer Industrial Tooling Cabinet

- The sliding drawers are a welded strengthened single rail design coupled with high quality mechanical bearings for long lasting smooth operation
- Each drawer has a mechanical safety lock which allows one drawer to be opened at a time
- All drawers come with adjustable steel dividers
- Drawer 1 to 6 - 150mm high
- Drawer 7 - 200mm high
- Internal Size (WxDxH): 777x451x122 (Drawers 1-6)
- Internal Size (WxDxH): 777x451x122 (Drawer 7)



Pictured with V7207 &amp; V7208



Code	Details	Individual Drawer Capacity (kg)	Overall Size WxDxH (mm)	Unit Weight (kg)
V7220	7 Drawer Industrial Tooling Cabinet	100	881x653x1200	121
V7207	Extra Divider to suit 200mm Drawers			
V7208	Extra Divider to suit 150mm Drawers			

## 10 Drawer Industrial Tooling Cabinet

- Heavy duty tooling cabinets for industrial applications
- The sliding drawers are a welded strengthened single rail design coupled with high quality mechanical bearings for long lasting smooth operation
- Single key lock design for safe storage.
- Each drawer has a mechanical safety lock which allows one drawer to be opened at a time, preventing the cabinet from tipping over
- All drawers come with adjustable steel dividers
- Drawer 1 to 9 - 100mm high
- Drawer 10 - 200mm high



Pictured with V7207 &amp; V7208



Code	Details	Individual Drawer Capacity (kg)	Overall Size WxDxH (mm)	Unit Weight (kg)
V7221	10 Drawer Industrial Tooling Cabinet	100	881x653x1200	160
V7206	Extra Divider to suit 100mm Drawers			
V7207	Extra Divider to suit 200mm Drawers			





# Heavy Duty Industrial Storage Cabinets

- These heavy duty industrial storage cabinets are made from reinforced sheet metal and are great for storing tools, parts and many other items in the workplace
- Full height cabinets come standard with 4 adjustable shelves and 1/2 height cabinet comes standard with 2 adjustable shelves – extra shelves can be purchased if required
- Optional drawer units can be purchased in either 100mm or 200mm deep
- Drawers come standard with 15 compartments (4 slotted partitions & 10 dividers)
- Total Cabinet Load Capacity: 600kg
- Shelf Capacity: 100kg
- Finish: Powder coated light grey with light blue coloured doors/drawers
- V7205 Cabinet Base Stand is ideal for levelling the cabinets on uneven floors (suits V7201 only)



## 1/2 Height Cabinet

- Shelf Capacity: 100kgs
- 3 point key lock system
- 2 adjustable shelves as standard
- Option drawer units available which fit inside unit so doors can be locked

**Code: V7200**



**V7209 Divider**  
to suit V7200  
& V7201 1/2 &  
Full Height  
Cabinets



**Code: V7205**  
Cabinet base stand available to suit V7201



## Full Height Cabinet

- Shelf Capacity: 100kgs
- 3 point key lock system
- 4 adjustable shelves as standard
- Optional drawer units available which fit inside unit so doors can be locked

**Code: V7201**





Optional drawer units available



Doors can be removed if preferred



100mm drawer

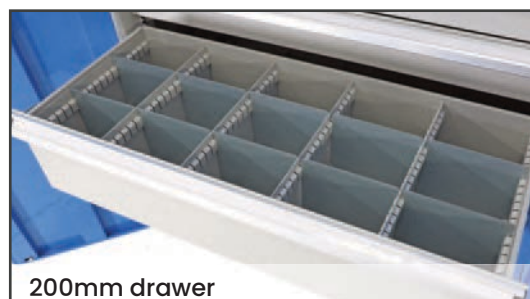

200mm drawer

Code	Details	Capacity (kg)	Overall Size WxDxH (mm)	Unit Weight (kg)
V7200	1/2 Height Industrial Cabinet	100 per shelf	900x450x900	45
V7201	Full Height Industrial Cabinet	100 per shelf	900x450x1800	85
V7202	Small Drawer Unit (to suit cabinets)	50 per drawer	100mm deep	8
V7203	Large Drawer Unit (to suit cabinets)	75 per drawer	200mm deep	15
V7204	Extra Shelves to suit Cabinets	150	840x380x30	5
V7205	Cabinet Base Stand (suits V7201) raises cabinet 70mm			4
V7206	100mm Divider to suit V7202 & V7203 (Pack of 10)	-	-	-
V7207	200mm Divider to suit V7202 & V7203 (Pack of 10)	-	-	-
V7209	Divider to suit V7200 & V7201	-	385x60x330	1.5

## Industrial Tooling Drawer Unit

- These industrial tooling drawers are a heavy duty drawer cabinet for industrial applications
- The 1/2 height industrial cabinet can be mounted on top of the tooling cabinet (as per image shown below)
- Finish: Powder coated light grey with light blue coloured drawers
- 2 x 100mm deep drawers
- 3 x 200mm deep drawers
- Drawers have adjustable dividers



V7210 - Drawer Unit

Pictured is the V7210 on the bottom with V7200 mounted on top



Code	Drawer Capacity (kg)	Overall Size WxDxH (mm)	Unit Weight (kg)
V7210	75	900x450x900	99

# Heavy Duty Industrial Storage Cabinets Complete With Drawers

- These heavy duty industrial storage cabinets are made from reinforced sheet metal and are great for storing tools, parts and many other items in the workplace
- Finish: Powder coated light grey with light blue coloured doors
- Supplied with 4 adjustable shelves
- Drawers come standard with 15 compartments (4 slotted partitions & 10 dividers)
- Overall Size (HxWxD): 1800x900x450mm
- Total Cabinet Load Capacity: 600kg
- 100mm Drawer Capacity: 50kg
- 200mm Drawer Capacity: 75kg
- Shelf Capacity: 100kg

### V8150 - 2 Drawer Cabinet

- 1 x 100mm drawer & 1 x 200mm drawer

### V8151 - 4 Drawer Cabinet

- 2 x 100mm drawers & 2 x 200mm drawers

### V8152 - 6 Drawer Cabinet

- 3 x 100mm drawers & 3 x 200mm drawers

### V8160 - 8 Drawer Cabinet

- 8 x 100mm drawers

### V8162 - 10 Drawer Cabinet

- 10 x 100mm drawers

### V8170 - 7 Drawer Cabinet

- 2 x 100mm drawers & 5 x 200mm drawers

### V8171 - 6 Drawer Cabinet

- 5 x 100mm drawers & 1 x 200mm drawer

### V8172 - 8 Drawer Cabinet

- 5 x 100mm drawers & 3 x 200mm drawers

### V8175 - 5 Drawer Cabinet

- 5 x 200mm drawers



100mm drawer



200mm drawer



Doors can be removed if preferred

Code	Details	Unit Weight (kg)
V8150	2 Drawer Cabinet ( 1 x 100mm & 1 x 200mm drawers)	108
V8151	4 Drawer Cabinet ( 2 x 100mm & 2 x 200mm drawers)	131
V8152	6 Drawer Cabinet ( 3 x 100mm & 3 x 200mm drawers)	154
V8160	8 Drawer Cabinet ( 8 x 100mm drawers)	149
V8162	10 Drawer Cabinet ( 10 x 100mm drawers)	165
V8170	7 Drawer Cabinet ( 2 x 100mm & 5 x 200mm drawers)	176
V8171	6 Drawer Cabinet ( 5 x 100mm & 1 x 200mm drawers)	140
V8172	8 Drawer Cabinet ( 5 x 100mm & 3 x 200mm drawers)	170
V8175	5 Drawer Cabinet ( 5 x 200mm drawers)	160





V8150  
(1 x 100mm & 1 x 200mm drawers)



V8151  
(2 x 100mm & 2 x 200mm drawers)



V8152  
(3 x 100mm & 3 x 200mm drawers)



V8160  
(8 x 100mm drawers)



V8162  
(10 x 100mm drawers)



V8170  
(2 x 100mm & 5 x 200mm drawers)



V8171  
(5 x 100mm & 1 x 200mm drawers)



V8172  
(5 x 100mm & 3 x 200mm drawers)



V8175  
(5 x 200mm drawers)



## Industrial & Cleanroom Seating

- This seating is designed to withstand hard use, moisture and chemicals in the industrial environment
- Ideal for workplace environments such as factory production lines, clean rooms, workshops and laboratories
- Easy clean polyurethane or industrial vinyl seats and backrests
- Easy clean polyurethane or industrial vinyl seats and backrests
- Chairs are available with glide feet or standard castors
- Load Capacity: 110kg



Nylon Glides & Castors



C1204C pictured with V7300K



C1200



C1201



C1202



C1203



C1204

Code	Details	Height Adjustment (mm)	Unit Weight (kg)
C1200C	Polyurethane Saddle Seat (with Castors)	420 - 520	10
C1200G	Polyurethane Saddle Seat (with Glides)	420 - 620	10
C1201C	Polyurethane Stool - foot rest surround (with Castors)	590 - 840	10
C1201G	Polyurethane Stool - foot rest surround (with Glides)	590 - 840	10
C1202C	Polyurethane Chair (with Castors)	460 - 660	10
C1202G	Polyurethane Chair (with Glides)	460 - 660	10
C1203C	Polyurethane Round Seat - foot rest surround (with Castors)	590 - 840	10
C1203G	Polyurethane Round Seat - foot rest surround (with Glides)	590 - 840	10
C1204C	Polyurethane Round Seat (with Castors)	420 - 520	10
C1204G	Polyurethane Round Seat (with Glides)	420 - 520	10





## Ergo Tred Anti-Fatigue Matting

Ergo Tred is a hardwearing, comfortable, non-slip anti-fatigue mat. It is used in dry, demanding work areas such as at checkouts, counters, machines, workbenches and workstations.

- Extremely comfortable – provides relief from constant standing
- Domed surface is ergonomically designed to improve circulation in feet and legs
- Hard wearing – long mat life even in demanding conditions
- Yellow border option – makes mat edges stand out to warn user of hazard
- HACCP Certified for use in dry areas



Black with Yellow border

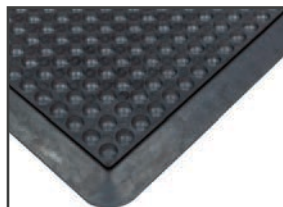

Black with Black border



Code	Details	Colour	Overall Size (mm)
V7730	Ergo Tred Rubber Anti-Fatigue Mat	Black	600x900
V7731	Ergo Tred Rubber Anti-Fatigue Mat	Black & Yellow	600x900
V7732	Ergo Tred Rubber Anti-Fatigue Mat	Black	900x1200
V7733	Ergo Tred Rubber Anti-Fatigue Mat	Black & Yellow	900x1200

## Anti-fatigue Safety Cushion Matting

- Popular general purpose safety mat
- Comfort non-slip mat
- Bevelled edges for safety
- Optional grease resistant formula
- Ideal for factories, kitchens, food preparation areas, boats and behind counters



General Purpose



Grease Resistant

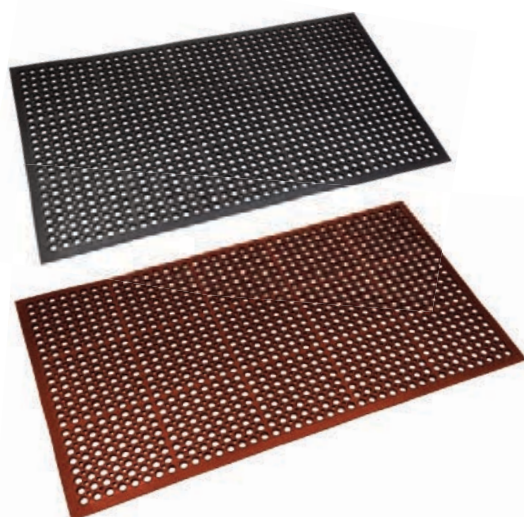

Code	Details	Type	Overall Size (mm)	Unit Weight (kg)
V7720	Anti-fatigue Safety Cushion Mat	General Purpose	600x900mm	6
V7721	Anti-fatigue Safety Cushion Mat	General Purpose	900x1500mm	10
V7722	Anti-fatigue Safety Cushion Mat	Grease Resistant	600x900mm	6
V7723	Anti-fatigue Safety Cushion Mat	Grease Resistant	900x1500mm	10





## Heavy Duty Warehouse Packing Bench

- Strong heavy duty work or packing bench
- 25mm MDF bench top and shelf
- Bench is supplied flat packed
- Image shown with optional bottom shelf
- Castor Kit raises bench height by 140mm
- Top and bottom shelves are height adjustable
- Bench Size: 2390x860x25mm

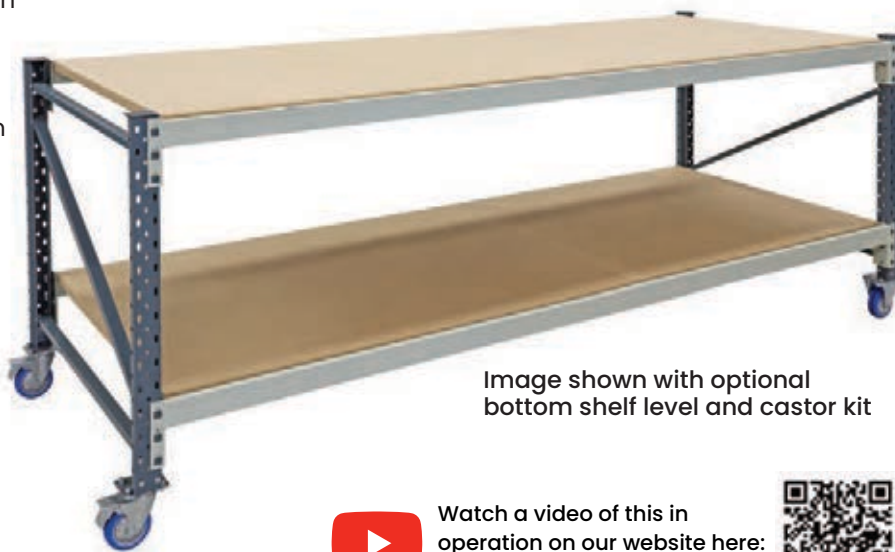

Image shown with optional bottom shelf level and castor kit



Timber shelf is chamfered to remove sharp edge



Watch a video of this in operation on our website here: [www.verdex.com.au/v7320](http://www.verdex.com.au/v7320)



Code	Details	Load Capacity(kg)	Overall Size LxWxH (mm)	Unit Weight (kg)
V7320	Heavy Duty Packing Bench	500	2525x900x1000	74
V7321	Optional Bottom Shelf	-	2390x860x25	36
V7326	100mm Lockable Castor Kit to suit Packing Bench			8

## Heavy Duty Industrial Workbenches 900 Series

- Heavy duty steel industrial workbench is ideal for use as a work or tool bench
- This workbench has a 600kg top bench capacity
- 28mm thick laminated wooden top
- Comes standard with adjustable feet for levelling on uneven floors
- Finish: Powder coated light grey



V7246 Lockable Castor Kit



V7300 - Workbench



Dividers supplied with drawer unit



Code	Details	Dimensions LxWxH (mm)	Unit Weight (kg)
V7300	Industrial Workbench	900x750x800	35
V7310	Lockable Drawer Unit 410x680x180mm (WxDxH)	410x680x180	12
V7246	Castor Kit to suit V7300 Workbench		





# Heavy Duty Industrial Workbenches 1200 Series

- Heavy duty steel industrial workbench with bottom shelf is ideal for use as a work or tool bench
- 1000kg wood top bench capacity
- 53mm thick laminated wooden top
- Comes standard with adjustable feet for levelling on uneven floors and an optional lockable castor kit is available if required
- Drawer Unit Capacity: 100kg per drawer
- Finish: Powder coated light grey



**V7246**  
Lockable Castor Kit

## Shelf Options

**V7253 - 2 Tier Shelf**



**V7250 - Adjustable Shelf**



## Drawer & Cabinet Options



**V7244 - 2 Drawer Unit**  
2 x 100mm drawers



**V7312 - 3 Drawer Unit**  
2 x 100mm, 1 x 200mm drawers



**V7315 - Cabinet Unit**

Code	Details	Dimensions (mm)	Unit Weight (kg)
V7305	Industrial Workbench	1200x750x900 (LxWxH)	66
V7312	Lockable Drawer Unit (3 drawer)	565x650x450mm (WxDxH)	45
V7315	Lockable Cabinet Unit (with shelf)	565x650x450mm (WxDxH)	14
V7250	Adjustable Shelf to suit V7305	1200x285mm (LxD)	9
V7253	2 Tier Shelf Unit to suit V7305	1200x250mm (LxD)	13
V7244	Lockable Drawer Unit (2 drawer)	565x650x280mm (WxDxH)	25.5
V7246	Workbench Castor Kit (includes 4 swivel castors with brakes)		



# Heavy Duty Industrial Work Benches 1800/2100 Series

- Heavy duty steel industrial workbenches which are ideal for use as a work or tool benches
- 1000kg wood top bench capacity
- 40mm thick laminated wooden top (V7240, V7242)
- 53mm thick laminated wooden top (V7306, V7307)
- Comes standard with adjustable feet for levelling on uneven floors and an optional lockable castor kit is available if required
- Bottom shelf benches available in both 1800 and 2100mm sizes
- Drawer Unit Capacity: 100kg per drawer
- Finish: Powder coated light grey



## Shelf Options

### Adjustable Shelf V7251 & V7252

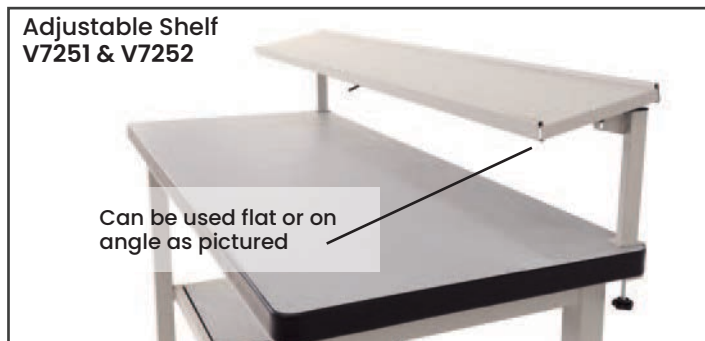

### 2 Tier Shelf V7254 & V7255



## Accessory Options

### Back Panel V7241 & V7243



### Lockable Castor Kit V7246







## Drawer &amp; Cabinet Options



**V7244 - 2 Drawer Unit**  
2 x 100mm drawers



**V7312 - 3 Drawer Unit**  
2 x 100mm, 1 x 200mm drawers



**V7315 - Cabinet Unit**



**V7245 - 6 Drawer Unit**  
2 x 75mm, 2 x 150mm,  
2 x 200mm drawers



Dividers supplied  
with all drawer units



Code	Details	Dimensions (mm)	Unit Weight (kg)
V7240	Industrial Workbench 1800mm	1800x750x900 (LxWxH)	66.5
V7242	Industrial Workbench 2100mm	2100x750x900 (LxWxH)	76.5
V7306	Industrial Workbench 1800mm (with bottom shelf)	1800x750x900 (LxWxH)	99
V7307	Industrial Workbench 2100mm (with bottom shelf)	2100x750x900 (LxWxH)	109

## Shelf Options

V7251	Adjustable Shelf to suit 1800mm bench	1800x250 (LxD)	11
V7252	Adjustable Shelf to suit 2100mm bench	2100x250 (LxD)	12
V7254	2 Tier Shelf Unit to suit 1800mm bench	1800x285 (LxD)	20
V7255	2 Tier Shelf Unit to suit 2100mm bench	2100x285 (LxD)	23
V7241	Back Panel Kit to suit 1800mm bench	1800x750x900 (LxWxH)	34
V7243	Back Panel Kit to suit 2100mm bench	21035x205x825 (LxWxH)	39

## Underbench Options

V7244	Lockable Drawer Unit (2 drawer)	565x650x280mm (WxDxH)	25.5
V7312	Lockable Drawer Unit (3 drawer)	565x650x450mm (WxDxH)	45.5
V7245	Lockable Drawer Unit (6 drawer)*	565x580x750mm (WxDxH)	85
V7315	Lockable Cabinet Unit (with shelf)	565x650x450mm (WxDxH)	14
V7246	Workbench Castor Kit (includes 4 swivel castors with brakes)		

\*Please Note: The V7245 (6 drawer unit) won't fit under the workbenches with bottom shelves



## Modular Ergonomic Packing Workbenches

- Our 2400mm Heavy Duty Modular Ergonomic Workbench comes with height adjustable legs for all your requirements or applications.
- It can be configured with a large range of accessories to maximise efficiency in your workspace.
- These benches are ideal for packing, industrial processes, workshops and multiple other applications. *Configure your bench today!*
- 37mm thick bench top, material is particle board with a PVC top & a high pressure, laminate underside
- 500kg capacity
- Comes standard with adjustable feet for levelling on uneven floors
- Finish: Powder coated light grey
- Bench Height: 737 to 1037mm – can adjust at 50mm increments



SCAN to *view* our full range of Modular Ergonomic Workbenches

Visit [verdex.com.au/industrial-workplace-equipment/modular-workbenches/](http://www.verdex.com.au/industrial-workplace-equipment/modular-workbenches/) to view our full range of workbenches & accessories to create your own workspace



## Accessories to suit Workbenches

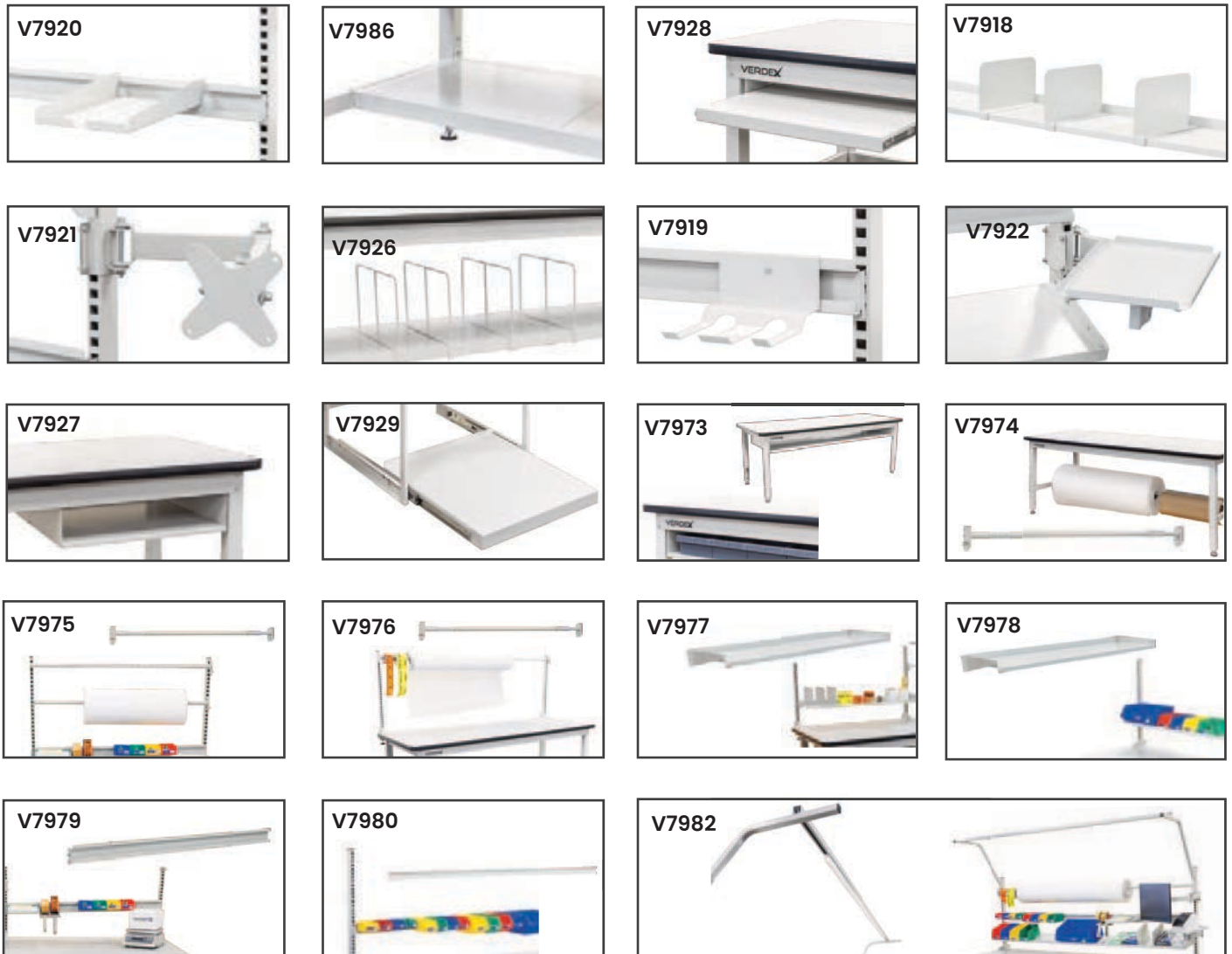

Code	Accessories to suit
V7918	Back Panel Shelf Divider
V7919	Back Panel Tape Dispenser Holder
V7920	Back Panel A4 Document Holder
V7921	Back Panel Monitor Arm
V7922	Back Panel Label Printer Arm
V7926	Under Shelf Divider (300mm high)
V7927	Under Shelf Tool Holder
V7928	Under Shelf Slide Out Keyboard Shelf
V7929	Under Shelf Slide Out CPU/Printer Shelf
V7986	Under Shelf Kit

Code	Full Length Accessories
V7973	Underbench Tool Shelf Unit
V7974	Underbench Roll Holder
V7976	Back Panel Roll Holder
V7978	Back Panel Reversible/Tilting Shelf
V7980	Back Panel Bin Rail
V7982	Back Panel Light & Balancer Rail

Code	Half Length Accessories
V7975	Back Panel Roll Holder
V7977	Back Panel Reversible/Tilting Shelf
V7979	Back Panel Bin Rail



# CUSTOM CONFIGURATIONS OF ERGONOMIC PACKING BENCHES



*Visit our website to create your ideal workspace*





# BUILD YOUR OWN WORKBENCH USING OUR ONLINE CONFIGURATOR

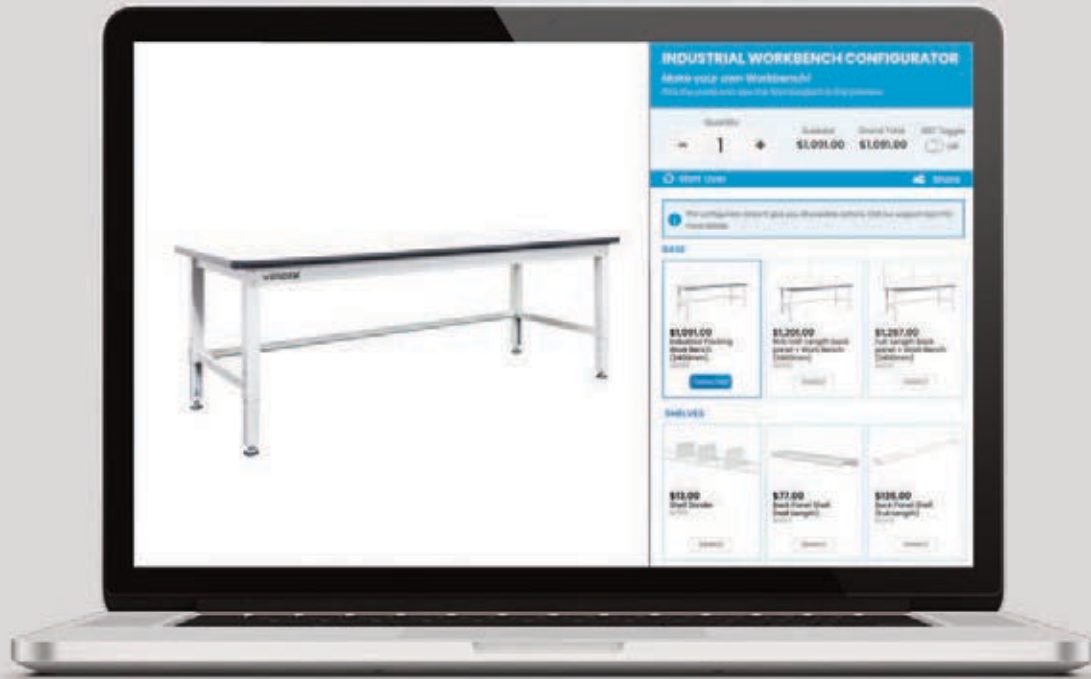

Scan here for our online Configurator Page

[www.verdex.com.au/workbench-configurator](http://www.verdex.com.au/workbench-configurator)



MODULAR WORKBENCH  
**Before & After**  
Initial - Full Kit Configuration

## Stainless Steel Benches

- Ideal for hospitality, pharmaceutical and medical
- 1.2mm thick 304 grade stainless steel top & undershelf
- 201 grade stainless steel legs
- Easy to wipe clean and keep hygienic
- Six widths available from 900mm to 2400mm
- Bench Depth: 600mm
- Bench Height: 900mm
- Supplied flat packed ready for assembly

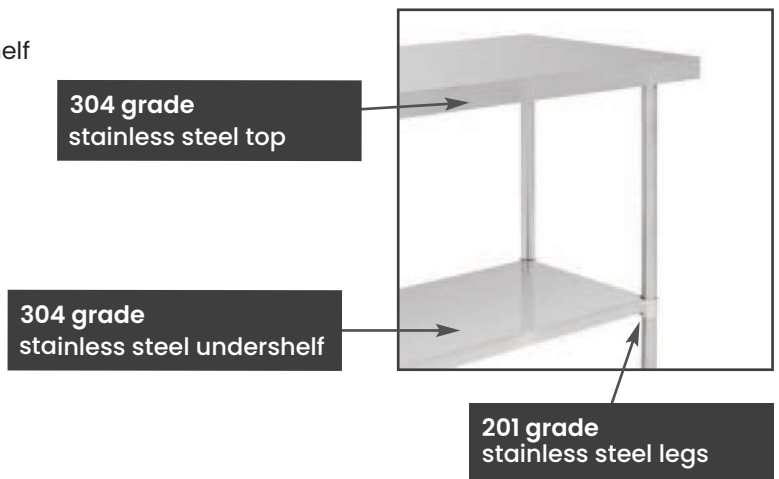

Code	Details
V8200	Stainless Steel Bench 900x600x900mm (WxDxH)
V8201	Stainless Steel Bench 1200x600x900mm (WxDxH)
V8202	Stainless Steel Bench 1500x600x900mm (WxDxH)
V8203	Stainless Steel Bench 1800x600x900mm (WxDxH)
V8205	Stainless Steel Bench 2400x600x900mm (WxDxH)





## Stainless Steel Benches (With Splashback)

- 1.2mm thick 304 grade stainless steel top and undershelf
- 201 grade stainless steel legs
- 100mm splashback to stop items falling down back of bench
- Easy to wipe clean and keep hygienic
- Seven widths available from 600mm to 2400mm
- Bench Height with Splashback: 1000mm



Code	Details
V8220	Stainless Steel Bench with splashback 600x600x900mm (WxDxH)
V8221	Stainless Steel Bench with splashback 900x600x900mm (WxDxH)
V8222	Stainless Steel Bench with splashback 1200x600x900mm (WxDxH)
V8223	Stainless Steel Bench with splashback 1500x600x900mm (WxDxH)
V8224	Stainless Steel Bench with splashback 1800x600x900mm (WxDxH)
V8225	Stainless Steel Bench with splashback 2100x600x900mm (WxDxH)
V8226	Stainless Steel Bench with splashback 2400x600x900mm (WxDxH)



## Stationery Cabinets

- Versatile, functional & practical steel office furniture allows freedom to create & configure storage solutions to suit your individual requirements.
- Supplied fully assembled
- All Cupboards are Key lockable
- Available in 1/2 Height and Full Height Sizes
- Full height cabinet comes standard with 3 shelves and 1/2 height cabinet comes standard with 1 shelf (extra shelves available)
- Shelf Thickness: 25mm
- Shelf Capacity: 40kg
- Extra Shelves are supplied with clips



V7071



V7070

V7072 - Optional Extra Shelves

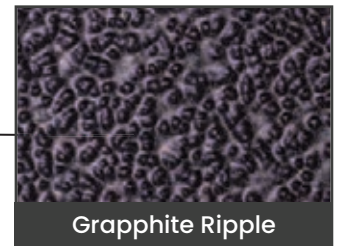
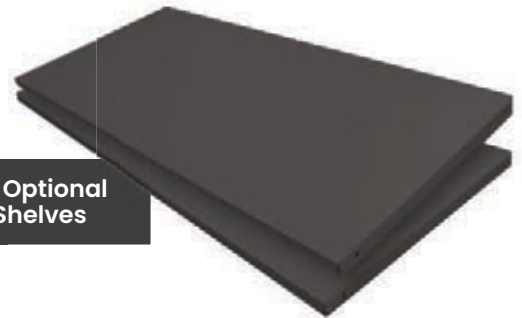

Grappphite Ripple

Code	Details	Overall Dimensions HxWxD (mm)	Unit Weight (kg)
V7070	Half Height Stationery Cabinet (Dark Grey)	1015x910x450	28
V7071	Full Height Stationery Cabinet (Dark Grey)	1830x910x450	44
V7072	Extra Shelf to suit V7070 & V7071	900x390	-



# 5 Tier Shelving Unit with Adjustable Feet

- This unit is used for displaying or storing food products and can also be used in warehouses, retail stores, offices etc.
- Includes five shelves
- Adjustable feet
- Overall Capacity: 400kg
- Shelf Capacity: 120kg
- Tray Size (LxW): 915x520mm



Code	Overall Size LxWxH (mm)	Tray Size (mm)	Unit Weight (kg)
V7090	920x520x1800	915x520	24

## CHECK OUT THE 3 TIER UTILITY CART



See page 41





## Open Steel Shelving Unit

- This Open steel shelving Unit is roll formed from durable premium pre-painted steel
- Designed for office and warehouse applications
- Comes with 4 Shelves
- Optional shelves sold as a pair only, available (Can fit up to 14 shelves at 118 pitch)
- Powder coat Finish
- Max. Capacity: 250kg
- Shelf Capacity: 50kg

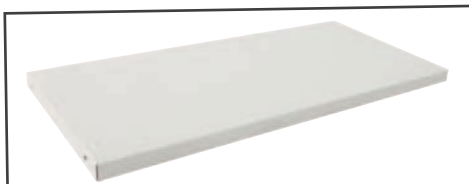

V7076 - Optional Extra Shelf



Code	Details	Overall Size LxWxH (mm)	Unit Weight (kg)
V7085	Open Steel Shelving Unit	890x455x2200	40
V7086	Open Steel Shelving Unit Extra Shelves	887x420x25	3.25

## Steel Shelving Parts Tray Kits

- This steel shelving is roll formed from premium pre-painted steel to ensure durability and engineering integrity for both office and warehouse storage applications.
- Colour: Silver Grey
- Supplied flat packed - Easy to assemble
- 100kg shelf load capacity
- Max Load Capacity Per Bay: 200kg
- Overall Size (LxwxH): 890x455x2200mm



**IH-017**  
Parts Trays  
Size LxWxH:  
400x100x100mm  
(with 3 dividers)



**IH-025**  
Parts Trays  
Size LxWxH:  
400x200x100mm  
(with 3 dividers)



V7082



V7083



V7084

Code	Details	Unit Weight (kg)
V7082	Shelf Unit Kit (includes 120 x IH-017 parts trays)	118
V7083	Shelf Unit Kit (includes 60 x IH-025 parts trays)	95
V7084	Shelf Unit Kit (includes 48 x IH-017 & 32 x IH-025 parts trays)	105



## Heavy Duty Parts Cabinet (30 Parts Trays)

- These Heavy Duty Parts Cabinets are a great way to store parts neatly and efficiently
- Parts Trays have a transparent front window to easily view product inside
- Parts trays have a raised back lip
- Each bin comes with one divider and one bin label card
- Different color tags can be applied for easier identification
- External Plastic Parts Bin Size (LxWxH): 415x170x105mm
- Internal Plastic Parts Bin Size (LxWxH): 380x140x100mm



Code	Details	Parts Bin Capacity (kg)	Overall Size WxDxH (mm)	Unit Weight (kg)
V7350	Heavy Duty 30 Parts Cabinet	10	900x420x880	51
V7353	Optional Dividers to suit V7350 (available seperately to parts trays)			

## Heavy Duty Parts Cabinet (60 Parts Trays)

- These Heavy Duty Parts Cabinets are a great way to store parts neatly and efficiently
- Parts Trays have a transparent front window to easily view product inside.
- Parts trays have a raised back lip
- Each bin comes with one divider and one bin label card
- Different color tags can be applied for easier identification
- External Plastic Parts Bin Size (LxWxH): 415x170x105mm
- Internal Plastic Parts Bin Size (LxWxH): 380x140x100mm



Code	Details	Parts Bin Capacity (kg)	Overall Size WxDxH (mm)	Unit Weight (kg)
V7351	Heavy Duty 60 Parts Cabinet	10	900x420x1760	110
V7353	Optional Dividers to suit V7351 (available seperately to parts trays)			



# Palomat Greenline Pallet Dispenser

- No manual pallet handling - reduces back strain from manually lifting pallets
- Space saving and a tidy workplace
- Optimised pallet flow
- Improved work environment
- Fewer back injuries, jammed fingers, and feet
- Stainless steel version available if required
- Increased efficiency
- No of Pallets: 15
- Suits Australian Chep and Loscam sized pallets
- Noise Level: 70 dBa
- Power: 220-240VAC / 50 Hz
- Can be adjusted for cool-room environments down to -25°C
- Fully electric operation
- Warranty: 12 months
- Made in Denmark



Watch a video of this in operation on our website here: [www.verdex.com.au/V7745](http://www.verdex.com.au/V7745)



Suits Australian Chep & Loscam pallets



V7745 pictured without pallets



Control Panel

Code	Lifting Capacity (kg)	Overall Size WxDxH (mm)	Unit Weight (kg)
V7745	700	1705x1520x2350	420

# Semi-Auto Strapping Machine

- Power Supply: 240V
- Electric adjustment for strap length and tension
- PP Strapping Width: 5 - 15.5mm
- PP Strapping Thickness: 0.6-1.0mm
- Max Strapping Tension: 5-40kg
- Strapping Speed: 2.5 Seconds/Strap
- Table Height: 750mm



Code	Max Loading Weight (kg)	Machine Dimensions LxWxH (mm)	Unit Weight (kg)
V7760	180	785x545x750	60



Watch a video of this in operation on our website here: [www.verdex.com.au/V7760](http://www.verdex.com.au/V7760)







# Stretch Wrapping Machines

- Electronic screen with 'Soft Touch' control
- Variable film carriage and turntable speeds
- Photocell eye for automatic height detection
- Automatic and Manual wrapping programs
- Soft-start and stop turntable drive
- 250% Pre-Stretch film carriage
- Power supply: 240v, single phase
- Ramp can be positioned anywhere around the turntable
- Ramp Finish: Powercoated Blue
- Ramp Overall Size (WxLxH): 1000x1500x80mm
- Ramp Weight: 56kg
- Heavy-duty industrial chain driven turntable
- Forklift relocation slots for easy machine transportation
- Rugged steel construction for long-term reliability
- Standard 12 month warranty
- Load capacity: 1500kg
- Fork Pocket Size: 154x54mm
- Fork Pocket Centres: 570mm
- Max height of wrapping: 2100mm
- Max pallet size: 1200x1200mm
- Overall Machine Dimensions (LxWxH): 2455x730x2200mm
- Turntable diameter: 1500mm
- Turntable Height: 80mm
- Turntable speed: 1-12 RPM
- Stretch film size: 500mm (width)
- Maximum film roller diameter: 250mm
- Maximum film roller inner diameter: 76mm
- V7741 Unit Weight: 415kg
- V7742 Unit Weight: 435kg



V7741 Control Panel



V7742 Control Panel

V7742 pictured with V7743 (optional ramp to suit)



V7741



Watch a video of this in operation on our website here: [www.verdex.com.au/V7742](http://www.verdex.com.au/V7742)



Code	Details
V7741	Semi-Auto Stretch Wrapping Machine
V7742	Full-Auto Stretch Wrapping Machine
V7743	Optional Ramp to suit Wrapping Machines



## Shipping / Parcel Scales

- Low profile design
- Rigid construction
- Remote display unit for weighing ease
- Hold or net / gross function
- Unit conversion available (KG/LB/OZ)
- Large and bright easy-to-read LCD display
- Auto-off function for power saving in seconds (120, 180, 240, 360, off optional)
- Rechargeable Battery and AC adaptor supplied
- Function Keys: Zero, Tare, Hold, Unit, On/Off

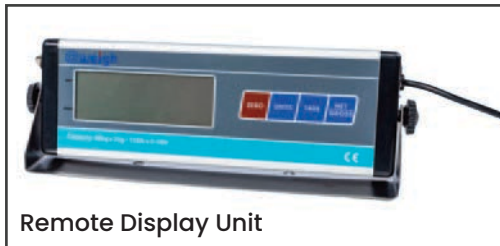

Remote Display Unit

Code	Details	Load Capacity (kg)	Platform Size (mm)	Unit Weight (kg)
V7703	Parcel Scale (10g increments)	30	310x310	5
V7706	Parcel Scale (20g increments)	60	405x355	6

## Floor Pallet Scales

- Great for weighing pallets and large bulky and heavy items
- Adjustable levelling feet for uneven ground
- Can be pit mounted so that it sits flush with the ground
- Low Profile 70mm height from ground level
- Construction: Mild Steel
- Power Supply: 240 V
- Increments: 500g



Code	Details	Load Capacity (kg)	Platform Size LxWxH (mm)	Unit Weight (kg)
V7700	2000kg Capacity Floor Pallet Scales	2000	1200x1200x70	75
V7701	3000kg Capacity Floor Pallet Scales	3000	1200x1200x70	75



## Pedestal Industrial Fan

Quality robust construction designed for everyday use in industrial workshops or warehouses.

- Includes optional Wall Mount Bracket
- Powder Coated Steel Frame
- Oscillating function
- Motor: 240v, 3 Speed
- Blade Diameter: 750mm

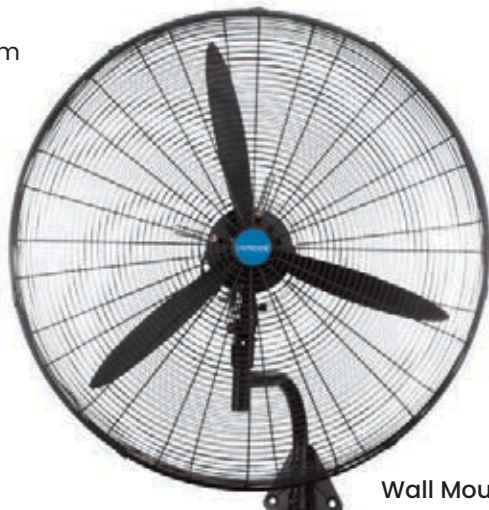

Wall Mount option



Height fully extended

Code	Lowered Height (mm)	Extended Height (mm)	Overall Size LxWxH (mm)	Unit Weight (kg)
V6432	1550	1880	1880x750x600	18.3

## Industrial Mobile Fan

- Plastic construction
- Maximum Speed: 480r/min
- Voltage Frequency: 220-240V/50Hz
- Motor Power: 600W
- Motor Type: Permanent magnet motors with variable speeds
- Airflow: 42000m<sup>3</sup>/min



Code	Blade Diameter (mm)	Overall Size LxWxH (mm)	Unit Weight (kg)
V6434	1500	1570x760x1960	58





# Stor-Pak Parts Bins

- Strong polypropylene bins which are ideal for parts and products storage
- Sit on shelves, benches, stack them or clip them to louvre panels
- All Stor-Pak bins are stackable
- Available in green, blue, red, yellow and clear
- Optional dividers available for #60, #120 and #240 bins
- Hospital grade material - bacterial free and chemical free
- Bin colours available:



Green Blue Red Orange Yellow Clear



Size #5



Size #10



Size #25



Size #60



Size #80



Size #120



Size #240

Code	Details	Size WxDxH (mm)	Volume (L)	Ctn Qty	Unit Weight (kg)
IH-060	Stor-Pak Bin #5	100x115x60	0.5	12	0.05
IH-061	Stor-Pak Bin #10	100x170x85	1.0	6	0.09
IH-062	Stor-Pak Bin #25	133x220x125	2.5	6	0.2
IH-063	Stor-Pak Bin #60	200x275x165	6.0	6	0.5
IH-200	Stor-Pak Bin #80	200x440x165	8.0	6	0.6
IH-064	Stor-Pak Bin #120	410x275x165	12	5	0.8
IH-065	Stor-Pak Bin #240	410x440x210	24	4	1.3
<b>Dividers</b>					
IH-058	Stor-Pak Dividers (suits bins #60 and #120)			40	0.3
IH-057	Stor-Pak Dividers (suits bins #240)			45	0.1

\*Please specify colour when placing your order



# Spare Parts Trays

- Strong polypropylene oil resistant trays which are supplied with dividers
- Extra dividers are available to create more compartments in the trays
- Ideal for small parts storage
- Hospital grade material - bacterial free and chemical free



Code	Details	Size LxWxH (mm)	Dividers Supplied	Ctn Qty
IH-012	Spare Parts Tray #12	300x100x100	2	24
IH-017	Spare Parts Tray #17	400x100x100	2	24
IH-027	Spare Parts Tray #27	600x100x100	5	12
IH-024	Spare Parts Tray #24	300x200x100	2	12
IH-025	Spare Parts Tray #25	400x200x100	2	12
IH-028	Spare Parts Tray #28	600x200x100	5	6
IH-230	Spare Parts Tray #30	300x300x100	2	8
IH-231	Spare Parts Tray #31	400x300x100	2	8
IH-232	Spare Parts Tray #32	600x300x100	5	4
<b>Dividers</b>				
IH-014	Spare Parts Dividers-100mm wide			12
IH-026	Spare Parts Dividers-200mm wide			12
IH-233	Spare Parts Dividers-300mm wide			12

# Mesh-Pak Storage Bins

- The ultimate practical storage system and part of the stor-pak range
- Available in three sizes to accommodate small as well as bulky items
- Produced in tough and durable hospital grade material - bacterial free and chemical free
- Angled front provides easy picking access
- Perforated bottom ensures no dust collects at the bottom of the box
- Dividers available for Stor-Pak #60 and #120
- Colours Available: Blue or Clear



Size #10



Size #25



Size #60



Size #120



Code	Details	Size WxDxH (mm)	Volume (L)	Ctn Qty	Unit Weight (kg)
IH-061MPB	Mesh-Pak Bin #10-Blue	100x170x85	1.0	6	0.09
IH-061MPC	Mesh-Pak Bin #10-Clear	100x170x85	1.0	6	0.09
IH-062MPB	Mesh-Pak Bin #25-Blue	133x220x125	2.5	6	0.2
IH-062MPC	Mesh-Pak Bin #25-Clear	133x220x125	2.5	6	0.2
IH-063MPB	Mesh-Pak Bin #60-Blue	200x275x165	6.0	6	0.5
IH-063MPC	Mesh-Pak Bin #60-Clear	200x275x165	6.0	6	0.5
IH-064MPB	Mesh-Pak Bin #120-Blue	410x275x165	12	5	0.8
IH-064MPC	Mesh-Pak Bin #120-Clear	410x275x165	12	5	0.8

### Dividers

IH-058	Dividers (to suit bins #60 & #120)			40	
--------	------------------------------------	--	--	----	--





# Visi-Pak Storage Bins

- Fully modular the Visi-Pak is supplied with special clips which enable them to fit onto a louvre panel - doors swivel forward for easy access
- They can also be screwed onto a wall or left free standing on a bench top
- Ideal for small parts storage
- Available in 3 standard sizes
- Hospital grade material - bacterial and chemical free

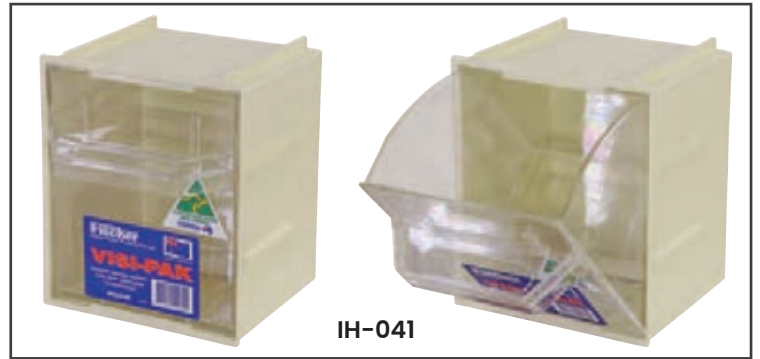

Code	Details	Size WxDxH (mm)	Volume (L)
IH-040	Visi-Pak - Small	103x83x120	0.25
IH-041	Visi-Pak - Medium	154x126x180	1.5
IH-042	Visi-Pak -Large	208x167x235	3.5



## Drawer Organisers

- Ideal for storing nuts, bolts, screws etc
- Can be mounted onto louvre panel or screwed directly onto a wall
- Blue with clear drawers
- Hospital grade material - bacterial free and chemical free
- Material: Durable Co-Polymer



Code	Details	Unit Size WxDxH (mm)	Drawer Size WxDxH (mm)
IH-048	Drawer Organiser (2 drawer)	87x136x98	70x125x40
IH-044	Drawer Organiser (3 drawer)	155x125x140	145x125x40
IH-050	Drawer Organiser (12 drawer)	230x128x188	70x125x40
IH-051	Drawer Organiser (20 drawer)	305x128x230	70x125x40

## Ezi-Pak Carry Case

- Tough carry cases for tools and accessories
- Made from ABS plastic with polycarbonate lids
- Comes with removable dividers (21 compartments)
- Removable dividers
- Available in Red and Blue
- Modular frame which is great for use in vehicles or can be mounted to a workbench and can have multiple modules stacked on top of each other
- Modular frame is self locking



IH-156

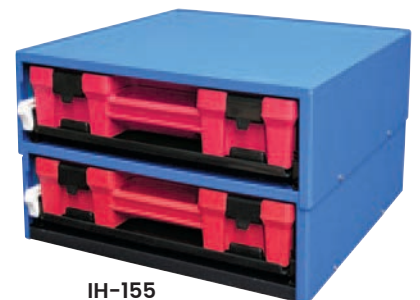

IH-155



IH-150B



IH-150R



IH-151B



Code	Details	Overall Size WxDxH (mm)
IH-150B	Ezi-Pak Accessory Case- Blue (with clear lid)	370x432x85
IH-150R	Ezi-Pak Accessory Case- Red (with clear lid)	370x432x85
IH-151B	Ezi-Pak Accessory Case- Blue (with blue lid)	370x432x85
IH-156	Ezi-Pak Accessory Case Modular Frame (fits 2 cases, not included)	415x435x270
IH-155	*Ezi-Pak Accessory Case Modular Frame (complete with 2 cases)	415x435x270

\*This comes with red or blue lid cases (please specify colour when ordering)



## Clear Accessory Boxes

- Clear Compartment Accessory Boxes which are great for storing small parts and accessories
- All plastic construction
- Made from quality clear plastic for easy viewing
- Big range to suit your needs
- Protects goods from dirt & dust
- Quality catch for secure locking
- Endless uses



IH-033



IH-029



IH-038



IH-031



IH-030



IH-039



IH-032



IH-092



IH-093



IH-094



IH-096



IH-090



IH-095



IH-097



IH-091

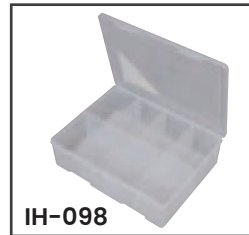

IH-098



IH-088

Code	Details	Overall Size LxWxH (mm)	Compartments	Ctn Qty
IH-031	Small - 1 compartment	188x118x31	1	12
IH-030	Small - 5 compartments	188x118x31	5	12
IH-033	Small - 10 compartments	188x118x31	10	12
IH-029	Medium - 1 compartment	195x157x48	1	12
IH-038	Medium - 6 compartments	195x157x48	6	12
IH-039	Medium - 14 compartments	195x157x48	14	12
IH-032	Medium Deep - 1 compartment	195x136x66	1	14
IH-092	Large - 1 compartment	310x200x48	1	5
IH-093	Large - 12 compartments	310x200x48	12	5
IH-094	Large - 18 compartments	310x200x48	18	5
IH-096	Large Deep - 1 compartment	310x200x80	1	3
IH-090	Large Deep - 3 compartments	310x200x80	3	3
IH-095	Large Deep - 6 compartments	310x200x80	6	3
IH-097	Extra Large- 20 compartments	350x270x55	20	5
IH-091	Extra Large Extra Deep - 1 compartment	350x270x100	1	3
IH-098	Extra Large Extra Deep - 8 compartment	350x270x100	8	3
IH-088	A4 Size - 1 Compartment	315x230x71	1	3





# Louvre Panel & Square Hole Boards & Accessories

- These wall mountable panels are available with louvre panel slots or square pegboard holes for hanging items
- Panels can be mounted onto benches, walls, racking, shelving trolleys and more
- Large range of hanging hooks accessories available



V7291

Rear View

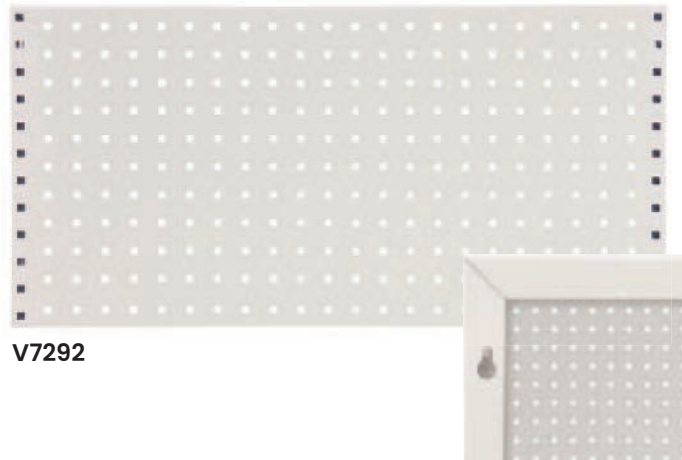

V7292

Rear View



V7280



V7281



V7282



V7283



V7284



V7285



V7286



V7287



V7288



V7289



V7290

Code	Details	Overall Size (mm)	Unit Weight (kg)
V7291	Metal Louvre Panel Board	900x455x20 (WxHxD)	5kg
V7292	Metal Square Hole Pegboard	900x455x20(WxHxD)	5kg
V7280	Single Hook	25mm long	0.10g
V7281	Single Hook	75mm long	0.35g
V7282	Single Hook	150mm long	0.5g
V7283	Double Hook	25mm long	0.5g
V7284	Double Hook	75mm long	0.7g
V7285	U Shape Hook	23x35mm (LxW)	0.95g
V7286	U Shape Hook	70x25mm (LxW)	0.7g
V7287	3 Prong Hook	150mm long	0.14g
V7288	Round Hook	100x70mm (LxW)	0.85g
V7289	Spanner Holder	135mm long	0.4g
V7290	Screwdriver Holder	390mm long	0.46g



# Louvre Panels (Metal & ABS Plastic)

- These louvre panels are available in both metal and ABS plastic and can be used for many applications including workbenches, packing areas, walls, shelving etc
- 4 standard sizes in the metal louvre panel and 2 standard sizes in the ABS plastic panels



V7297

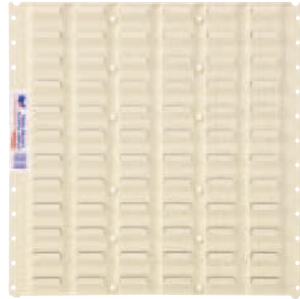

V7298

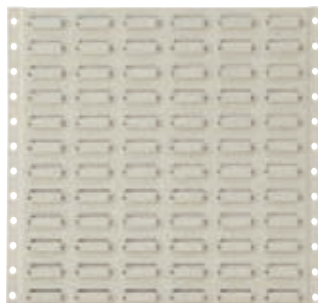

V7293

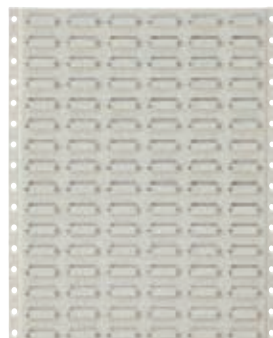

V7294

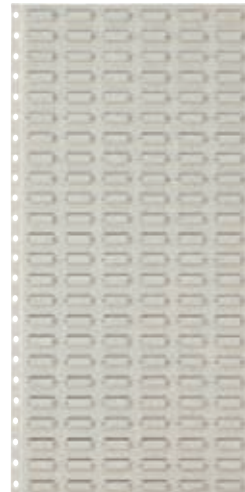

V7295

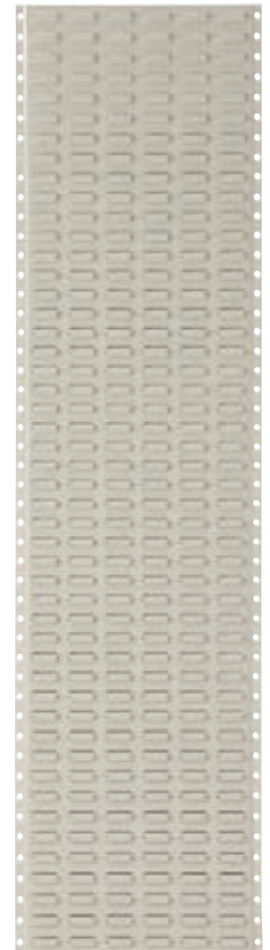

V7296

Code	Details	Overall Size WxH (mm)	Unit Weight (kg)
V7293	Metal Louvre Panel Board	455x455	2.5
V7294	Metal Louvre Panel Board	455x610	3.3
V7295	Metal Louvre Panel Board	455x914	5
V7296	Metal Louvre Panel Board	450x1800	10
V7297	ABS Plastic Louvre Panel Board	460x153	0.2
V7298	ABS Plastic Louvre Panel Board	460x460	0.5

**You  
May  
Also  
Like**



**Electric Workbenches - View online!**



# Enviro Plastic Stack & Nest Crates

## (Recycled Plastic)

- These recycled stack and nesting crates are injection moulded from tough, durable, UV resistant recycled polypropylene.
- Crates can stack or nest depending on which way around they are stored
- Size 4 and 4D are nest only



	Size #4	Size #4D	Size #7	Size #10	Size #15
<b>Code</b>					
<b>Details</b>					
<b>Internal Size LxWxD (mm)</b>					
<b>External Size LxWxD (mm)</b>					
<b>Capacity (L)</b>					
<b>Unit Weight (kg)</b>					
V7820	No. 4 Bins (Black Recycled)		390x280x120	430x323x127	13.5
V7821	No. 4D Bins (Black Recycled)		390x280x205	430x323x210	22
V7822	No. 7 Bins (Black Recycled)		490x330x200	645x413x210	32
V7823	No. 10 Bins (Black Recycled)		490x330x260	645x413x276	52
V7824	No. 15 Bins (Black Recycled)		490x330x385	645x413x397	68
<b>Lids to suit</b>					
V7825	Bin Crate Lids to suit No. 4 crates (Black Recycled)				-
V7826	Bin Crate Lids to suit No. 7-15 crates (Black Recycled)				-

# Stack & Nest Crate Dollies

- Industrial strength – made from heavy duty, durable recycled PP material
- V7840 & V7843: Zinc plated Castors
- V7841: Stainless Castors
- V7840 & V7841: Wheel wells to allow for stackable, secure storage (when not in use)
- V7840 & V7841: Rear castors with brakes to secure when stopped on an incline.
- Designed to fit our number 7, 10 or 15 stack and nest bin
- V7843 Suits Crate Base Sizes: 570x370mm & 545x355mm



Code	Details	Load Capacity (kg)	Internal Dimensions (LxWxH) mm	Overall Dimensions (LxWxH) mm	Unit Weight (kg)
V7840	Enviro Dollie Dark Grey Frame	600	580x370x15 (lip)	615x405x190	6
V7841	Enviro Dollie Blue Frame	600	580x370x15 (lip)	615x405x190	6
V7843	Stack & Nest Crate Dollie Blue Frame	250	see main description	610x405x170	4.5





## Plastic Stack & Nest Crates (Virgin Plastic)

- These stack and nesting crates are injection moulded from tough, durable, UV resistant polypropylene. They are suitable for food handling, engineering, warehousing or distribution
- Crates can stack or nest depending on which way around they are stored
- Size 4 and 4D are nest only
- Available in 5 colours (please specify your preferred colour when ordering)
- Colours Available:



Blue Red White Green Yellow



Stack and Nestable



Size #4

Size #4D

Size #7

Size #10

Size #15

Code	Details	Size LxWxD (mm)	Capacity (L)	Unit Weight (kg)
V7830	No. 4 Bins	430x323x127	13.5	0.62
V7831	No. 4D Bins	430x323x210	22	0.77
V7832	No. 7 Bins	645x413x210	32	1.6
V7833	No. 10 Bins	645x413x276	52	1.8
V7834	No. 15 Bins	645x413x397	68	2.4

### Lids to suit

V7835	Bin Crate Lids to suit No. 4 crates (Black or white)			0.2
V7836	Bin Crate Lids to suit No. 7-15 crates (Black or white)			0.2

\*Please specify colour when placing order

# Access Plastic Bin Rack

- These access bin racks store and display products for easy access and stock picking
- Extra strong powder coated frames and beams
- Rack fits the No. 4D size bins (choice of 6 colours)
- Available in 2 standard sizes
- This rack can have castors fitted for easy maneuverability
- V8100 Access Plastic Bin Racking: 1800x1800x450mm
- V8101 Access Plastic Bin Racking: 2400x1800x450mm
- Add-on Bays available so you can make one continuous line of Access Bin Racking



Code	Details	Unit Weight (kg)
V8100	Access Plastic Bin Rack (includes 20 plastic bins)	64
V8100A	Access Plastic Bin Rack Add on Bay to suit V8100	55
V8101	Access Plastic Bin Rack (includes 28 plastic bins)	88
V8101A	Access Plastic Bin Rack Add on Bay to suit V8101	80
V7326	Castor Kit to suit (includes 4 castors with brakes)	



# Access Stor-Pak Bin Rack

- These access Stor-Pak bin racks store and display products for easy access and stock picking
- Stor-Pak bins are available in Red, Green, Blue or Yellow
- Stor-Pak Bin Size: 410x440x210mm (Length x Depth x Height)
- Extra strong powder coated frames and beams
- Available in 2 standard sizes
- This rack can have castors fitted for easy maneuverability
- V8105 Access Plastic Bin Racking: 1800x1800x450mm
- V8106 Access Plastic Bin Racking: 2400x1800x450mm
- Add-on Bays available so you can make one continuous line of Access Bin Racking



V8105



V8105A



V8106



V8106A



### Bin Colours Available



IH-065G

IH-065Y

IH-065OR

IH-065R

IH-065C

IH-065B

Code	Details	Unit Weight (kg)
V8105	Access Stor-Pak Rack (includes 16 plastic bins)	72
V8105A	Access Plastic Bin Rack Add on Bay to suit V8105	63
V8106	Access Stor-Pak Rack (includes 20 plastic bins)	97
V8106A	Access Plastic Bin Rack Add on Bay to suit V8106	88
V7326	Castor Kit to suit (includes 4 castors with brakes)	





## Multistaka Crates

- Industrial strength – made from heavy duty, durable PP material
- Food grade material
- Available in white and blue colour
- Lids available in white only



V7850W

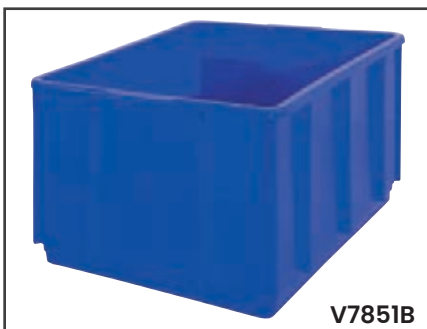

V7851B



V7852W



V7853



Code	Details	Internal Size LxWxH (mm)	Overall Size LxWxH (mm)	Unit Weight (kg)
V7850B	Blue Multistaka Crate – 13 Litre	375x275x120	432x324x127	0.78
V7850W	White Multistaka Crate – 13 Litre	375x275x120	432x324x127	0.78
V7851B	Blue Multistaka Crate – 22 Litre	375x275x210	432x324x203	1
V7851W	White Multistaka Crate – 22 Litre	375x275x210	432x324x203	1
V7852B	Blue Multistaka Crate – 32 Litre	375x275x300	432x324x305	1.4
V7852W	White Multistaka Crate – 32 Litre	375x275x300	432x324x305	1.4
V7853	Multistaka Crate Lid	-	438x330	-

## Plastic Pails With Lids

- These plastic pails are great for food and industrial applications
- 4 standard sizes available
- Stainless steel carry handle with plastic sleeve
- Australian made
- Supplied with lids
- Colour: White



Code	Details	Overall Size DxH (mm)	Unit Weight (kg)
V7854	Plastic Pail & Lid – 5L	204x176	0.62
V7855	Plastic Pail & Lid – 10L	260x270	0.77
V7856	Plastic Pail & Lid – 15L	280x332	1.6
V7857	Plastic Pail & Lid – 20L	280x410	1.8



## Standard Plastic Export Pallet

Excellent pallets for one way use with no fumigation or heat treatment required.

- Suitable for food processing plants and pharmaceutical industries
- Passes all export regulations – ISPM -15 compliant
- Able to be hot washed, steam cleaned and chemically sterilised
- No nails or splinters
- Re-sell value after usage
- Material: Made from recycled plastic
- 2 types available - 2 way entry & 4 way entry



V7860



V7861

Code	Details	Static SWL (kg)	Overall Size LxWxH (mm)	Unit Weight (kg)
V7860	Standard Plastic Export Pallet-2 way entry	1000	1140x1140x120	7.7
V7861	Standard Plastic Export Pallet-4 way entry	1000	1100x1100x120	7.6

## Heavy Duty Hygiene Pallet

Heavy duty Environmentally friendly plastic pallets which are great for the food, pharmaceutical, grocery, printing, beverage and many other industrial applications.

- Static Capacity: 8000kg
- Beam Racking and Forklift Movement Capacity: 2000kg
- Drive-In Racking Capacity: 1000kg
- Material: Recycled polyethylene



**Please Note:** Capacity weights are approx only and we recommend that racking trials be carried out in each case

Code	Static SWL (kg)	Overall Size LxWxH (mm)	Unit Weight (kg)
V7865	10,000	1165x1165x150	33

## Vented Collapsible Bin & Lid

- Made from UV Stabilised PP
- Full recyclable and Food Grade Approved
- 3:1 Fold Down ratio
- 2 way forklift and pallet truck Entry
- Can safely stack up to 10 bins high when empty, 7 high at 300kg, 5 high at 500kg and 3 high and 700kg
- Pallet Rack Safe – Unique Positive Locking Base Design
- Racking Capacity 500kg
- Dynamic Capacity 1000kg
- Static Capacity 4000kg
- Bin Closed Dimensions (LxWxH): 1162x1162x270mm

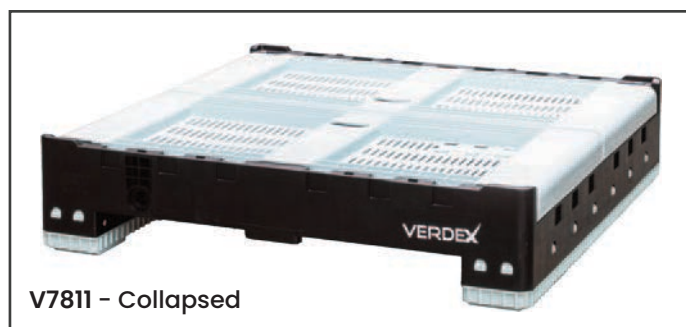

V7811 - Collapsed

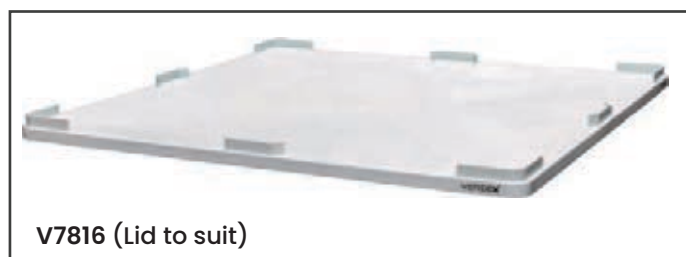

V7816 (Lid to suit)



V7811



V7812

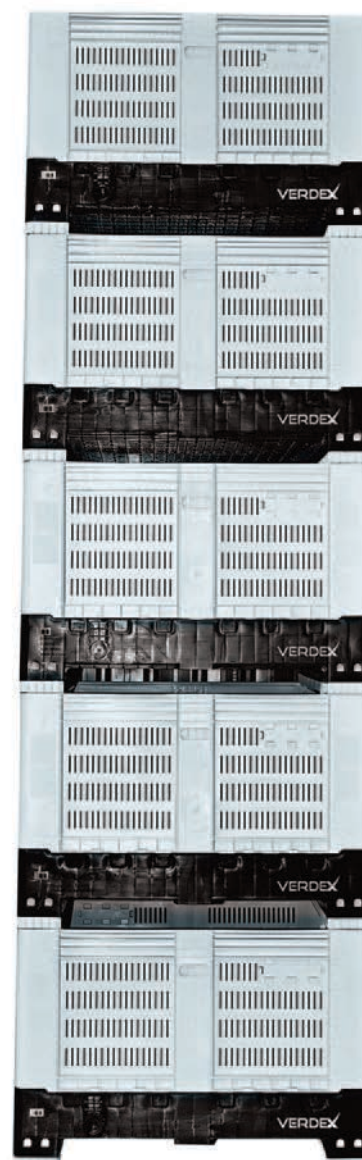

V7811 - Open & Stacked



Watch a video of this in operation on our website here: [www.verdex.com.au/V7811](http://www.verdex.com.au/V7811)



Code	Details	Volume (L)	Open Dimensions LxWxH (mm)	Internal Dimensions LxWxH (mm)	Unit Weight (kg)
V7811	Vented Collapsible Bin (Full Height)	730	1162x1162x780	1070x1070x630	46
V7812	Vented Collapsible Bin (Half Height)	352	1160x1160x460	1075x1075x300	35
V7816	Lid to suit V7811 & V7812	-	1172x1172x63	-	6.2





# Nally Plastic Mega Bins (Vented & Solid)

Designed for fruit and vegetable movement and retail high performance the Nally MegaBin is clearly the way of plastic produce bins in Australia. Nally Megabins are up to 40% lighter in weight than wood bins and the weight is constant as they don't absorb moisture. This allows for increased freight efficiencies of 4-5%. In practice you are able to transport 2-3 extra bins of fruit per semi-trailer load.

- Available in both solid and vented
- Mega Bin Rotator Base options available, to suit V7800 & V7810
- Standard pallet size (1165mm x 1165mm)
- Maximum load capacity: 500kgs



V7801 Mega Bin Rotator Base to suit V7800 & V7810



V7800 & V7810 - Stacked & pictured with V7815 (Lid to suit)



V7803 & V7800



V7810



V7800

Code	Details	Capacity	External Size LxWxH (mm)	Internal Size LxWxH (mm)	Unit Weight (kg)
V7800	Solid Mega Bin	780L	1165x1165x780	1082x1082x650	44
V7810	Vented Mega Bin	780L	1165x1165x780	1082x1082x650	44
V7815	Mega Bin Lid	-	1180x1180x35	-	10
V7801	Mega Bin Rotator Base	500kg	1070x900x140	1070x898x140	30
V7803	Mega Bin Rotator Base (with wheels)	500kg	1070x900x340	1070x898x140	38



# Mesh Transport Storage Cage

- Multi-purpose transport or storage cages which are great for storing products both indoor and outdoor.
- Pallet Rack Safe – unique positive locking base design for racking
- Features a Half Swing Removable Front Gate and a Hinged Removable Rear Gate
- Cages can be stacked 3 high, when loaded and 5 high when empty
- Finish: Zinc plated
- Supplied flatpacked
- Optional Gal Floor sold separately
- Optional Full Height Divider sold separately



Collapsed



Watch a video of this in operation on our website here: [www.verdex.com.au/V7530](http://www.verdex.com.au/V7530)



V7530 pictured with V7502



V7530 pictured with V7533



V7530 pictured with 2 x V7534

Code	Details	Load Capacity (kg)	Internal Size LxWxH (mm)	Overall Size LxWxH (mm)	Unit Weight (kg)
V7530	Mesh Storage Cage	1000	1070x1070x840	1160x1205x1041	80
V7502	Galvanised Floor to suit V7530	-	-	1140x1140x1.2	12
V7533	Lid to suit V7530	-	-	1130x1087x92	12.4
V7534	Full Height Divider to suit V7530	-	-	1135x750x41	6.2





# Low Height Storage Cage

- This Low Height Storage Cage is great for storing products both indoor and outdoor.
- Pallet Rack Safe – unique positive locking base design for racking
- Removable front gate
- Cages can be stacked 2 high when loaded
- 4 Way forklift & 2 Way Pallet Truck entry
- Finish: Zinc plated
- Supplied flatpacked
- Base Height: 125mm



Collapsed



Watch a video of this in operation on our website here: [www.verdex.com.au/V7529](http://www.verdex.com.au/V7529)



V7529 pictured with V7528



V7529 pictured with V7533

Code	Details	Load Capacity (kg)	Internal Size LxWxH (mm)	Overall Size LxWxH (mm)	Unit Weight (kg)
V7529	Low Height Storage Cage	1000	1070x1070x480	1160x1205x652	61
V7538	Half Height Divider to suit V7529	-	-	1125x345x25	4
V7533	Lid to to suit V7529	-	-	1130x1087x92	12.4





## Collapsible & Stackable Stillage Cage (Rectangular)

- Fork Pockets - 4 Side Fork Lift/2 Side Pallet Truck Access
- Pallet Racking Compatible (beam lock at long side)
- 3 Sided Half Drop Down Gate
- 1 Sided Swing Gate (Short Side)
- Pallet Rack Safe - Unique Locking Base Design
- Quick Collapsible sides so the unit can be quickly folded, stored and transported in the knock-down position
- Zinc Finish
- Compact Design - can be stacked when collapsed
- Optional Wheel Kit
- 2 License Plates on Short Sides
- Stackable (3) High Loaded, (4) High Empty, (6) High Collapsed
- 4 x Heavy Duty Low Profile Castors (2 x Swivel & 2 x Fixed)
- Fork Pocket Size: 132x85mm
- Fork Pocket Centre: 250mm

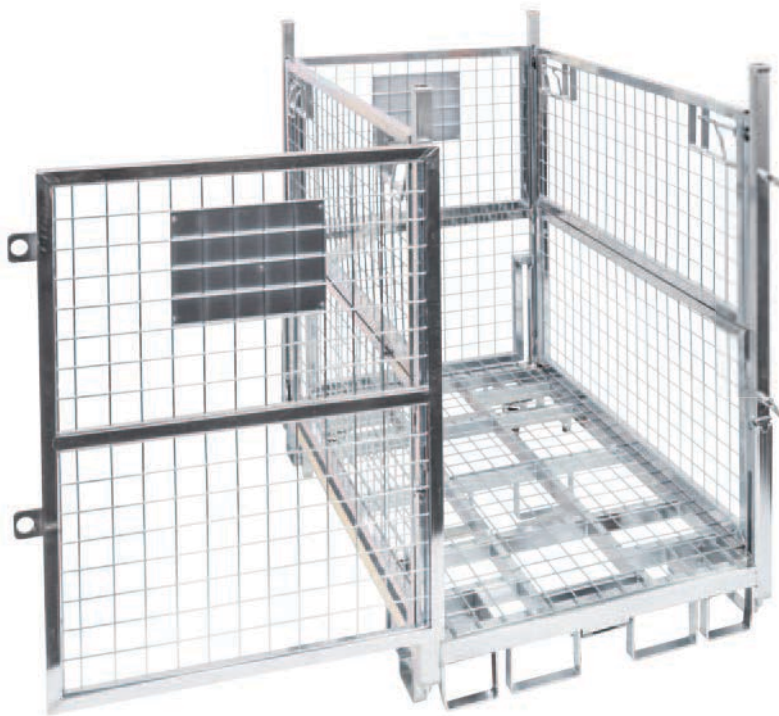

Pictured with V7562



Watch a video of this in operation on our website here: [www.verdex.com.au/V7561](http://www.verdex.com.au/V7561)



Code	Details	Load Capacity (kg)	Internal Size LxWxH (mm)	Overall Size LxWxH (mm)	Collapsed Height (mm)	Unit Weight (kg)
V7561	Collapsible & Stackable Stillage Cage	500	1090x680x925	1150x750x1170	425	74
V7562	Optional Wheel Kit to suit V7561					



# Collapsible and Stackable Stillage Cage

- Multi-purpose transport or storage cages which are great for storing products both indoor and outdoor.
- Great for storing products both indoor and outdoor
- Pallet Rack Safe – Unique Positive Locking Base Design
- Front and rear gates are removable and half fold down
- Quick collapse sides so the unit can be quickly folded, stored and transported in the knock-down position
- 4 way pallet truck and forklift entry
- Cages can be stacked 3 high when loaded and 10 high folded
- Finish: Zinc plated
- Mesh Size: 100x50x6mm
- If fitted with V7542 Wheel Kit, the overall load capacity of the V7541 will reduce to 800kg



V7541 pictured with V7542



V7541 pictured with V7534



V7541 pictured with V7533



V7541 Collapsed & Stacked



Watch a video of this in operation on our website here: [www.verdex.com.au/V7541](http://www.verdex.com.au/V7541)



Code	Details	Load Capacity (kg)	Internal Size (mm)	Overall Size LxWxH (mm)	Unit Weight (kg)
V7541	Collapsible & Stackable Stillage Cage	1200	1035x1035x805	1125x1125x1040	87
V7533	Lid to suit V7541	-	-	1130x1087x92	12.4
V7534	Full Height Divider to suit V7541	-	-	1135x750x41	6.2
V7542	Wheel Kit to suit V7541				





## Wire Pallet Cages

- Convert your pallets into cages with the quick and easy to use cages.
- Ideal for storing odd or awkward shaped goods/products
- Can be folded down flat for easy storage when not in use
- Mesh Size: 100x50mm - 6mm
- Pallet not included



Watch a video of this in operation on our website here: [www.verdex.com.au/V7514](http://www.verdex.com.au/V7514)



V7514



V7515

Code	Details	Overall Size LxWxH (mm)	Unit Weight (kg)
V7514	Half Height Wire Pallet Cage	1195x1170x400	28
V7515	Full Height Wire Pallet Cage	1195x1170x800	44

## Galvanised Mesh Cage

- These mesh cages are an excellent form of warehouse and yard storage.
- These units are stackable as well as having the capability of being stored on pallet racking
- Can be folded down flat for easy storage when not in use
- Can be safely stacked 2 high when in use



V7519



Watch a video of this in operation on our website here: [www.verdex.com.au/V7518](http://www.verdex.com.au/V7518)



Code	Details	Load Capacity (kg)	Folded Height (mm)	Mesh Size (mm)	Overall Size WxDxH (mm)	Unit Weight (kg)
V7518	Galvanised Mesh Cage	1000	210	100x50x6	1150x1150x890	64
V7519	Wheel Kit to suit V7518					







# Pallet Cages

- Multi-purpose transport or storage cage
- Great for storing products both indoor and outdoor
- These cages can also be stored on pallet racking
- V7509 features a drop down swing gate
- V7510 features a double swing gate
- Stackable Height: 2 high loaded, 4 high empty
- Supplied with a hardwood timber pallet
- Finish: Zinc Plated
- Load Capacity: 1000kg



V7510



V7509



V7509 pictured with V7528



V7509 pictured with V7533



V7510 pictured with V7534



V7510 pictured with V7533

Code	Details	Internal Size LxWxH (mm)	Overall Size LxWxH (mm)	Unit Weight (kg)
V7509	Stillage Pallet Cage (Half Height)	1080x1080x448	1200x1200x655	27
V7538	Half Height Divider to suit V7509	-	1125x345x25	4
V7510	Stillage Pallet Cage (Full Height)	1080x1080x825	1205x1165x1028	41
V7534	Full Height Divider to suit V7510	-	1135x750x41	6.2
V7533	Lid to to suit V7509 & V7510	-	1130x1087x92	12.4

# Stackable Stillage Cage

These stackable stillage cages are an excellent form of warehouse and yard storage. Designed to store long awkward objects for easy transport, these units may be stacked to make use of the vertical space in your warehouse.

- Fits standard Australian size pallets including Chep and Loscam
- Can be safely stacked 3 high when in use
- Finish: Zinc plated
- Base Material Size: RHS 30x60x1.8mm
- Post Size: 60x2.5mm
- Cupped feet add an additional 100mm to the external size (50mm per side)
- Clearance between ground and bottom frame is 110mm
- Clearance between stillages when stacked is 1545mm

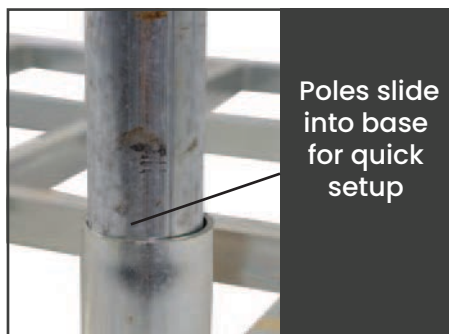

Watch a video of this in operation on our website here, [www.verdex.com.au/V7525](http://www.verdex.com.au/V7525)



Code	Load Capacity (kg)	Post Height from Top of Base (mm)	Internal Size LxWxH (mm)	External Size LxWxH (mm)	Base Height (mm)	Unit Weight (kg)
V7525	1000	1490	1250x1250x1490	1390x1390x1655	170	54





## Large Stackable Stillage Cage

These stackable stillage cages are an excellent form of warehouse and yard storage. Designed to store long awkward objects for easy transport, these units may be stacked to make use of the vertical space in your warehouse.

- Can be safely stacked 2 high fully loaded, 4 high empty
- Galvanised Finish
- Load Capacity: 1000kg
- Stillage Cage comes with optional accessories to suit.



V7589 Eye Nut for Lashing



V7588 Stopper/Divider



V7587 Fork Entry Bar

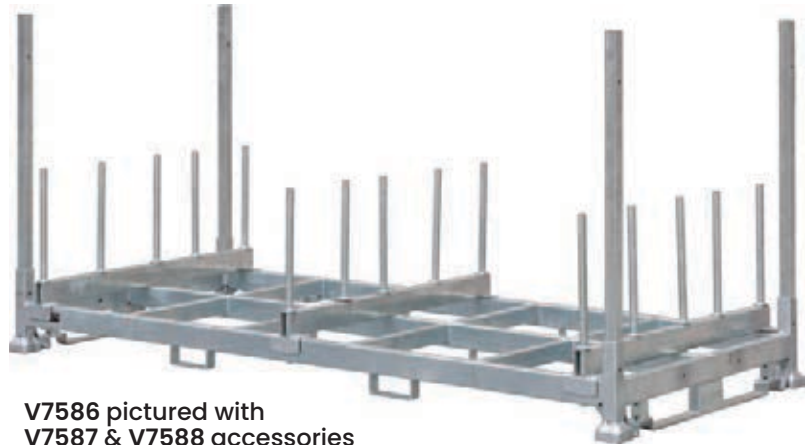

V7586 pictured with V7587 & V7588 accessories



V7586 in use & stacked 2 high

Code	Details	Fork Pocket Centre (mm)	Fork Pocket Size (mm)	Internal Size LxWxH (mm)	Overall Size LxWxH (mm)	Unit Weight (kg)
V7586	Large Stackable Stillage Cage	850	154x62	2410x1165x1025	2550x1165x1200	100
V7587	Fork Entry Bar to suit V7586	-	-	-	130x12x114	4.5
V7588	Stopper/Divider to Suit V7586	-	-	-	50x50x480	0.7
V7589	Eye Nut to suit V7586					
V7907	Towing Set to suit V7586					
V1283	Castor Kit to suit V7586 (160mm 2 x Swivel with brakes & 2 x fixed)					



## Double Width Storage Cage (Full Height)

- Front and rear gates fold down allowing for safe, easy and fast access to goods
- Pallet Rack Safe – unique positive locking base design
- Cage can be collapsed or assembled in seconds
- 4 Way forklift access & pallet truck entry
- Anti-tip base design
- Zinc plated finish
- Optional Full Height Divider sold seperately
- Stackable 2 high loaded, and 4 high empty
- Collapsed Height: 320mm



Stacked



V7540 Pictured with V7542



V7540 pictured with V7543 & V7534

Collapsed



Code	Details	Load Capacity (kg)	Internal Size LxWxH (mm)	Overall Size LxWxH (mm)	Unit Weight (kg)
V7540	Double Width Storage Cage (Full Height)	1050	2100x1085x810	2200x1160x1055	125
V7534	Full Height Divider to suit V7540	-	-	1135x750x41	7
V7543	Lid to suit V7540	-	-	1143x1040x60	21
V7542	Wheel Kit to suit V7540	-	-	-	-



## Double Width Storage Cage (Low Height)

- Front and rear gates are removable
- Pallet Rack Safe – unique positive locking base design
- Cage can be collapsed or assembled in seconds
- 4 Way forklift access & pallet truck entry
- Anti-tip base design
- Zinc plated finish
- Optional Half Height Divider sold separately
- Optional Wheel kit sold separately
- Optional Half Height Divider sold separately
- Optional lid sold separately
- Stackable 4 high loaded, and 6 high empty
- Collapsed Height: 320mm



Pictured with V7543 & V7542

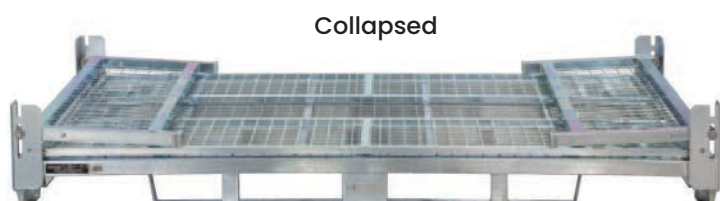

Collapsed



Stacked



Code	Details	Load Capacity (kg)	Internal Size LxWxH (mm)	Overall Size LxWxH (mm)	Unit Weight (kg)
V7539	Double Width Storage Cage (Low Height)	1050	2100x1085x430	2200x1160x660	110
V7538	Half Height Divider to suit V7539	-	-	1125x345x25	4
V7543	Lid to suit V7539	-	-	1143x1040x60	21
V7542	Wheel Kit to suit V7539	-	-	-	-





## Crane Pallet Cage

- The V7565 Crane Pallet Cage is a lightweight, affordable solution for storing and transporting loose goods by crane or forklift.
- Fully opening front gate for easy loading and unloading
- Stacking feet allow cages to be stacked 3 high when empty or 2 high when loaded
- Suitable for storage on pallet racking
- Fitted with 4 point lift crane lugs and forklift pockets
- Sheet metal floor fitted standard
- Zinc finish
- Fork Pocket Size: 245x80mm
- Fork Pocket Centres: 452mm
- Supplied standard as flatpack for on-site assembly or supplied fully assembled (V7565A)



Code	Details	Working Load Limit (kg)	Internal Dimensions LxWxH (mm)	Overall Size LxWxH (mm)	Unit Weight (kg)
V7565	Crane Pallet Cage	1000	1060x1060x900	1250x1250x1100	110
V7565A	Crane Pallet Cage Assembly Available				





# Forklift Safety Cage/Work Platform

- Manufactured to meet relevant Australian Standards
- Zinc plated finish
- Designed to carry 2 persons (250kg max)
- Mesh safety screen
- Toe boards all sides with skid resistant floor plate
- Inward opening, self closing door
- Internal handrail with safety loops to hook safety harness
- Full length fork sleeves
- Castors can be fitted to the bottom of cage for easy manoeuvrability in warehouse or yard
- Fork Pocket Size: 160x60mm
- Fork Pocket Centres: 625mm
- HCG: 550mm
- Supplied as flatpack for easy storage and transport however can be ordered with assembly

NO MORE THAN 2 PERSONS MAY BE LIFTED.  
 WEIGHT OF PLATFORM 134KGS.  
 THE LOAD INCLUDING PERSONNEL & EQUIPMENT SHALL NOT EXCEED 250KG  
 USE ONLY ON INDUSTRIAL TRUCKS HAVING A CAPACITY OF 1800KG (COUNTERBALANCED) OR 1080KG (REACH TRUCK) AS APPROVED.  
 DO NOT USE IN PROXIMITY TO LIVE ELECTRICAL EQUIPMENT.  
 FOR USE ONLY AS APPROVED BY STATE STATUTORY AUTHORITY.



Tool tray supplied as standard



Fork cage flatpacked



Safety Harness

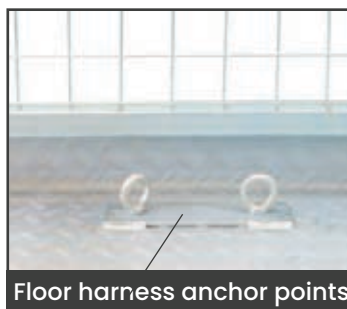

Floor harness anchor points

Code	Details	Internal Floor Dimensions (mm)	Overall Height (mm)	Height to Railing (mm)	Unit Weight (kg)
V4000	Forklift Safety Cage (supplied flatpacked)	1075x1015	2070	1000	124
V4002	Full Body Safety Harness & Lanyard				
V4000A	Forklift Safety Cage Assembly Available				



## Forklift Goods Cage

- Designed for the safe and easy storage and transport of goods including furniture and whitegoods.
- Manufactured in accordance with Australian Standard AS 2359.1 and is ideal for transportation of goods between ground and mezzanine levels.
- Hinged front ramp allows for trolley access
- Goods secured by locking ramp in the vertical position and attaching two safety chains
- Zinc sides with enamel paint finish on base
- Load Centre: 600mm



Safety Chains



Code	Details	Working Load Limit (kg)	Fork Pocket Centres (mm)	Fork Pocket Size (mm)	Unit Weight (kg)
V4005	Forklift Goods Cage	1500	800	185x85	130
V4005A	Forklift Cage Assembly Available				

**You  
May  
Also  
Like**



Craneable Storage Bin - See page 262



## Forklift Ramped Goods Platform

- Allows safe loading and transport of bulky goods, equipment & machinery
- Ramp access for ease of loading & unloading
- Fork pockets fitted for transport and placement of skid by forklift
- 4 flip-up lashing points to safely secure various load sizes
- Kick plates help prevent objects from falling off the platform
- Steel frame and safety chains for added load safety during transport
- Non-slip tread plate floor and ramp
- Reinforced underside to eliminate steel fatigue
- Enamel paint finish
- Fork Pocket Centres: 660mm



Code	Working Load Limit (kg)	Platform Size (mm)	Overall Dimensions LxWxH (mm)	Fork Pocket Size (mm)	Fork Pocket Centres (mm)	Unit Weight (kg)
V4006	2000	1800x1385	2115x1500x1110	170x60	660	310

## Forklift / Crane Transport Platform (with Folding Ramp)

- 600mm fold-up ramp allows for easy loading
- Ramp secured by chain and snap hooks on either side
- 4 point lift lugs and 3-way fork pockets for easy transport and placement of skid
- Multiple tie down points allow various load sizes to be safely secured
- Raised side plates prevent machinery from sliding off the side of skid
- Tread plate floor and ramp for traction
- Reinforced underside to eliminate steel fatigue
- Recessed base to suit storage in standard pallet racking
- Zinc finish



Code	Working Load Limit (kg)	Platform Size (mm)	Overall Dimensions LxWxH (mm)	Fork Pocket Size (mm)	Fork Pocket Centres (mm)	Unit Weight (kg)
V4035	1000	2000x1150	2610x1175x230	140x65	550	180





# Heavy Duty Steel Longspan Shelving (450 & 600mm Deep)

- This heavy duty longspan shelving system is a strong and versatile shelving system, which is similar to pallet racking just in a similar profile, which is great for storing small parts and archives.
- This system is supplied standard with 3 adjustable shelves however extra shelf levels can be ordered for each set
- Comes standard with steel shelves (2 pieces per level)
- End frames are supplied assembled for quick and easy setup
- Standard longspan 450mm and 600mm deep stock sizes are listed below
- Step beams which the steel decks sit flush with the beam
- Shelf Capacity: 390kg/level - 1800(L) Beam, 290kg/level - 2400(L) Beam
- For overall bay length add 60mm per frame



Watch a video of this in operation on our website here: [www.verdex.com.au/V8000](http://www.verdex.com.au/V8000)



Height (mm)	Width (mm)	Depth (mm)	Starter Bay Code	Add On Bay Code	Extra Shelf Level Code
1800	1800	450	V8000	V8001	V8008
1800	1800	600	V8002	V8003	V8009
2400	1800	450	V8004	V8005	V8008
2400	1800	600	V8006	V8007	V8009
1800	2400	450	V8015	V8016	V8023
1800	2400	600	V8017	V8018	V8024
2400	2400	450	V8019	V8020	V8023
2400	2400	600	V8021	V8022	V8024

V7326 Castor Kit to suit Longspan Shelving (includes 4 castors with brakes)



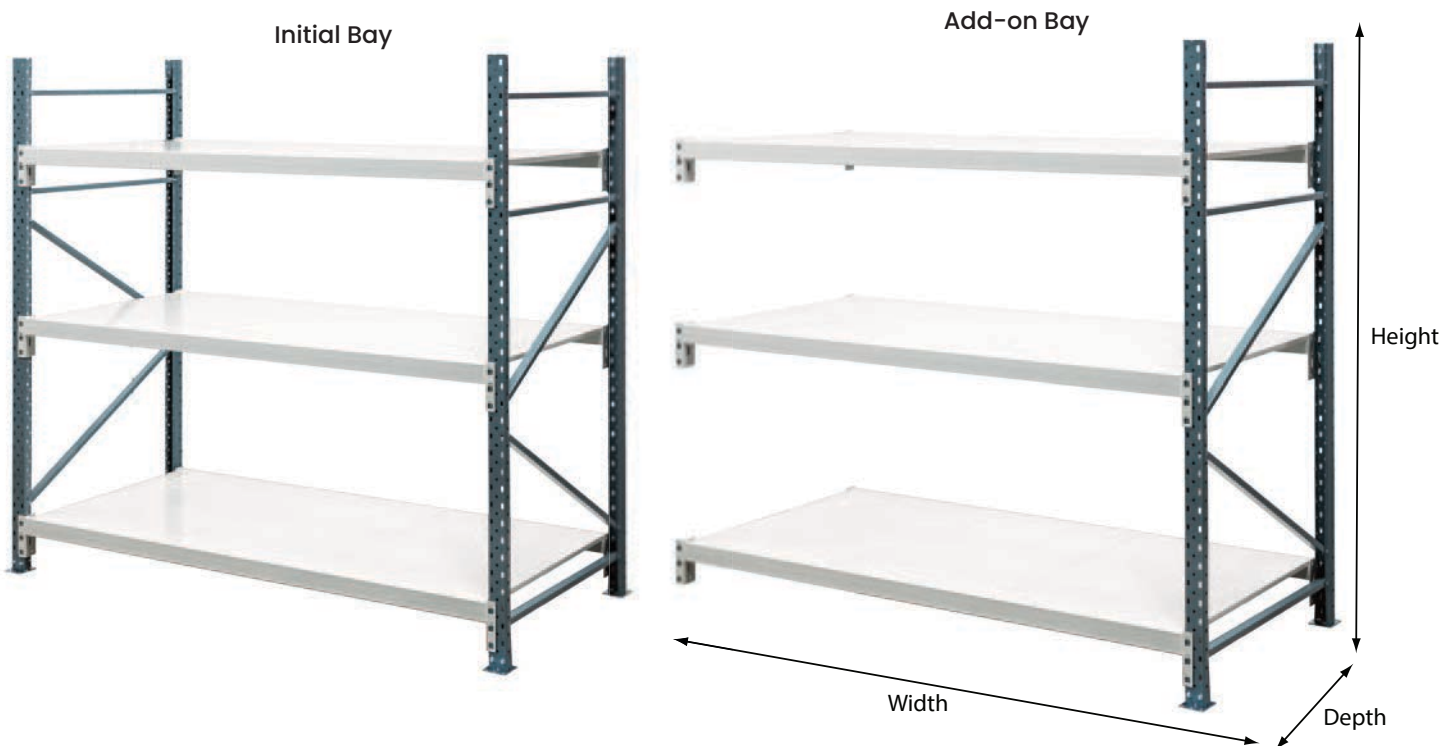

# Heavy Duty Steel Longspan Shelving (900mm Deep)

- This heavy duty longspan shelving system is a strong and versatile shelving system, which is similar to pallet racking just in a similar profile, which is great for storing small parts and archives.
- This system is supplied standard with 3 adjustable shelves however extra shelf levels can be ordered for each set
- Comes standard with steel shelves (2 pieces per level)
- End frames are supplied assembled for quick and easy setup
- Standard longspan 900mm deep stock size is listed below
- Step beams which the steel decks sit flush with the beam
- Shelf Capacity: 390kg/level - 1800(L) Beam, 290kg/level - 2400(L) Beam
- For overall bay length add 60mm per frame



Watch a video of this in operation on our website here: [www.verdex.com.au/V8410](http://www.verdex.com.au/V8410)

Height (mm)	Width (mm)	Depth (mm)	Starter Bay Code	Add On Bay Code	Extra Shelf Level Code
1800	1800	900	V8410	V8411	V8418
2400	1800	900	V8412	V8413	V8419
1800	2400	900	V8414	V8415	V8418
2400	2400	900	V8416	V8417	V8419

V7326 Castor Kit to suit Longspan Shelving (includes 4 castors with brakes)



# Heavy Duty Longspan Shelving (with Mesh Shelves)

- This heavy duty longspan shelving system is a strong and versatile shelving system, which is similar to pallet racking just in a similar profile, which is great for storing small parts and archives.
- This system is supplied standard with 3 adjustable shelves however extra shelf levels can be ordered for each set
- Comes standard with mesh shelves (2 pieces per level)
- End frames are supplied assembled for quick and easy setup
- Standard longspan 450mm and 600mm deep stock sizes are listed below however other configurations can be ordered on request
- Step beams which the mesh decks sit flush with the beam
- Shelf Capacity: 390kg/level - 1800(L) Beam, 290kg/level - 2400(L) Beam
- For overall bay length add 60mm per frame

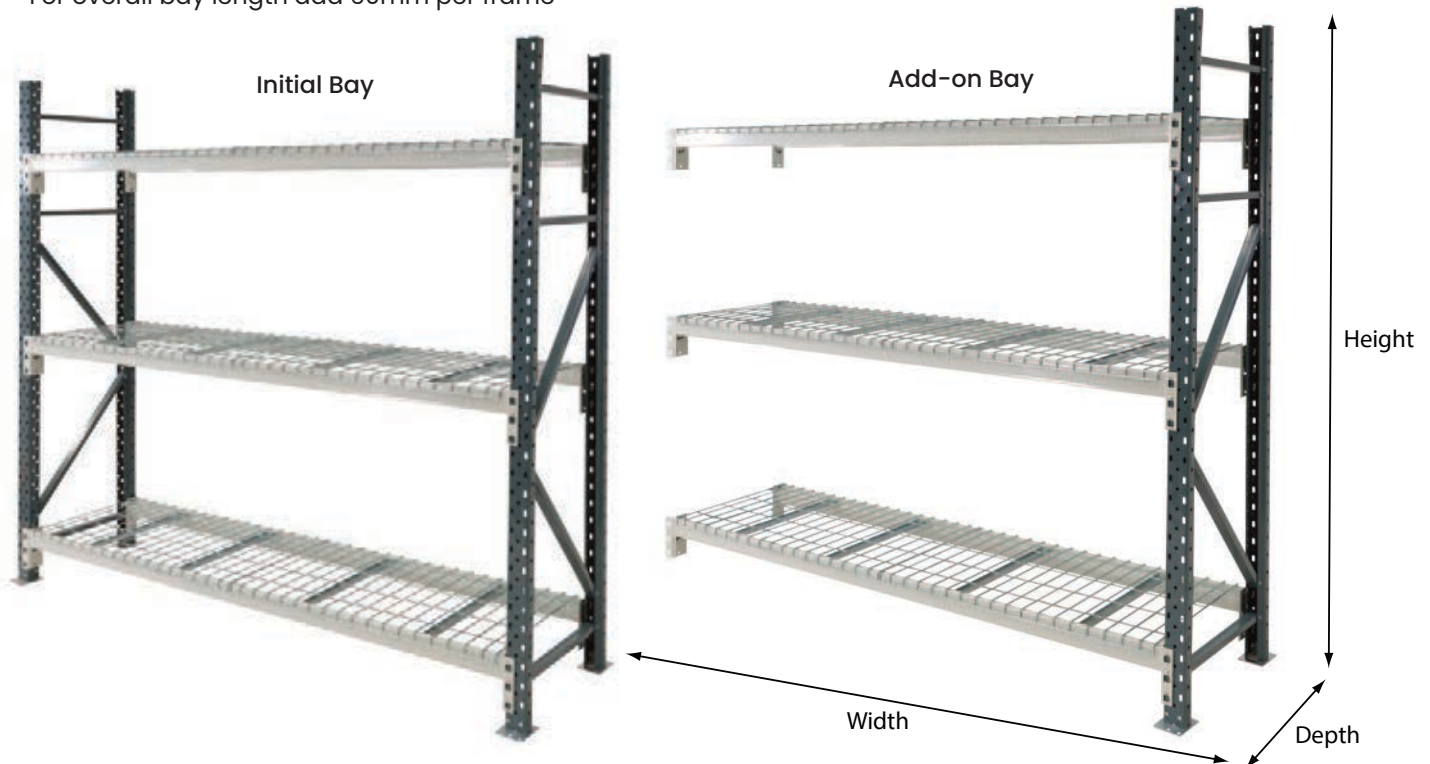

Height (mm)	Width (mm)	Depth (mm)	Starter Bay Code	Add On Bay Code	Extra Shelf Levels
1800	1800	450	V8030	V8031	V8038
1800	1800	600	V8032	V8033	V8039
2400	1800	450	V8034	V8035	V8038
2400	1800	600	V8036	V8037	V8039
1800	2400	450	V8045	V8046	V8053
1800	2400	600	V8047	V8048	V8054
2400	2400	450	V8049	V8050	V8053
2400	2400	600	V8051	V8052	V8054

V7326 Castor Kit to suit Longspan Shelving (includes 4 castors with brakes)





# Pallet Straighteners

- Pallet Straighteners are beneficial tools in warehouse settings, as they help maintain efficiency, safety and organization.
- Designed to help maximise storage capacity and prevent accidents by securing the load, ensuring the pallets are properly positioned
- Steel construction
- Powder coated, blue finish



V1490



V1495



V1496



V1496 pictured with Steel Pallets



V1495 pictured with Timber Pallets

Code	Details	Overall Size LxWxH (mm)	Unit Weight (kg)
V1490	Pallet Straightener (10 pallets)	1910x2000x1505	315
V1495	Pallet Straightener (15 pallets)	1910x2000x2255	410
V1496	Pallet Straightener (20 pallets)	1910x2000x3010	490

## Pallet Racking End Protectors

Pallet Racking End Protectors are a highly effective solution for preventing damage to racking and inventory by forklifts.

No matter how good your forklift drivers are, there will always be sometime when an accident or mistake happens when they crash into the pallet racking. You can avoid major injuries and pallet rack damage by installing these protection guards.

Damage and failure not only cause serious safety issues but disassembling, repair, reassembling and reloading of pallet racks add significantly to running costs.

- Single Bay End Protector to suit 838mm frame
- Double Bay End Protector to suit 838mm frame + 430mm space + 838mm frame
- Conforms to relevant Australian Standards

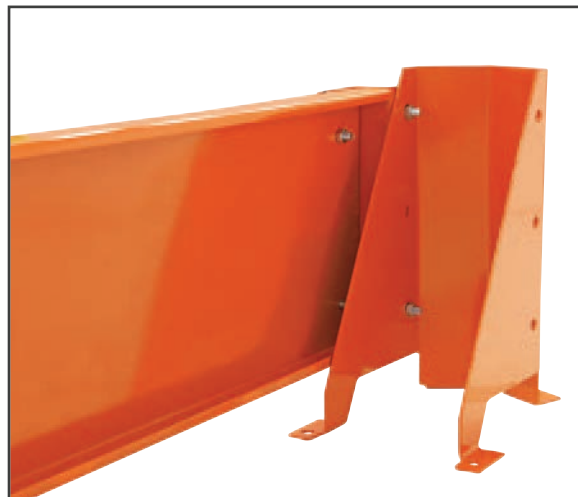

V7405



V7406

Code	Description	Height (mm)	Overall Length (mm)	Unit Weight (kg)
V7405	Racking End Protector (to suit single bay of racking)	400	1080	15
V7406	Racking End Protector (to suit double bay of racking)	400	2350	27



## Pallet Racking Mesh Decks

- Our mesh decks are made to suit almost any standard pallet racking system
- Other sizes can be made to order
- Comes complete with support bars
- 2 pieces per beam
- Suitable for skids & pallets of heavier weights
- Galvanised finish

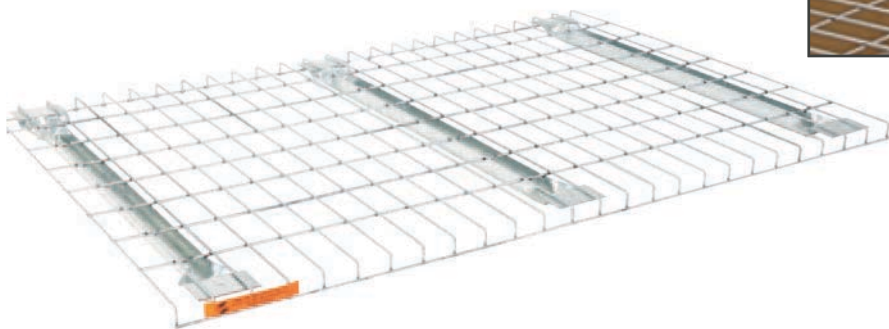

Code	Details	Load Capacity (kg)	Width (mm)	Depth (mm)	Unit Weight (kg)
V7462	Pallet Racking Mesh Decks (suits 2600mm beams)	1000	1250	840	10.6
V7463	Pallet Racking Mesh Decks (suits 2750mm beams)	1000	1350	840	11.6

## Pallet Racking Column Guards

- Pallet Racking Column Guards are a highly effective solution for preventing damage to racking and inventory by forklifts.
- No matter how good your forklift drivers are, there will always be sometime when an accident or mistake happens when they crash into the pallet racking.
- You can avoid major injuries and pallet rack damage by installing these protection guards.
- Damage and failure not only causes serious safety issues but disassembling, repair, reassembling and reloading of pallet racks add significantly to running costs.
- Conforms to relevant Australian Standards



Top View



Code	Overall Size HxD (mm)	Unit Weight (kg)
V7400	400x220	5





## Rolling Metal Step Stool

- This rolling step stool is the most popular in our range
- Spring loaded castors for rolling which spring upwards when you step on the stool
- Non-Slip rubber surface on both steps
- Powder coated steel construction
- Castors: 30mm



Code	Load Capacity (kg)	Top Step Dia. (mm)	Bottom Step Dia. (mm)	Bottom Step Height (mm)	Base Dia. (mm)	Height to Top Step (mm)	Unit Weight (kg)
V4100	150	290	330	225	435	430	4.5

## General Purpose Plastic Step Stool

- Ideal for offices, libraries, and archive areas
- Strong plastic construction with non-slip steps
- Anti-skid rubber feet



Code	Load Capacity (kg)	Platform Size (mm)	Height (mm)	Overall Size LxWxH (mm)	Unit Weight (kg)
V4101	175	390x390	370	510x510x265	3.3

## All Purpose Step Ladders

- Compact Folding Design
- Anti-Slip Treads
- Made From Highly Durable Steel
- Capacity: 120kg



Code	Description	Ladder Open Height (mm)	Platform Height (mm)	Unit Weight (kg)
V4140	All Purpose Step Ladder (2 Steps)	1100	450	6
V4141	All Purpose Step Ladder (3 Steps)	1250	680	8



## Fibreglass Industrial Platform Ladders

- Available in 3 platform heights: 900mm, 1200mm and 1500mm
- Large anti-skid work platform with raised edges - keeps feet in side the platform for greater safety and comfort
- One piece, smooth operation - simply folds out and locks
- Platform size: 600x600mm
- Rated to 150kgs
- Complies to AS/NZS 1892:1998



V4210

V4211

V4212



V4230 Safety Gate Kit



Anti-skid platform



V4220 Castor Kit

Code	Details	No. of Steps	Platform Height (mm)	Unit Weight (kg)
V4210	Fibreglass Platform Ladder (1800mm high)	3	900	13
V4211	Fibreglass Platform Ladder (2100mm high)	4	1200	15
V4212	Fibreglass Platform Ladder (2400mm high)	5	1500	17
V4220	Platform Ladder Castor Kit to suit Fibreglass Platform Ladders			
V4230	Platform Ladder Safety Gate Kit to suit Fibreglass Platform Ladders			

## Verdex Access Platform Ladders

These Access Platform Ladders are designed for safe, easy and efficient use in warehousing, vehicle maintenance, mining, aviation and heavy industry workplaces.

- Access Platform 2-In-1 With Bonus Work Shelf
- Super strong 'fully welded' design fabricated from heavy duty aluminium
- Steel bracing under bottom tread and side bracing provides additional protection from impact damage
- 100mm deep treads improve safety and comfort when climbing
- Suited to 'high frequency' use
- Walk-thru' design for stock picking and access to mezzanine floors, vehicle access and warehousing
- Large 125mm wheels – improved portability and 'easy glide' action
- Large stable work platform (safe and stable) – 600mm x 710mm
- Manually operated braking system with high-vis powder coated activation arm helps minimize unauthorised access
- Two safety gates fitted (a 2 in 1 product allowing for walk-thru access)
- Toeboard on three sides (helps secure tools/accessories)
- Made to AS/NZS 1892.1
- 200kg load rating
- Handrail Height: 1000mm
- Industrial duty rating for use on commercial sites
- Meets Work Cover requirements (safety gate + 900mm handrail, toeboard)
- Supplied as a 'flat pack' for optimal transporting however can be assembled on request

8 Step Access Platform Ladder







V4150



V4151



V4152



V4153



V4154



V4155



Watch a video of this in operation on our website here:

[www.verdex.com.au/V4150](http://www.verdex.com.au/V4150)



Code	Details	Platform Height (mm)	Reach Height (m)	Open Size LxWxH (mm)	Unit Weight (kg)
V4150	Access Platform Ladder - 3 Step	792	2.8	1315x797x1677	35
V4151	Access Platform Ladder - 4 Step	1056	3.1	1321x821x1941	38
V4152	Access Platform Ladder - 5 Step	1320	3.3	1489x862x2205	41
V4153	Access Platform Ladder - 6 Step	1584	3.6	1655x905x2469	44
V4154	Access Platform Ladder - 7 Step	1848	3.9	1826x747x2773	47
V4155	Access Platform Ladder - 8 Step	2112	4.1	1993x989x2997	51



## 6 Tonne Capacity 1 Piece Container Ramp

This container ramp is a great general purpose ramp for unloading containers using pallet trucks or forklifts. This is a one piece unit with forklift slots at the front for easy transport. Finished in painted yellow and supplied with chain & D Shackle, the 6 Tonne container ramp is ready for immediate delivery.

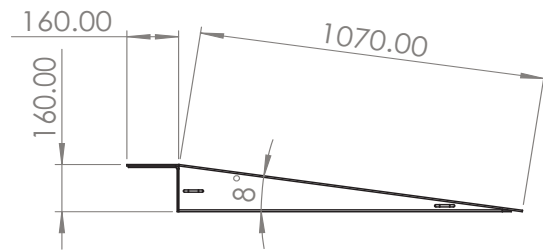
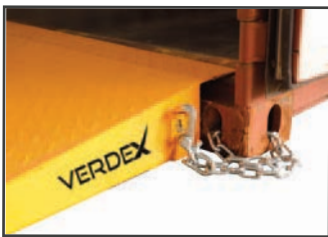
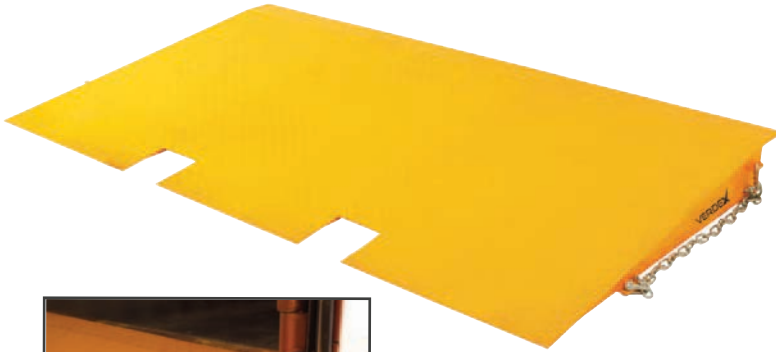

Code	Load Capacity (kg)	Width (mm)	Height (mm)	Length (mm)	Unit Weight (kg)
V4010	6000	2200	160	1200	180

## 8 Tonne Capacity 1 Piece Container Ramp

This container ramp is a great general purpose ramp for unloading containers using pallet trucks or forklifts. This is a one piece unit with forklift slots at the front and side for easy transport. Finished in painted yellow and supplied with chain & D Shackle, the 8 Tonne container ramp is ready for immediate delivery.

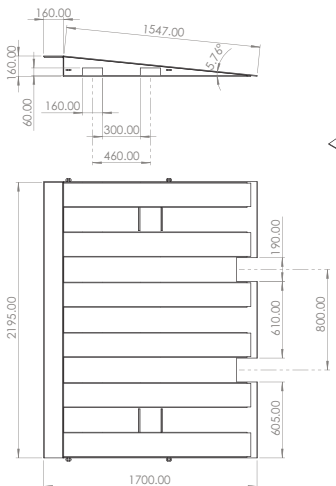

Code	Load Capacity (kg)	Width (mm)	Height (mm)	Length (mm)	Side Fork Pocket Size (mm)	Unit Weight (kg)
V4015	8000	2200	160	1720	80x165	270



# 7 Tonne Capacity Container Ramp

This container ramp is designed primarily for bridging into a standard container from ground level that is slightly uneven due to its self-levelling lip. The ramp footing fold has handles which you can easily fold back to move the ramp using the fork slots. Finished in painted yellow and supplied with chain & D shackle, the 7 Tonne container ramp is ready for immediate delivery.

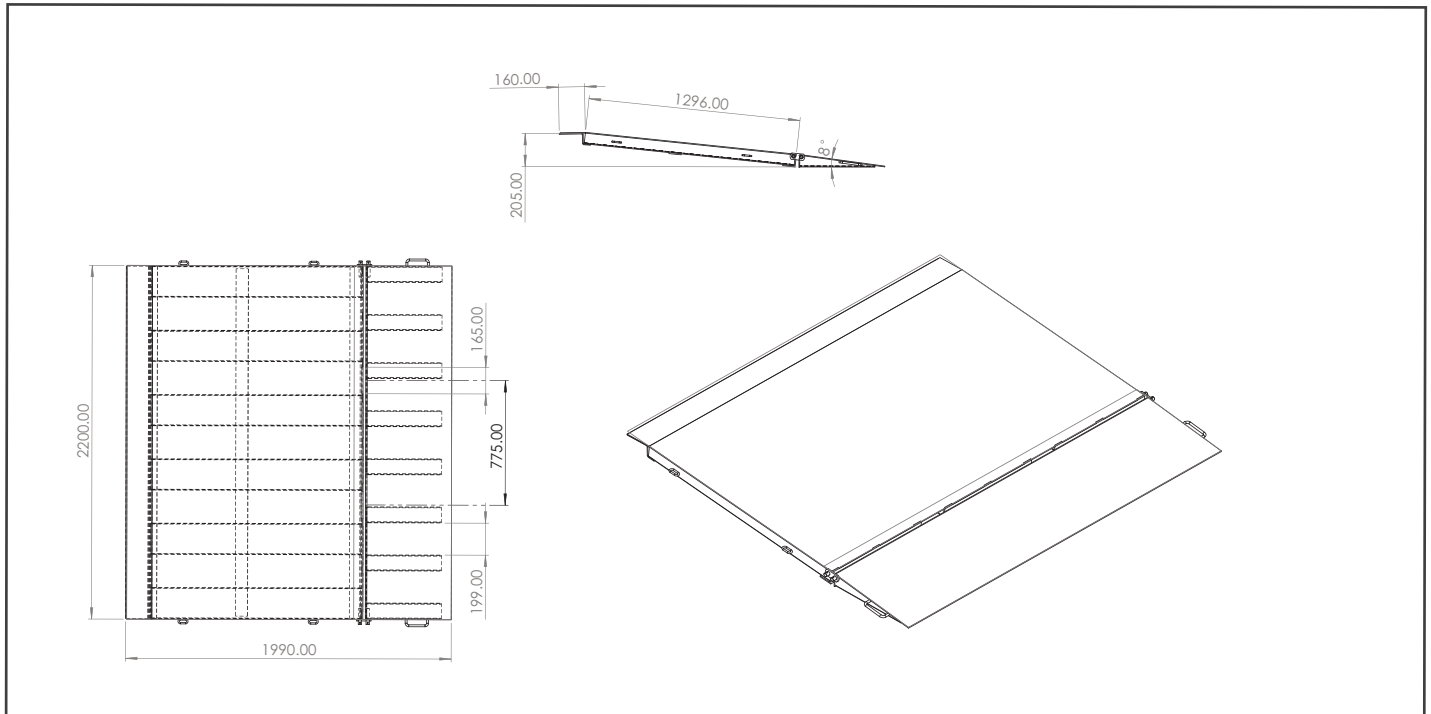

Watch a video of this in operation on our website here: [www.verdex.com.au/V4020](http://www.verdex.com.au/V4020)



Code	Load Capacity (kg)	Width (mm)	Length (mm)	Fork Pocket Centres (mm)	Fork Pocket Size (mm)	Unit Weight (kg)
V4020	7000	2200	2000	775	165x60	275





## 10 Tonne Heavy Duty Container Ramp

The V4025 container ramp is a heavy duty ramp for unloading containers of heavy products with a large forklift. This ramp has been designed for fast positioning and removal with tine pockets on the side plus pop up tine slots in the top for front removal. The ramp has an enamel painted finish. Comes standard with 100mm raised side plates which ensure the forklift remains on the ramp.

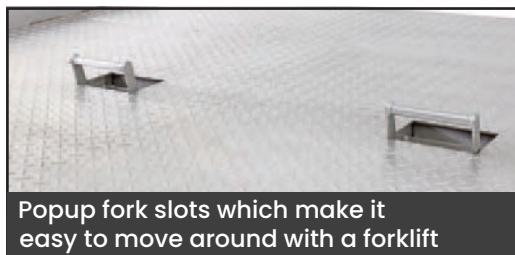
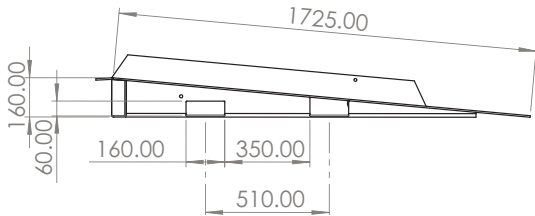

Popup fork slots which make it easy to move around with a forklift

Code	Load Capacity (kg)	Width (mm)	Length (mm)	Fork Pocket Size (mm)	Fork Pocket Centres (mm)	Unit Weight (kg)
V4025	10,000	2320	1800	160x60	510	410

## 10 Tonne Heavy Duty Container Ramp (Extra Long)

The V4030 extra long container ramp has an overall length of 3 metres. This ramp has been designed for fast positioning and removal with tine pockets on the side plus pop up tine slots in the top for front removal. The ramp has an enamel painted finish. Comes standard with 100mm raised side plates which ensure the forklift remains on the ramp.

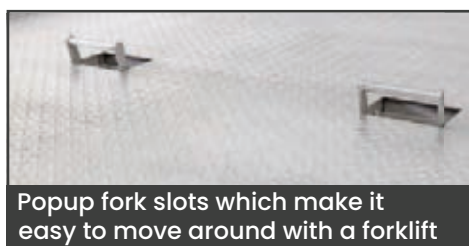
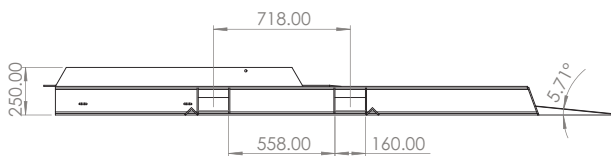

Popup fork slots which make it easy to move around with a forklift

Code	Load Capacity (kg)	Width (mm)	Overall Height (mm)	Length (mm)	Top Fork Pocket Centres (mm)	Unit Weight (kg)
V4030	10,000	2320	250	3000	718	600



# Mobile Loading Dock/Container Ramp

- Features a large deck for entry between truck and trailer
- Quick setup to minimise wasted time
- Designed specifically for rough applications
- Maintenance-free design eliminates downtime
- Towing / Maneuvering; the ramp has fork pockets at the lower end for a forklift to enter and push into position
- Safety chain for the securing ramp to the trailer
- Galvanized reinforced metal grate, making it ideal in slippery weather conditions
- Constructed from strong materials allowing it to be used frequently
- Two solid filled tires fitted to assist with ramp relocation
- Front Lip Length: 700mm
- Rear Lip Width: 2000mm
- Front Lip Width: 950mm
- Min / Max Height: 1060/1650mm



Watch a video of this in operation on our website here: [www.verdex.com.au/v4040](http://www.verdex.com.au/v4040)



Code	Load Capacity (kg)	Ramp Length (mm)	Ramp Width (mm)	Ascent Length (mm)	Straight Length (mm)	Unit Weight (kg)
V4040	8000	10500	2150	5000	2500	2650





## Galvanised Concrete Collection Tray

- The Galvanised Concrete Collection Tray is designed to limit environmental damage wherever a concrete pump is being used on site.
- This low profile tray fits under the concrete pump to collect spillage washout water and concrete waste.
- Fitted with 4-way fork pockets and four crane lifting and up-ending lugs and is manufactured with tapered sides.
- Capacity: 0.85 cu. m
- Galvanised Finish



Code	SWL (kg)	Overall Size LxWxH (mm)	Fork Pocket Size (mm)	Fork Pocket Centres (mm)	Unit Weight (kg)
V6211	1500	2070x1765x400	160x75/160x95	870	215

## Concrete Collection Tray

- The Concrete Collection Trays are designed to limit environmental damage wherever a concrete pump is being used on site.
- This low profile tray fits under the concrete pump to collect spillage washout water and concrete waste.
- Low profile tray with tapered sides
- Reinforced base and sides
- Fitted with crane lifting and up-ending lugs
- 4-way fork pockets allowing access from all sides
- Optional disposable plastic liner available
- Enamel paint finish
- Fork Pocket Centres: 880mm



V6210



V6212

Code	Details	SWL (kg)	Overall Size LxWxH (mm)	Fork Pocket Size (mm)	Unit Weight (kg)
V6210	Concrete Collection Tray (0.5 cubic metres)	1000	1860x1560x360	170x85	150
V6212	Disposable Plastic Liner to suit V6210				





# Concrete Block Moulds

- The Concrete Moulds' simple construction and portable design make it the perfect solution for recycling leftover concrete on-site.
- Simple construction is fast to assemble
- Lightweight & stackable design is easy to transfer between sites
- Concrete blocks can be used as temporary foundation blocks, retaining walls, security blocks and anchor blocks for boat moorings
- Provision for cast in ferrule (suits 12mm reinforcing bar)
- Supplied with a single M20 eyebolt and ferrule
- Half mould insert available for smaller blocks to be used in retaining wall applications
- Enamel paint finish
- Finished Block Dimensions: 1200x600x600mm



Watch a video of this in operation on our website here: [www.verdex.com.au/V6200](http://www.verdex.com.au/V6200)



V6200



V6201 - Half Mould Insert



V6206 - M20 Eyebolt

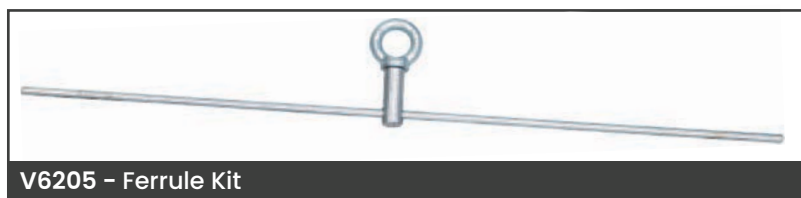

V6205 - Ferrule Kit

Code	Description	Finished Block Dimensions (mm)	Overall Dimensions (mm)	Unit Weight (kg)
V6200	Concrete Block Mould (0.432cu.m capacity)	1200x600x600	1356x756x600	178
V6201	Half Mould Insert to suit V6200			
V6205	Ferrule Kit - Includes Ferrule & 1m Reo Bar & M20 Eyebolt			
V6206	M20 Eyebolt			



## Concrete Kibble

The unit is lever operated from either side for easy flexible operation and heightened user control. Easily transport around a working environment or job site with it's included forklift pockets. This accessory helps facilitate safe and manageable pouring of concrete with an enamel painted finish in blue.

- Painted blue enamel
- Safe Working Load (SWL) 3000kg
- Volume Capacity 1.0 cubic metres



V6230



Concrete Funnel attached to V6226

Code	Description	Overall Dimensions LxWxH (mm)	Fork Pocket Size (mm)	Fork Pocket Centres (mm)	Unit Weight (kg)
V6226	Concrete Kibble (1 CBM)	1760x1655x1705	165x65	870	320
V6230	Concrete Funnel to suit Kibble				





# Bulk Bag Filling Frame

This frame is designed to safely hook open a bulk bag and fill with free-flowing bulk products such as sand and gravel, removing the need for the operator to hold the bag open or manually fill themselves.

- 4 safety swivel hooks hold bulk bag in position whilst filling
- Adjustable bag restraining chains position bulk bag at correct height
- 3 adjustable height settings to suit your operational requirements
- Fork pockets fitted for easy transport
- Optional clamshell gate for control over flow rate
- Optional spill guard prevents overspill
- Upper hopper assembly enamel paint finish. Support frame zinc finish
- Fork Pocket Size: 140x65mm
- Fork Pocket Centres: 850mm



V6222 - Optional Spill Guard



V6221 - Optional Clamshell Gate

Code	Description	Overall Dimensions (mm)	Hopper Opening (mm)	Unit Weight (kg)
V6220	Bulk Bag Filling Frame	1800x1150	554x400	270
V6221	Optional Clamshell Gate			
V6222	Optional Spill Guard			





## A-Frame Rigging Racks

The A-Frame Rigging Storage Rack is the ideal solution to manage and store rigging equipment such as chains, slings, shackles, hooks and clamps when not in use.

- Hanging hooks store and organise your rigging equipment
- Solid base keeps your rigging equipment off the floor
- Strong 'A' frame construction provides stability
- Fork pockets and crane lugs fitted for transport by forklift or crane
- Wheels fitted (removable) for complete manoeuvrability
- Suits storage of rigging equipment at industrial facilities
- Storage trays are available as an optional extra
- Supplied flatpack for transport
- Enamel paint finish with zinc finish lid



V7577 - Optional Storage Tray



V7575



V7576

Code	Details	Overall Dimensions LxWxH (mm)	Fork Pocket Size (mm)	Fork Pocket Centres (mm)	Unit Weight (kg)
V7575	A-Frame Rigging Rack - 1250mm	1250x1150x2045	140x90	450	110
V7576	A-Frame Rigging Rack - 2000mm	2000x1150x2045	140x90	750	130
V7577	Rigging Storage Rack Tray	570x1150x150	-	-	18



## Boot Cleaning Brush & Grate

- Designed to accommodate cleaning one shoe at a time
- Metal grate for scraping off hard stuck on debris
- Reduces cleaning costs by stopping dirt from being walked inside
- Heavy duty metal construction is built tough to last
- Suits mining, construction, recycling, agriculture or any industry where dirt is a problem
- 3 brushes with coarse bristles
- Comes standard with 4 x M12 mounting holes
- Hot Dipped Galvanised



Code	Overall Dimensions WxDxH (mm)	Unit Weight (kg)
V6420	600x490x1000	19

## Rigging Hanging Rack

The Rigging Hanging Rack is the ideal solution to manage and store rigging equipment such as chains, slings, shackles, hooks and clamps when not in use.

- Heavy duty construction hook plate
- 5 hooks to store and organise your rigging equipment
- 16mm diameter hooks for optimal strength and capacity
- 4 x 8mm drill holes for securely mounting to a wall
- Suits storage of rigging equipment at industrial facilities
- Enamel paint finish



Code	Hook Diameter (mm)	Hook Centres (mm)	Overall Dimensions WxDxH (mm)	Unit Weight (kg)
V7603	16mm	150	930x100x220	5

## Site Tool Cabinets

- These Site Tool Cabinets are designed as a secure storage solution on work sites that can be transported by overhead crane and forklift.
- Heavy duty construction
- Fitted with crane lugs and fork pockets for easy relocation
- Adjustable shelves allowing flexible storage options
- Dual locking mechanism door provide added security against theft
- Designed & certified in accordance with Australian Standards
- Wheels fitted (removable)
- Powder coated finish
- Features a dust and weatherproof seal
- Working Load Limit (WLL): 1000kg
- Load Centre: 350mm
- HCG: 376mm



V7570

V7571



Adjustable Shelves



Weather proof seal



Fork Pockets

Code	Details	Opening WxH (mm)	Overall Dimensions WxDxH (mm)	Fork Pocket Size (mm)	Fork Pocket Centres (mm)	Unit Weight (kg)
V7570	Site Tool Cabinet - Single Door	1055x1055	1155x700x1450	166x67	660	180
V7571	Site Tool Cabinet - Double Door	1250x1405	1350x800x1815	166x67	762	260





# Site Tool Box

The Single Site Tool Box is designed as a secure storage solution on work sites that can be transported by overhead crane and forklift.

- Heavy duty, weather proof construction
- Fitted with crane lugs and fork pockets for easy relocation
- Tamper proof, lockable door provides security against theft
- Gas strut fitted for easy opening
- Wheels fitted (removable)
- Fully engineered in Australia in accordance with Australian Standards
- Enamel paint finish



Crane Lifting Lugs



Fork Pockets



Weather proof seal



Code	Working Load Limit (kg)	Opening WxH (mm)	Inside Clearance WxDxH (mm)	Fork Pocket Size (mm)	Fork Pocket Centres (mm)	Unit Weight (kg)
V7572	1000	1055x1055	955x555x600	155x55	646	110

## Scissor Lift Trolleys (Single Scissor)

- These units help take the strain out of loading and unloading items from raised levels.
- The table is elevated by a pump action foot pedal and smoothly lowered by a hand operated release trigger.
- Foot operated hydraulic operation
- Lever release control
- Safety overload bypass valve
- Stepless rate of lowering regardless of load weight
- Durable powder coated finish
- Polyurethane castors - 2 x fixed, 2 x swivel with brakes



Code	Load Capacity (kg)	Castors (mm)	Table Size LxW (mm)	Lifting Range (mm)	Unit Weight (kg)
V2000	150	100	700x450	220-720	46
V2001	300	125	850x500	340-880	77
V2002	500	125	850x500	340-880	81
V2003	750	125	1000x510	420-990	175



## Scissor Lift Trolleys (Double Scissor)

- These units help take the strain out of loading and unloading items from raised levels.
- The table is elevated by a pump action foot pedal and smoothly lowered by a hand operated release trigger.
- Foot operated hydraulic operation
- Lever release control
- Safety overload bypass valve
- Stepless rate of lowering regardless of load weight
- Durable powder coated finish
- Polyurethane castors - 2 x fixed, 2 x swivel with brakes



Code	Load Capacity (kg)	Castors (mm)	Table Size (mm)	Lifting Range (mm)	Unit Weight (kg)
V2010	350	125	910x500	355-1300	105
V2011	500	150	1010x520	435-1585	168
V2012	700	125	1220x610	445-1500	195

## Rough Terrain Scissor Lift Trolley

- Rough terrain scissor lift trolley is ideal for outdoor applications
- Foot Pedal Cycles to Max Height: 25
- Durable powder coated finish
- Rubber castors - 2 x fixed, 2 x swivel with brakes
- Min. Height of Table: 330mm
- Max Lift Height: 1000mm
- Overall Length: 1120mm



Code	Load Capacity (kg)	Castors (mm)	Table Size (mm)	Lifting Range (mm)	Unit Weight (kg)
V2015	200	200	1000x500	340-1010	71



## Electric Scissor Lift Trolleys

- The battery electric scissor lift trolleys are available in both standard lift and high lift versions and 3 load capacities; 300kg, 500kg and 1000kg.
- Smooth lifting of heavy loads with ease
- Automatic 12v charger
- Push button, battery/hydraulic operation
- Polyurethane castors - 2 x fixed, 2 x swivel with brakes



Code	Load Capacity (kg)	Castors (mm)	Table Size (mm)	Lifting Range (mm)	Unit Weight (kg)
V2060	300	125	850x500	290-880	115
V2063	500	150	1010x520	495-1618	198
V2064	1000	150	1200x800	430-1220	225



## Extra Large Scissor Lift Trolleys

- The extra large scissor lift trolleys are excellent for handling large bulky items.
- The table is elevated by a pump action foot pedal and smoothly lowered by a hand operated release trigger.
- Foot operated hydraulic operation
- Lever release control
- Safety overload bypass valve
- Positive braking system on rear wheels
- Durable powder coated finish
- Stepless rate of lowering regardless of load weight
- Available in 500kg and 1000kg load capacities
- V2020: Polyurethane castors- 2 x fixed, 2 x swivel with brakes
- V2021: Nylon castors- 2 x fixed, 2 x swivel with brakes



V2020



V2021

Code	Load Capacity (kg)	Castors (mm)	Table Size (mm)	Lifting Range (mm)	Unit Weight (kg)
V2020	500	125	1600x810	290-915	154
V2021	1000	180	2035x750	360-1360	198

## Aluminium Scissor Lift Trolley

- Extremely lightweight - great for vehicle transport
- Aluminium construction with a painted finish
- Foot operated hydraulic operation
- Lever release control
- Safety overload bypass valve
- Stepless rate of lowering regardless of load weight
- Foldable handle
- Polyurethane castors - 2 x fixed, 2 x swivel with brakes



Code	Load Capacity (kg)	Castors (mm)	Handle Height (mm)	Table Size (mm)	Lifting Range (mm)	Unit Weight (kg)
V2030	100	100	1000	700x450	265-755	24

## Stainless Steel Scissor Lift Trolleys

- These stainless steel scissor lift trolleys are great for use in food, pharmaceutical or hygiene areas.
- Foot operated hydraulic operation
- Lever release control
- Safety overload bypass valve
- Stepless rate of lowering regardless of load weight
- Scissor and pump unit is galvanised
- Stainless Steel Grade 304
- Polyurethane castors - 2 x fixed, 2 x swivel with brakes



Code	Load Capacity (kg)	Castors (mm)	Table Size (mm)	Handle Height (mm)	Lifting Range (mm)	Unit Weight (kg)
V2040	100	100	700x445	1000	250-1220	55
V2041	350	100	830x500	1000	330-1295	78





## Galvanised Scissor Lift Trolley

- Galvanised version which is great for food and medical areas
- Foot operated hydraulic operation
- Lever release control
- Double scissor lift version
- Safety overload bypass valve
- Stepless rate of lowering regardless of load weight
- Polyurethane castors - 2 x fixed, 2 x swivel with brakes



Code	Load Capacity (kg)	Castors (mm)	Table Size (mm)	Lifting Range (mm)	Unit Weight (kg)
V2050	150	100	830x500	435-1430	80

## Spring Scissor Lift Trolleys (With Centre Wheel Kit)

- Self-leveling, fully adjustable, weight sensitive
- Designed to maintain an ideal working height for assembly lines and loading / unloading operations
- Balance achieved by double springs fitted to the shock absorbers
- Simple to operate spring tension adjustment
- Centre wheel kit is ideal for movement in small spaces
- Polyurethane castors - 2 x fixed centre, 4 x swivel with brakes
- Centre Castors: 200mm



V2075



V2076

Code	Details	Load Capacity (kg)	Swivel Castors (mm)	Table Size (mm)	Lifting Range (mm)	Unit Weight (kg)
V2075	Scissor Lift Trolley	300	100	830x500	360-770	65
V2076	Scissor Lift Trolley (X Large)	300	100	1200x500	360-770	82

## Self Propelled Electric Scissor Lift Trolley (With Cage)

- These self propelled lift tables take the effort of having to push heavy items manually as well as having electric operated lift.
- With the centre drive wheel it makes it extremely easy to manoeuvre loads in narrow aisles or tight spaces.
- Comes complete with side cage as pictured which can be easily removed if not required
- 4 x swivel castors with brakes
- 2 x pneumatic centre drive wheels
- Batteries: 2x12V 33Ah
- Curtis Controller: 70A
- Motor (Driving): 400W
- Motor (Lifting): 400W
- Lifting Time: 17 seconds
- Castors: 150mm
- Middle Wheels: 275mm



Code	Load Capacity (kg)	Table Size (mm)	Lifting Range (mm)	Overall Size LxWxH (mm)	Unit Weight (kg)
V2080	400	1000x600	460-940	1240x600x1100	180

## Self Propelled Electric Scissor Lift Trolley (Single Scissor)

- Powered Lift and Drive makes this unit ideal for a wide range of applications, including in hospitals and libraries
- 2 x rear swivel castors with brakes
- 2 x pneumatic drive wheels
- Batteries: 2x12V 33Ah
- Curtis Controller: 70A
- Motor (Driving): 400W
- Motor (Lifting): 400W
- Lifting Time: 17 seconds
- Rear Castors: 150mm
- Front Wheels: 275mm



Code	Load Capacity (kg)	Table Size (mm)	Lifting Range (mm)	Overall Size LxWxH (mm)	Unit Weight (kg)
V2081	400	1000x600	460-900	1240x600x1100	180





## Self Propelled Electric Scissor Lift Trolley (Double Scissor)

- Double Scissor lift is optimal for reaching high spaces with heavy loads
- 2 x rear swivel castors with brake
- 2 x pneumatic drive wheels
- Castors: 150mm
- Batteries: 2x12V 33Ah
- Curtis Controller: 70A
- Motor (Driving): 400W
- Motor (Lifting): 400W
- Lifting Time: 17 seconds
- Lifting Range: 460-1600mm
- Front Wheels: 275mm



Code	Load Capacity (kg)	Table Size (mm)	Overall Size LxWxH (mm)	Unit Weight (kg)
V2082	400	1100x600	1340x660x1100	234



Watch a video of this in operation on our website here: [www.verdex.com.au/V2082](http://www.verdex.com.au/V2082)

## Self Propelled Electric Scissor Lift Trolley with Cage (Double Scissor)

- These self propelled lift tables take the effort of having to push heavy items manually as well as having electric operated lift.
- With the centre drive wheel it makes it extremely easy to manoeuvre loads in narrow aisles or tight spaces.
- Comes complete with side cage as pictured which can be easily removed if not required
- Includes centre wheel unit
- 4 x swivel castors with brake
- 2 x pneumatic centre drive wheels
- Batteries: 2x12V 33Ah
- Curtis Controller: 70A
- Motor (Driving): 400W
- Motor (Lifting): 400W
- Lifting Time: 17 seconds
- Castors: 150mm
- Middle Wheels: 260mm
- Cage Height: 450mm



Code	Load Capacity (kg)	Table Size (mm)	Lifting Range (mm)	Overall Size LxWxH (mm)	Unit Weight (kg)
V2083	400	1000x600	450-1625	1340x600x1055	234





## Super Low Profile Lift Tables

- These lift tables achieve a super low closed height, eliminating the need for a pit installation
- The upper platform is fitted with a safety perimeter to prevent descent on contact with obstructions
- 24v control unit with up/down buttons & emergency stop
- Power supply is AC 415V/50HZ/3phase
- The external power pack is equipped with a relief valve against overloading and a compensated flow valve for controlling lowering speed
- Hose burst safety valve which stops the table lifting incase of a hose breakage

35mm low platform allows easy pallet truck entry



Easy to use controller which sits 900mm off ground level



Code	Load Capacity (kg)	Platform Size WxL (mm)	Lifting Range (mm)	Overall Size LxWxH (mm)	Unit Weight (kg)
V2122	1500	1200x1270	35-800	1850x1850x350	380



# Low Profile Pallet Lift Tables

- Using pallet lift tables elevates pallets to the optimum lift height reducing the risk of repetitive strain injury and increasing productivity.
- Supplied with entry ramp to allow pallet truck entry
- Can be supplied with optional rotator ring
- Tables are specially made for handling pallets, no need for a pit or load ramps
- Upper platform fitted with safety perimeter to prevent descent on contact with obstructions
- 24v control box with UP and DOWN buttons and emergency stop
- External power pack equipped with a relief valve against overloading and a compensating flow valve for controlling lowering speed
- Power Supply: 240v (3 phase 415v available if required)
- Hose burst safety valve to stop the lift table lowering in case of hose breakage
- Removable lifting eyes to facilitate handling and installation of the lift table
- Oil-less bushings on pivot points



Ramp supplied with lift table



Watch a video of this in operation on our website here: [www.verdex.com.au/v2100](http://www.verdex.com.au/v2100)



Code	Load Capacity (kg)	Platform Size LxW (mm)	Lifting Range (mm)	Lifting Time	Unit Weight (kg)
V2100	1000	1450x1140	85-860	20 secs	357
V2101	2000	1600x1200	105-870	20 secs	419



## Electric Scissor Lift Tables

Lift tables can be applied in many work places to increase productivity and safety. Loads can be elevated or lowered to optimum heights at the push of a button.

- Heavy duty design and construction
- High quality European power packs
- Suitable for on floor applications or in floor pit applications
- Self lubricating bushings on pivot points
- Removable lifting eyes to facilitate installation and maintenance
- 240V power supply (3 phase available as an option)
- Upper platform fitted with aluminium safety bar preventing descent on contact with obstructions
- Low volt (24v) control box with up-down buttons.
- Internal power pack equipped with relief valve against overloading and compensated flow valve for controlled lowering speed
- Heavy duty cylinders with drainage system and check valve to stop the lift table lowering in case of hose burst
- Safety clearance between scissors to prevent trapping during operation.
- Push button pendant control with up, down and emergency stop

### Small Platform Electric Scissor Lift Table

Small platform lift tables are ideal for lifting small products in tight spaces

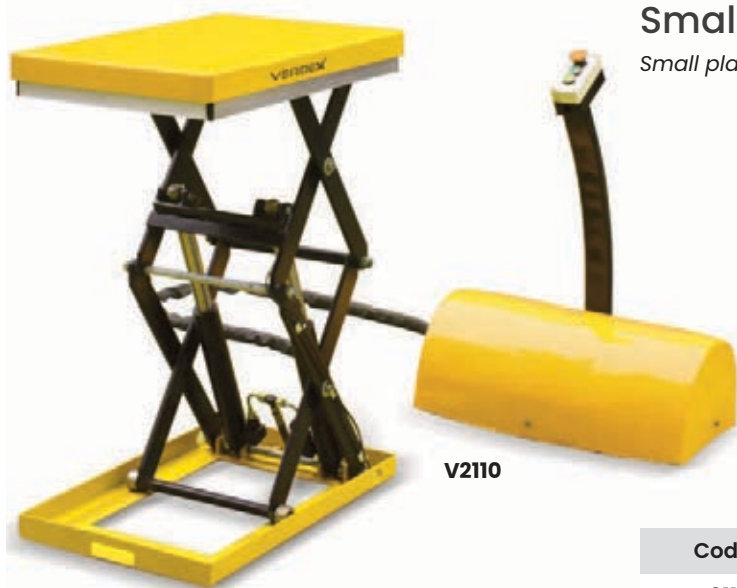

Code	V2110
Capacity	500kg
Table Size	610x910mm (WxL)
Base Frame Size	450x700mm (WxL)
Min Height	162mm
Max Height	950mm
Raise Time	17-22 seconds
Unit Weight	98kg
Power Supply	240 volt

Other custom sizes available - contact us!

Code	Description
V2110	Small Platform Scissor Lift Table (500kg capacity)

### Single Scissor Electric Scissor Lift Tables

Single scissor lift tables for lifting various sized loads.

These tables are ideal for applications where

Code	V2150	V2151
Capacity	2000kg	2000kg
Table Size	850x1300mm (WxL)	1000x2000mm (WxL)
Base Frame Size	785x1255mm (WxL)	785x1630mm (WxL)
Min Height'	230mm	250mm
Max Height	1000mm	1300mm
Raise Time	20-25 seconds	25-30 seconds
Unit Weight	235kg	315kg
Power Supply	240 volt	240 volt

Other custom sizes available - contact us!

Code	Description
V2150	Single Scissor Electric Lift Table
V2151	Single Scissor Electric Lift Table







## Double Scissor Electric Lift Tables

Code	V2165	V2166
Capacity	2000kg	4000kg
Table Size	850x1300mm (WxL)	1200x1720mm (WxL)
Base Frame Size	785x1220mm (WxL)	900x1600mm (WxL)
Min Height	360mm	400mm
Max Height	1780mm	2050mm
Raise Time	35-45 seconds	55-65 seconds
Unit Weight	295kg	520kg
Power Supply	240 volt	240 volt

Other custom sizes available - contact us!

Code	Description
V2165	Double Scissor Electric Lift Table
V2166	Double Scissor Electric Lift Table



## Extra Long Scissor Electric Lift Table

Extra long lift tables are perfect for oversized goods



Code	M2155-16
Capacity	2000kg
Table Size	820x2500mm (WxL)
Base Frame Size	640x2460mm (WxL)
Min Height	205mm
Max Height	1000mm
Raise Time	40-45 seconds
Unit Weight	265kg
Power Supply	3 Phase 415 volt

Other custom sizes available - contact us!

Code	Description
V2155	Extra Long Electric Scissor Lift Table

## High-Lift Electric Scissor Lift Tables

High lift scissor lift tables are ideal for moving goods up levels, including on construction sites and to mezzanines

Code	V2161	V2160
Capacity	2000kg	400kg
Table Size	1000x1700mm (WxL)	1200x1720mm (WxL)
Base Frame Size	1010x1606mm (WxL)	1000x1600mm (WxL)
Min Height	560mm	600mm
Max Height	3000mm	4140mm
Raise Time	70 seconds	30-40 seconds
Unit Weight	750kg	547kg
Power Supply	240 volt	240 volt

Other custom sizes available - contact us!

Code	Description
V2161	High Lift Electric Scissor Lift Table
V2160	High Lift Electric Scissor Lift Table



# Pneumatic Scissor Lift Table

- This pneumatic scissor lift table runs on air with no electrics or hydraulics used – great for pharmaceutical and medical areas as its extremely clean and quite operation
- Safe, clean and extremely low maintenance
- Raise Time: 40-45 seconds
- Air Pressure 263 MPA



V2105 collapsed



Watch a video of this in operation on our website here: [www.verdex.com.au/V2105](http://www.verdex.com.au/V2105)

Code	Load Capacity (kg)	Table Size WxL (mm)	Lifting Range (mm)	Base Frame Size WxL (mm)	Unit Weight (kg)
V2105	1000	812x1220	230-840	784x1220	263

## Optional Accessories for Scissor Lift Tables

As well as the following optional accessories, Verdex has the capability to manufacture custom solutions for your application. Give us a call on 1800 750 500 to discuss!

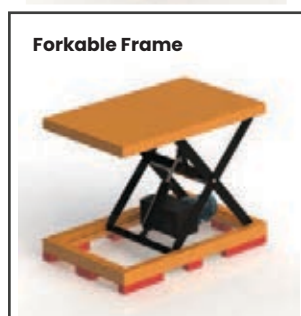
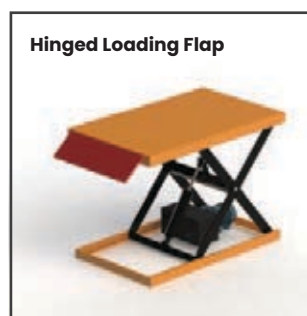
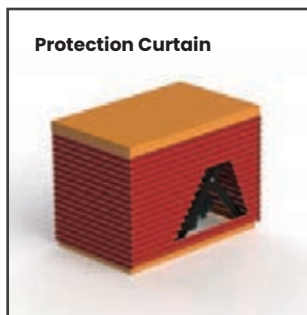





# Bishamon Pneumatic Rotating Pallet Positioner (For Varying Pallet Weights)

The most advanced pallet positioner available!

- EZ Loaders are designed to eliminate worker bending by automatically raising and lowering pallets during loading or unloading without the use of mechanical springs, motors or hydraulics.
- The new EZ loader can now handle a wide range of weight capacities from 110 kilos to 1800 kilos.
- The EZ Adjust knob - a three position knob that allows adjustment of the collapsed capacity without changing the air pressure.
- EZ Loaders also allow easy pallet rotation for near-side loading so the worker does not have to reach or strain.
- As the load weight changes, the EZ Loader automatically adjusts, keeping the top of the load at a convenient working height.
- The patented pneumatic system found only on the EZ Loader has proven to be the choice of industry professionals worldwide.



EZ adjust knob provides up to 550kgs of capacity adjustment with the turn of a knob



Patented self-contained pneumatic system offers unsurpassed performance



Rollers are entrapped in the base frame and platform for added stability



Bellows Skirting (V2172)



Rotator Ring Brake (V2171)



Watch a video of this in operation on our website here: [www.verdex.com.au/V2175](http://www.verdex.com.au/V2175)



Code	Details	Load Capacity (kg)	Rotator Ring Dia. (mm)	Lifting Range (mm)	Base Frame Size (mm)	Unit Weight (kg)
V2175	EZ Loader	110-1800	1092	267-775	1245x617	172
V2171	Rotator Ring Brake					
V2172	Bellows Skirting to suit V2175					





## Spring Loaded Rotating Pallet Tables

- The pallet elevator keeps the active layer of the load at or above waist height, eliminating bending and lifting.
- This pallet elevator can be moved with a standard Pallet Truck
- It is proving highly effective at reducing the incidences of repetitive strain and back injury.
- The construction of the pallet elevator is a scissor type action with varying springs which can be adjusted for different heights
- Turntable allows operator to rotate the load with minimal stretching and reaching.
- No ground fixing required, however the unit is fitted with brackets to allow it to be secured to the ground if required
- Available in Galvanised or Powder Coated finishes
- Fork Pocket Centres: 615mm



**V2134**  
(powder coated model)



**V2135**  
(galvanised model)



PVC Protection screen supplied standard  
Rotating Tops (can be fixed if required)

Springs to suit a wide range of pallet weights

Easy spring changing lock mechanism

Fork pocket centres for easy relocation

Bolt on Brackets



Watch a video of this in operation on our website here:  
[www.verdex.com.au/V2135](http://www.verdex.com.au/V2135)



Code	Details	Load Capacity (kg)	Table Diameter (mm)	Lifting Range (mm)	Fork Pocket Size (mm)	Unit Weight (kg)
V2134	Powder coated	2000	1110	290-750	300x90	195
V2135	Galvanised	2000	1110	290-750	300x90	195



## Rotatable Electric Lift Table

- The pallet elevator is electric up and down via foot pedal and manual rotating top
- It is ideal for varying weight pallets as there is no need to change springs
- Turntable allows the operator to rotate the load with minimal stretching and reaching while controlling the up/down operation via the foot pedal controls
- Can be easily moved around factory with a forklift
- No ground fixing required
- Power: 240V



Foot Pedal to raise and lower platform

Code	Load Capacity (kg)	Lifting Range (mm)	Table Diameter (mm)	Base Frame Size LxW (mm)	Unit Weight (kg)
V2125	2000	300-710	1110	935x915	175

## Powered Rotatable Electric Lift Table

- The pallet elevator is electric up, down and rotating top via pendant control
- It is ideal for varying weight pallets as there is no need to change springs
- Powered Rotation in both directions which can be set to rotate continuously.
- Can be easily moved around factory with a forklift
- No ground fixing required
- Power: 240V



Pendant Control Unit



Watch a video of this in operation on our website here: [www.verdex.com.au/v2126](http://www.verdex.com.au/v2126)



Code	Load Capacity (kg)	Lifting Range (mm)	Table Diameter (mm)	Base Frame Size LxW (mm)	Unit Weight (kg)
V2126	2000	340-710	1110	935x915	190





# Heavy Duty Pallet Stands

- The heavy-Duty steel constructed Pallet Stand keeps the load off the ground limiting the need for bending and lifting.
- This Pallet Stand has accessories tailored for all applications and is proving highly effective at reducing the incidences of repetitive strain and back injury.
- Optional Accessories to suit below
- Steel Construction with a powdercoated finish
- V7908 Height: 250-400mm
- V7909 Height: 500-650mm
- Platform Size: 1250x1250mm
- Optional 100mm Castor Kit: 2 x Fixed, 2 x Swivel with brakes (Adds 160mm Height)



**V7908**  
Heavy Duty Pallet Stand  
(with Short Adjustable Legs)



**V7909**  
Heavy Duty Pallet Stand  
(with Tall Adjustable Legs)

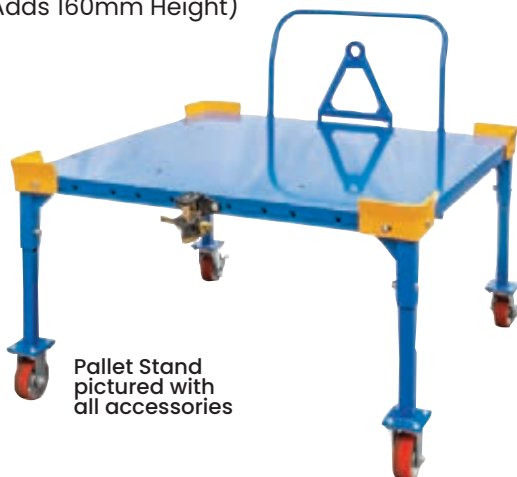

Pallet Stand  
pictured with  
all accessories



V7908 pictured  
with V7903,  
V7905 & V7907

**V7903** Corner Gussets



**V7905** Wheel Kit



**V7906** Adjustable Handle



**V7907** Tow Hitch Kit



**V7904** Steel Cap Base



Code	Description	Capacity (kg)	Unit Weight (kg)
V7908	Heavy Duty Pallet Stand with Short Adjustable Legs	2000	40
V7909	Heavy Duty Pallet Stand with Tall Adjustable Legs	2000	43
V7903	Gussets to suit V7908 & V7909		7.5
V7904	Steel Cap to suit V7908 & V7909		24.5
V7905	Castor Kit to suit V7908 & V7909	2000	11
V7906	Handle to suit V7908 & V7909		4.65
V7907	Tow Hitch Kit to suit V7908 & V7909	4500	7





## IBC Tilting Stand

- The IBC Tilting Stand is designed to keep your IBC at an ergonomic height for decanting
- Designed to prevent the operator from unnecessary strain when operating
- Steel Construction with a powdercoated finish
- V7910 Platform Height: 250-400mm
- V7911 Platform Height: 500-650mm
- Platform Size: 1250x1250mm
- Optional 100mm Castor Kit: 2 x Fixed, 2 x Swivel with brakes (Adds 160mm Height)

See page 271 for our IBC Spring Loaded Tilting Stand



Please Note; IBC Container isn't included



V7904 Steel Cap Base



V7911 with V7905 Castor Kit & V7906 Handle

Code	Description	Capacity (kg)	Unit Weight (kg)
V7910	IBC Tilting Stand with Short Adjustable Legs	2000	145
V7911	IBC Tilting Stand with Tall Adjustable Legs	2000	148
V7904	Steel Cap Base to suit V7910 & V7911		24.5
V7905	Castor Kit to suit V7910 & V7911	2000	11
V7906	Handle to suit V7910 & V7911		4.5

## Heavy Duty Pallet Stand (with Adjustable legs & Turntable)

- The Heavy Duty Pallet Stand with Turntable is designed to rotate pallets, allowing for easier access to goods and materials on your pallet.
- Designed to prevent the operator from unnecessary strain when operating
- Steel Construction with a powdercoated finish
- V7912 Height: 275-425mm
- V7913 Height: 525-675mm
- Platform Size: 1250x1250mm
- Optional 100mm Castor Kit: 2 x Fixed, 2 x Swivel with brakes (Adds 160mm Height)



V7912 with V7905 Castor Kit

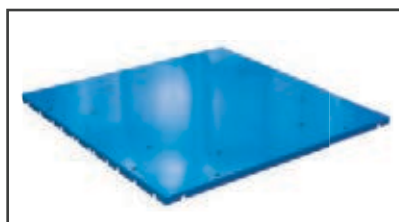

V7904 Steel Cap Base

Code	Description	Capacity (kg)	Unit Weight (kg)
V7912	Pallet Stand with Short Adjustable legs & Turntable	2000	160
V7913	Pallet Stand with Tall Adjustable legs & Turntable	2000	163
V7904	Steel Cap to suit V7912 & V7913		24.5
V7905	Castor Kit to suit V7912 & V7913	2000	11



## Battery Electric Work Positioner

- A range of highly manoeuvrable, lightweight lifts, designed to take the strain out of any lifting job from ground level to over shoulder height
- Ideal for use in narrow aisles and confined spaces. Perfect for all applications from pharmaceutical to catering, from packing line to food processing
- Automatic electric overload protection system ensures safe operation
- Quick change attachment options available
- EN1757 compliant. CE marked
- Battery electric with built in charger that you can plug in anywhere
- Load Centre: 235mm
- 24v, 7.2Ah battery
- 75mm fixed rubber castors on front
- 125mm swivel rubber castors with brakes on rear
- Leg Height: 105mm

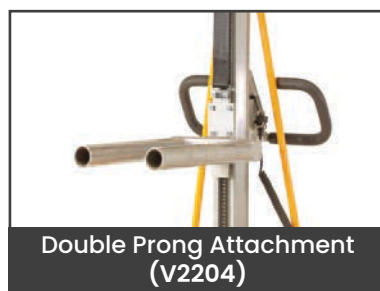

Code	Details	Load Capacity (kg)	Platform/ Attachment Size (mm)	Lifting Range (mm)	Overall Size LxWxH (mm)	Unit Weight (kg)
V2200	Work Positioner	100	470x660	130-1700	890x600x1990	62
V2201	Work Positioner	150	470x660	130-1500	890x600x1790	65
V2202	V Block Attachment - 400x400x80mm					
V2203	Roll Prong Attachment - 600x50mm					
V2204	Double Prong Attachment - 450x50mm (200mm between)					
V2205	Reel Handler Rotator Attachment - 430x90mm					



## Stainless Steel Battery Electric Work Positioner

- These stainless steel lifters are ideal for the food and pharmaceutical industries where hose down is required.
- Automatic electric overload protection system ensures safe operation.
- EN1757 compliant. CE marked
- Battery electric with built in charger that you can plug in anywhere
- Battery: 24V, 12.0Ah
- Power: 24V, 200W
- Compatible with attachments pictured on previous page
- Load Centre: 235mm
- 75mm fixed rubber castors on front
- 125mm swivel rubber castors with brakes on rear
- Leg Height: 115mm
- S/S Grade: 304



Pendant controller  
on flexi cord



Control Unit

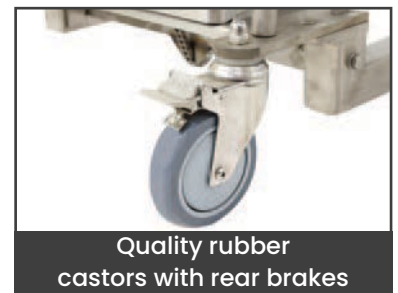

Quality rubber  
castors with rear brakes

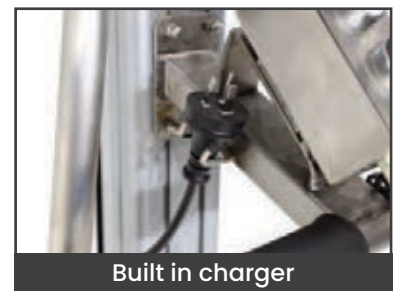

Built in charger

Code	Load Capacity (kg)	Platform/ Attachment Size(mm)	Lifting Range (mm)	Overall Size LxWxH (mm)	Unit Weight (kg)
V2210	100	470x600	150-1760	890x600x1990	63
V2211	150	470x600	130-1560	890x600x1790	66



## Battery Electric Platform Work Positioners

- A range of highly manoeuvrable, lightweight lifts, designed to take the strain out of any lifting job from ground level to over shoulder height
- Ideal for use in narrow aisles and confined spaces.
- Perfect for all applications from pharmaceutical to catering, from packing line to food processing
- Automatic electric overload protection system ensures safe operation
- Load Centre: 237mm
- Platform/ Attachment Size: 475x605mm
- Lifting/Lowering Speed: 55mm/s
- Steering Wheel: 100mm
- Battery: 12x2-10Ah
- Charger: DC-24V-2A



Control Unit



Code	Load Capacity (kg)	Lifting Range (mm)	Overall Size LxWxH (mm)	Unit Weight (kg)
V2190	100	130-1700	920x505x2160	65
V2191	150	130-1500	920x505x1950	65



# Trailer Stabilising Jack Stand

- The Trailer Stabilising Jack is a heavy-duty support system designed to provide unrivalled stability and safety for trailers with a capacity of up to 45 tonnes.
- Engineered for maximum strength and durability, this jack is perfect for use in a wide range of industrial and commercial applications, such as loading docks, warehouses, and transportation hubs
- Top Diameter: 200mm
- 200mm Rubber Wheel

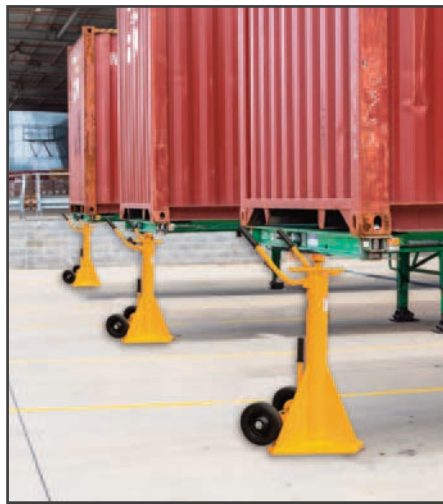

Code	Lifting Capacity (kg)	Static Capacity (kg)	Lifting Range (mm)	Overall Size LxWxH (mm)	Unit Weight (kg)
V2451	18,000	45,000	1000-1300	574x445x1300	40

# 10 Tonne Hydraulic Jack

- Great for jacking up containers & large equipment
- Removable pump hand lever
- The housing rotates 360 degrees

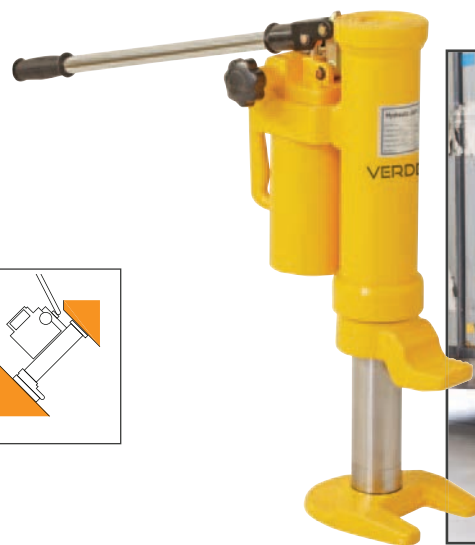
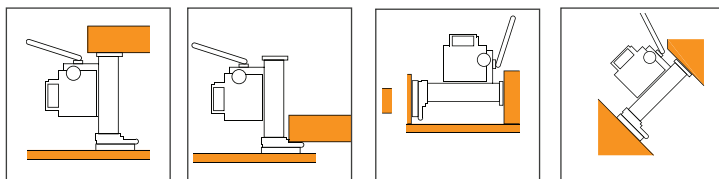

Code	Load Capacity (kg)	Lifting Range of Foot (mm)	Lifting Range of Head (mm)	Maximum Lever Force (kg)	Unit Weight (kg)
V2450	10,000	30-230	420-650	40	35





## Compact Ride-On Electric Materials Handling Tug

The Compact ride-on compact electric tug is the ultimate manual handling solution designed for goods transport for trolleys and anything that is difficult to push or pull around in the hospital, aged care and industrial warehouse environments.

The Materials Handling Electric Towing Tug is a ride-on unit that doesn't compromise its small size for a ride. Its compact size allows it to be effective in confined spaces, whilst being able to turn on its self. With a very low centre of gravity, the risk of tipping is greatly reduced. Its two front steer wheels create exceptional stability across many rough surfaces.

- Motor Voltage: 24 Volts
- Range: 30-60km



Watch a video of this in operation on our website here: [www.verdex.com.au/VI505](http://www.verdex.com.au/VI505)



Code	Push Capacity (kg)	Pull Capacity (kg)	Overall Size LxWxH (mm)	Wheel Base (mm)	Unit Weight (kg)
VI505	1200	1500	790x660x1340	620	115







# 1000kg Smart Tow Tug

Great for moving dollies, trolleys and roll cages throughout the warehouse, workshop or shopping centres etc. Compact design which makes it extremely manoeverable and easy to transport in vehicles.

- Travel Speed: up to 6km/h
- Programmable speed controller
- Battery: 24v, 18Ah & DC 24v, 300w
- Motor: DC 24v, 300w
- Rear Wheels Solid: 250mm
- Front Wheels Poly: 75mm
- Handle Height: 750-1050mm (adjustable)
- Turning Radius: 475mm



Attachments pictured are supplied as standard with the Tow Tug



Watch a video of this in operation on our website here: [www.verdex.com.au/V1500](http://www.verdex.com.au/V1500)



Code	Traction Capacity (kg)	Width (mm)	Overall Size LxH (mm)	Unit Weight (kg)
V1500	1000	465	810x490	65

**You May Also Like**



Furniture Mover Set - See page 62

## Manual Fork/Platform Stacker

- Foot pump hydraulic lift
- Comes with a removable platform and has 2 adjustable fork tines under platform for lifting skids and pallets
- Polyurethane castors - 2 x fixed, 2 x swivel with brakes
- Powder coated Finish



Adjustable fork tines for lifting skids and pallets



Watch a video of this in operation on our website here: [www.verdex.com.au/v2230](http://www.verdex.com.au/v2230)



Code	Load Capacity (kg)	Rear Castors (mm)	Front Castors (mm)	Platform Size (mm)	Fork Length (mm)	Lifting Range (mm)	Overall Size LxWxH (mm)	Unit Weight (kg)
V2230	400	125	75	660x580	650	75-1500	1040x590x1710	85

## Electric Fork/Platform Stacker

- Electric hydraulic lift
- Battery: 12v 80Ah
- Comes with a removable platform
- 2 adjustable fork tines under platform for lifting skids and pallets
- Polyurethane castors - 2 x fixed, 2 x swivel with brakes
- Load Capacity: 400kg
- Rear Castors: 125mm
- Front Castors: 75mm



Adjustable fork tines for lifting skids and pallets



Watch a video of this in operation on our website here: [www.verdex.com.au/v2231](http://www.verdex.com.au/v2231)



V2231S



V2231

Code	Details	Platform Size (mm)	Fork Length (mm)	Lifting Range (mm)	Overall Size LxWxH (mm)	Unit Weight (kg)
V2231	Electric Stacker	660x580	650	80-1500	1040x590x1710	120
V2231S	Stainelss Steel Electric Stacker	660x580	650	80-1500	1040x590x1710	120





## Aluminium Hand Stacker

- These aluminium lifters are great for assisting in the lifting, positioning and installation of goods up to 2500mm in height
- Manual hand winch control with automatic braking action
- Foot pedal brake
- Fits through standard doorways
- Quick set up - requires no tools
- Legs are straddle with quick adjustment
- Internal Adjustable Leg Dimensions: 570-940mm
- External Adjustable Leg Dimensions: 750-1120mm



Code	Load Capacity (kg)	Rear Castors (mm)	Front Castors (mm)	Platform Length (mm)	Load Centre (mm)	Lifting Range (mm)	Overall Size LxWxH (mm)	Unit Weight (kg)
V2250	180	200	50	570	254	50-2500	1100x736x1700	66

## Aluminium Lift Assist Device

- These aluminium lifters are great for assisting in the lifting, positioning and installation of goods at height.
- Ideal for lifting items into ceiling spaces or handling machine parts at height.
- Folds for easy storage and transport.
- Manual hand winch control with automatic braking action
- Fits through standard doorways.
- Quick set up - requires no tools.
- Legs fold up for easy storage.
- Arm Length: 800mm
- Load Capacity at a 400mm load centre: 350kg
- Load Capacity at a 1000mm load centre: 150kg



Watch a video of this in operation on our website here: [www.verdex.com.au/v2241](http://www.verdex.com.au/v2241)



Arm Length (mm)	Ground Clearance (mm)	Operating Length (mm)	Front Castors (mm)	Rear Castors (mm)
800	50	1880	100	125

Code	Min. Height (mm)	Max Height (mm)	Folded Size LxWxH (mm)	Unit Weight (kg)
V2241	150	5000	870x730x2000	145





## 120KG Fork/Platform Trolley

- Robust, light weight steel construction platform lift trolley which is ideal for lifting heavy items to a work bench level for working on
- The platform is removable and has 2 fork tines which are adjustable under platform for lifting small skids



Code	Load Capacity (kg)	Rear Castors (mm)	Front Castors (mm)	Platform Size (mm)	Fork Size (mm)	Lifting Range (mm)	Overall Size LxWxH (mm)	Unit Weight (kg)
V2255	120	200	50	500x420	50x420	95-1050	700x460x137	39

## Platform and Fork Lift Trolley

- The ideal trolley for lifting loads up to 150kg with ease
- Complies to relevant Australian Standards
- Swappable accessories for handling of different loads
- Forks for lifting small pallets and skids
- Platform for general lifting
- Patented silent winch which locks the load at any height
- Steel cable which runs inside the mast to prevent pinching
- Puncture proof rear wheels
- Made from aluminium
- Load Capacity (with forks): 150kg
- Load Capacity (with platform only): 120kg
- Platform Dimensions (DxW): 360x420mm
- Fork Dimensions (WxL) : 50x460mm



Watch a video of this in operation on our website here: [www.verdex.com.au/V2265](http://www.verdex.com.au/V2265)



Code	Details	Lift Height (mm)	Folded Size LxWxH (mm)	Overall Size LxWxH (mm)	Unit Weight (kg)
V2265	Platform Lift Trolley	1030	300x500x1320	710x530x1320	27
V2266	Fork Kit to suit V2265				



# Heavy Duty Manual Fork Stackers

- These manual fork stackers are a very heavy duty construction and are an economical alternative to forklifts
- Manual hydraulic lift via pallet truck style handle or foot pedal
- Straddle leg model for use with standard 1170mm Australian pallets
- Standard leg model for use on Euro pallets and small skids
- Lockable rear wheels are standard on all models
- Front Castors: 80mm
- Rear Castors: 150mm

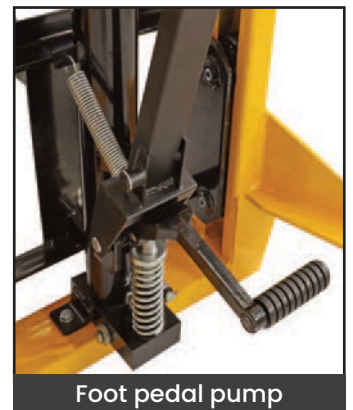
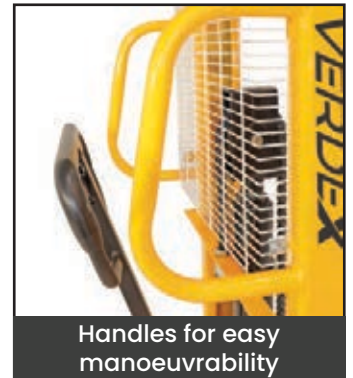

Watch a video of this in operation on our website here: [www.verdex.com.au/V2280](http://www.verdex.com.au/V2280)



Code	Details	Load Capacity (kg)	Lifting Range (mm)	Overall Width of Tines (mm)	Overall Size LxWxH (mm)	Unit Weight (kg)
V2280	Standard Leg Fork Stacker	500	90-1600	200-745	1640x805x2000	160
V2281	Straddle Leg Fork Stacker	500	70-1600	200-950	1600x1500x2000	225
V2282	Standard Leg Fork Stacker	1000	90-1600	200-700	1640x1000x2085	250
V2283	Straddle Leg Fork Stacker	1000	70-1600	200-950	1560x1450x2050	295



## Pallet Turntable Disc

- The Pallet Turntable Disc is designed specifically so that pallets can be placed on or removed from the turntable using only a hand pallet truck
- Lifting lug screws into the centre of the disc and makes transportation of the unit easy.
- Disc Diameter: 1105mm

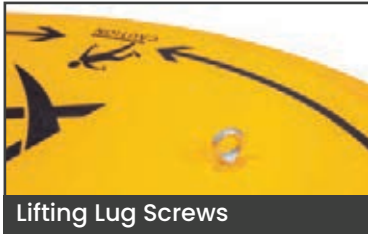

Lifting Lug Screws



Code	Load Capacity (kg)	Overall Size HxD (mm)	Unit Weight (kg)
V2145	2000	25x1235	120

## Pallet Rotator Ring

- The rotator ring is popular due to its light weight and easy maneuverability.
- It can be moved easily by one person.
- 16 roller bearings to ensure smooth rolling for heavy loads



Suits Pallet Lift Tables



Designed for loading and unloading pallets

Code	Load Capacity (kg)	Overall Size WxH (mm)	Unit Weight (kg)
V2140	1000	1000x65	36





# The Edge - Electric Pallet Truck

- The economical option for an electric pallet truck - avoid the strain of manually pushing a pallet standard pallet truck.
- Capacity up to 1500 kg and ability to overcome ramps up to 4/16% (loaded/unloaded) makes the truck suitable for work in loading docks and on delivery operations in different conditions
- The battery for this unit has a 3-6 hour battery life.
- Load Capacity: 1500kgs
- Min Fork Height: 85mm
- Lowered Height: 80mm
- Wheel Type: Polyurethane
- Travel Speed (unloaded): 5.8km/h
- Electric Brake
- Battery: 24V 20Ah
- Brushless AC motor
- Emergency stop button



Capacity up to **1500kg** and ability to overcome ramps up to **4/16%** (loaded/unloaded) makes the truck suitable for work in loading docks and on delivery operations in different conditions



Removable Lithium Battery



Pin can be set so only selected personnel can use the unit



Handle is supported by an air spring for smooth vertical return



Watch a video of this in operation on our website here: [www.verdex.com.au/v2388](http://www.verdex.com.au/v2388)



Code	Details	Load Capacity (kg)	Tine Size (mm)	Length of Tines (mm)	Overall Size LxW (mm)	Unit Weight (kg)
V2388	The Edge (540mm Wide)	1500	47x160x1150	1185	1530x540	123
V2385	The Edge (685mm Wide)	1500	47x160x1150	1185	1530x685	126
V2386	The Edge - Additional Battery 24V/20Ah					
V2387	Extra Battery Charger					4.6



## 2500KG Industrial Pallet Trucks

- All our pallet trucks come with a maintenance free pump. This means they are all made using high quality parts and German seal kits and are fitted with long life rollers and steering wheels.
- These safety yellow powder coated trucks are available in standard size 685mm wide, narrow pallet size 520mm and small skid size 450mm wide
- Steering Wheel Size: 50x180mm
- Rear steering wheels and fixed front castors



Code	Details	Load Capacity (kg)	Tine Size (mm)	Fork Length (mm)	Width (mm)	Overall Length (mm)	Lifting Range (mm)	Unit Weight (kg)
V2322	Standard Size - Poly Wheels	2500	50x160	1150	685	1550	85-190	70
V2323	Standard Size - Nylon Wheels	2500	50x160	1150	685	1550	85-190	67
V2326	Euro Size Pallet Truck - Poly Wheels	2500	50x160	1150	520	1550	85-190	60
V2325	Small Skid Size - Poly Wheels	2500	50x160	1150	450	1550	85-190	66

## Low Profile Pallet Truck

- Easy access into low skids and pallets.
- Great for unloading containers with low import type pallets with a low clearance of only 51mm.
- Powder coated safety yellow
- Steering Wheel Size: 50x180mm
- Comes standard with nylon wheels, however polyurethane available on request
- Tine Size (HxW): 470x160mm
- Min Fork Height: 51mm



Watch a video of this in operation on our website here: [www.verdex.com.au/v2330](http://www.verdex.com.au/v2330)



Code	Details	Load Capacity (kg)	Fork Length (mm)	Width (mm)	Overall Length (mm)	Unit Weight (kg)
V2330	Low Profile Pallet Truck - Nylon Wheels	1500	1120	685	1550	80
V2329	Low Profile Pallet Truck - Polyurethane Wheels	1500	1120	685	1550	80



# Super-Low Profile Pallet Truck

- Easy access into low skids and pallets.
- Great for unloading containers with low import type pallets with a super low clearance of only 35mm.
- Powder coated safety yellow
- Steering Wheel Size: 50x160mm
- Polyurethane rear wheels and steel rollers as front wheels to achieve an extremely low clearance



Watch a video of this in operation on our website here: [www.verdex.com.au/V2331](http://www.verdex.com.au/V2331)



Code	Load Capacity (kg)	Tine Size (mm)	Length (mm)	Width (mm)	Lifting Range (mm)	Unit Weight (kg)
V2331	1000	30x160	1120	520	35-91	100

# Extra Long 2000KG Pallet Trucks

- These extra long pallet trucks are extremely useful for extra deep pallets
- Available in 1800 and 2500mm
- Also can be used to pickup two pallets in one lift.
- Tine Size: 60x160mm
- Steering Wheel Size: 50x200mm
- Powdercoated safety yellow
- Polyurethane wheels as standard however nylon wheels can be ordered if required



Watch a video of this in operation on our website here: [www.verdex.com.au/V2345](http://www.verdex.com.au/V2345)



Code	Details	Load Capacity (kg)	Tine Size (mm)	Length (mm)	Width (mm)	Min. Fork Height (mm)	Unit Weight (kg)
V2345	Extra Long Pallet Truck	2000	60x160	1800	520	85	100
V2346	Extra Long Pallet Truck	2000	60x160	1800	685	85	110
V2347	Extra Long Pallet Truck	2000	60x160	2500	685	85	285





## 2000kg Galvanised Pallet Trucks

- These galvanised pallet trucks are available in both standard size 680mm wide and Euro pallet size 520mm
- Ideal for the food, chemical and pharmaceutical industry or outdoor use
- Steering Wheel Size: 50x200mm
- Nylon wheels
- Tine Size: 60x160mm



Watch a video of this in operation on our website here: [www.verdex.com.au/V2335](http://www.verdex.com.au/V2335)



Code	Details	Load Capacity (kg)	Length (mm)	Width (mm)	Min. Fork Height (mm)	Unit Weight (kg)
V2335	Galvanised Pallet Truck (Standard Size)	2000	1120	685	85	67
V2336	Galvanised Pallet Truck (Euro Size)	2000	1150	520	85	65

## Stainless Steel Pallet Trucks

- Ideal for the food, chemical and pharmaceutical industry or where corrosive acids are used.
- The front wheels are fully enclosed which is required for clean rooms and food environments.
- Grade of Stainless: 316
- Tine Size: 60x160mm
- Steering Wheel Size: 50x200mm
- Nylon wheels



Watch a video of this in operation on our website here: [www.verdex.com.au/V2340](http://www.verdex.com.au/V2340)



Code	Details	Load Capacity (kg)	Length (mm)	Width (mm)	Min. Fork Height (mm)	Unit Weight (kg)
V2340	Stainless Steel Pallet Truck (Standard Size)	2000	1150	685	85	75
V2341	Stainless Steel Pallet Truck (Euro Size)	2000	1150	520	85	72





## 2000KG Pallet Trucks With Load Scales

- Our scale pallet trucks are extremely reliable and highly accurate in measuring your pallet weight.
- This fork truck has a totalising function which adds up multiple pallet weights giving the total weight per shipment or order.
- The weighing unit uses four AA batteries which give approx 4200 weighting actions
- The unit gives a low battery warning and shuts off after 3 minutes
- Optional scale printer unit available on request
- Scale Increments: 1kg
- Scale Functions: Zero correction, gross/net weight, total weight
- Nylon Wheels
- Steering Wheel Size: 50x180mm
- Tine Size: 50x182mm



Watch a video of this in operation on our website here:  
[www.verdex.com.au/V2350](http://www.verdex.com.au/V2350)



Code	Details	Load Capacity (kg)	Fork Length (mm)	Width (mm)	Min. Fork Height (mm)	Overall Size LxW (mm)	Unit Weight (kg)
V2350	Pallet Truck With Load Scales	2000	1150	690	76	1650x690	113
V2350N	Narrow Pallet Truck With Load Scales	2000	1150	690	76	1650x555	113

## Stainless Steel 2000kg Pallet Truck With Load Scales

- These stainless steel pallet trucks are ideal for applications in the food and medical industries or areas where corrosive acids are used.
- Fully stainless steel - 316 grade
- Scale Increments: 2kg
- Scale Functions: Zero correction, gross/net weight, total weight
- Steering Wheel Size: 50x180mm
- Nylon Wheels

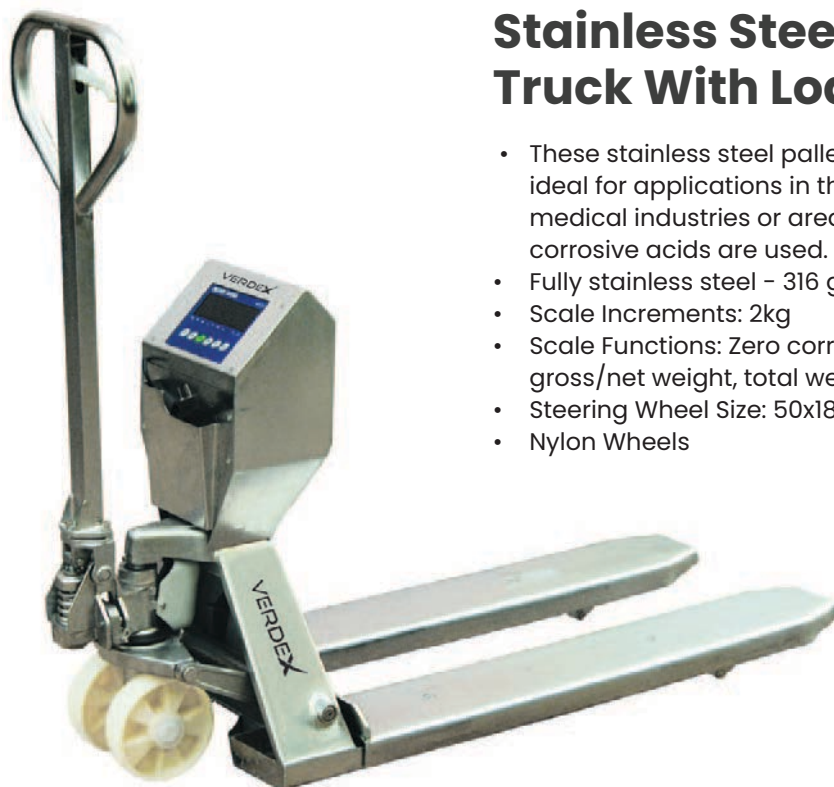

Code	Load Capacity (kg)	Tine Size (mm)	Length (mm)	Width (mm)	Min. Fork Height (mm)	Unit Weight (kg)
V2355	2000	50x182	1150	690	85	138



## 5 Tonne Heavy Duty Pallet Truck

- These extra heavy duty pallet trucks can be used to move heavy machinery and come with a towing hook for pulling if required
- Steering Wheel Size: 50x200mm
- Tine Size: 50x160mm
- Powder coated safety yellow
- Steel roller wheel



Heavy duty steel rollers



Watch a video of this in operation on our website here: [www.verdex.com.au/V2365](http://www.verdex.com.au/V2365)



Code	Load Capacity (kg)	Length (mm)	Width (mm)	Lifting Range (mm)	Unit Weight (kg)
V2365	5000	1150	680	90-200	130

## Rough Terrain Pallet Truck

This rough terrain pallet truck is great for applications such as timber yards, brick yards and hard stand areas where the ground is gravel or rough.

- Large pneumatic wheels
- Adjustable Fork Width: 228-735mm
- Width Inside Front Wheels: 1230mm
- Front Wheel Size: 550x132mm (Dia x Width)
- Rear Wheel Size: 265x80mm (Dia x Width)
- Turning Radius: 1500mm
- Axle Distance between Front and Rear Wheels: 973mm



Code	Load Capacity (kg)	Load Centre (mm)	Tine Size (mm)	Fork Length (mm)	Lifting Range (mm)	Overall Size LxWxH (mm)	Unit Weight (kg)
V2360	1200	450	100x50	860	63-233	1375x1605x1200	245





## Manual Hi-Lift Pallet Trucks

- Great for lifting skids and pallets with no bottom rail
- Extremely easy to pump and light weight
- Quick-lift as standard with automatic transfer to normal lifting loads over 150kg
- Automatic descending speed control, regardless of load
- Front support legs and adjustable stabilisers ensure maximum stability
- Heavy duty design
- Conforms to EN 1757-4
- Not suitable for closed pallets with a bottom rail

*Stainless Steel option is available as a special order*



Code	Load Capacity (kg)	Length (mm)	Width (mm)	Lifting Range (mm)	Tine Size (mm)	Lifting Range (mm)	Unit Weight (kg)
V2371	1000	1100	520	85-800	50x160	85-800	118
V2370	1000	1150	680	85-800	50x160	85-800	125

## Electric Hi-Lift Pallet Trucks

- Great for lifting skids and pallets with no bottom rail
- Quick-lift as standard with automatic transfer to normal lifting loads over 150kg
- Automatic descending speed control, regardless of load
- Front support legs and adjustable stabilisers ensure maximum stability
- Heavy duty design
- Conforms to EN 1757-4
- Not suitable for closed pallets with a bottom rail
- Battery: 12v, 54Ah

*Stainless Steel option is available as a special order*



Code	Load Capacity (kg)	Length (mm)	Width (mm)	Lifting Range (mm)	Tine Size (mm)	Lifting Range (mm)	Unit Weight (kg)
V2373	1500	1100	520	85-800	50x160	85-800	150
V2372	1500	1150	680	85-800	50x160	85-800	160



## Fork Extension Slippers / Tines (Galvanised)

- Fork slippers extend the versatility of your lift truck
- The safe working load (SWL) is measured per pair at 600mm load centre
- Slippers conform to relevant Australian Standards
- Designed and manufactured in accordance with AS2359.15 and other relevant Australian standard which requires the slippers used for general usage to be not longer than 167% of the supporting tine's length.



Code	*SWL (kg)	Length (mm)	Internal Tine Size (mm)	External Tine Size (mm)	HCG (mm)	Weight Per Pair (kg)
V2405	*4500	1780	138x55	150x67	845	66
V2406	*4500	2400	138x55	150x67	1154	88
V2407	*8500	1800	170x76	185x92	830	133
V2408	*8500	2400	170x76	185x92	1154	177
V2409	*8500	3000	170x76	185x92	1454	221

\*SWL shown here is the maximum however it varies depending on forklift capacity - Refer to load capacity plate on your forklift

## Slip-On Roll Forklift Prong

Slip-on Roll Prong suitable for fabric, cable, carpet and coil products. These attachments quickly adapt to almost any forklift and require only the connection of a safety chain to prevent unintentional disengagement.

- Prongs are manufactured from solid steel
- Finish: Zinc Plated
- The safe working load (SWL) is measured at 1400mm load centre
- SWL: 510kg
- Prong Overall Length: 3940mm



Code	Prong Diameter (mm)	Length (mm)	Fork Pocket Size (mm)	Fork Centres (mm)	HCG (mm)	Unit Weight (kg)
V2415	70	2800	190x65	345	1553	163



## Forklift Drum Cable Slippers

- These attachments are designed to fit onto the forks of a forklift, allowing the forklift to safely lift and move cable drums without damaging the drums or the forklift.
- Designed to suit spindle up to 50 - 80mm diameter
- Supplied with 1200 long x 48mm diameter spindle
- Powder coated finish
- Designed and fabricated strictly in accordance with relevant Australian Standards
- AS/NZS 1554.1: 2011 Structural Steel Welding (*see online for more details*)



Code	Capacity (kg)	Length (mm)	Max. Tine Size (mm)	VCG (mm)	HCG (mm)	Unit Weight (kg)
V2417	1000	1300	100x45	48	734	34
V2418	1500	1300	130x50	50	684	50
V2419	2000	1300	155x55	50	664	62

## Cable Drum Stirrups

- The V2416 Cable Drum Stirrups is an affordable solution to lift and transport cable drums by forklift.
- Cradle to suit up to 50mm diameter spindles
- Supplied with a 48mm diameter x 1200mm long spindle
- Locking bolt safely secures the drum stirrup in position on forks
- Supplied as a pair
- Enamel paint finish



Please note; Cable Drum isn't supplied with Stirrups



Code	Working Load Limit (kg)	Max. Fork Arm Width (mm)	Fork Pocket Size (mm)	Unit Weight (kg)
V2416	2000	130	150x45	30/pair



## Fork Spreader with Load Guard

The V2476 fork spreader evenly distributes the load over the length of the attachment with a load back guard to help secure high loads. The slip-on attachment is secured to the lift truck by a safety chain.

- Capacity: 3000kg at 600mm Load Centre
- Load Guard Height: 560mm



Code	Spreader Width (mm)	Spreader Depth (mm)	Fork Pocket Size (mm)	Fork Pocket Centres (mm)	Tine Size LxWxH (mm)	Unit Weight (kg)
V2476	3000	1200	160x60	872	1050x100x45	255

## 2.5 Tonne Forklift Tine Hook

- Converts forklift into a mobile crane in seconds
- Adjustable mounting position along the length of the fork
- Secured to forks by thumb screw
- Swivel hook includes safety latch
- Powder coated yellow



Image shown with (Lift Table V2110)

Code	Load Capacity (kg)	Fork Pocket Size LxW (mm)	Unit Weight (kg)
V2440	2500	150x60	25



## Bulk Bag Jib (3 Tonne)

- This Bulk Bag Jib is designed to safely handle and move bulk bags by both forklift and overhead crane.
- Versatile design allows easy transfer from forklift to crane and vice versa.
- Fitted with four safety swivel hooks for securing the bulk bag straps at 800mm centres
- Allows for one handed connection and disconnection of straps
- Certified to relevant Australian Standards
- Zinc finish



Code	Safe Working Load (kg)	Load Centre (mm)	Jib Size LxW (mm)	Fork Pocket Size (mm)	Fork Pocket Centres (mm)	Hook Centres (mm)	Unit Weight (kg)
V2438	3000	450	900x860	185x85	500	800	85

## Bulk Bag Lifter

- Designed for lifting bulk bags by overhead crane
- Enamel paint finish
- Designed with 4 lifting loops for easy positioning of bulk bag
- Suits 80cm standard bulk bags



Code	Safe Working Load (kg)	Hook Centre 'A' (mm)	Hook Centre 'B' (mm)	Unit Weight (kg)
V2537	2000	800	1170	45

## Crane / Forklift Spreader Beam

- Using a Crane, loads can be lifted via the centre single hook point (as a 'Lifting Beam'), or end lifted using a 2 leg Chain Sling (as a 'Spreader Beam').
- If lifting by forklift, the 600mm long slipper pockets allow for fast and safe connection to the truck.
- The Spreader Beam load connection points are adjustable to 3 positions by moving the extendable arms each end.
- Both extendable arms are locked into position via safety pins.
- The unit is supplied standard with a safety swivel hook each end.
- Zinc plated arms with the main body painted in 'safety orange'.



Rated Capacity When used as	Fully Retracted (LC @ 2405mm)	Middle Position (LC @ 3165mm)	Fully Extended (LC @ 3925 mm)
Forklift Attachment	3500kg	1500kg	750kg
Lifting Beam	4500kg	2500kg	1300kg
Spreader Beam	9000kg	7200kg	5600kg

Code	F/Lift HCG (mm)	Rated Capacity (kg)	Fork Pocket Size (mm)	Fork Centres (mm)	Overall Size (mm)	Unit Weight (kg)
V2470	2405	9000	190x65	900	2600x600x410	172

## Heavy Duty Pallet Hook (4500kg)

A heavy duty 4.5 tonne capacity pallet hook for loads up to 4500kg. Fully adjustable tines makes this unit extremely versatile. Load balancing is carried out by positioning the lifting ring to suit the Centre of Gravity of the load.

Load balancing is via the moveable lifting ring. The Pallet Hook has been designed & certified in accordance with relevant Australian Standards

- Clearance is the distance between tines and head
- Finish: Enamel painted



Code	SWL (kg)	Load Centre (mm)	Tine Size (mm)	Clearance Between Tines and Head (mm)	Unit Weight (kg)
V2460	4500	600	125x50x1070	1405	456





## Automatic Pallet Hook (2000kg)

The automatic pallet hook, type V2462, is self-levelling for ease of operation. An internal spring mechanism ensures the lifting eye is in the correct position to keep the tines horizontal, eliminating the need to reposition the lifting ring. Enclosed frame members protect the operator from moving parts. The Pallet Hook has been designed & certified in accordance with relevant Australian Standards

- Clearance is the minimum distance between tines and head
- Finish: Zinc plated



Code	SWL (kg)	Load Centre (mm)	Adjustable Tine Size (mm)	Clearance (mm)	Unit Weight (kg)
V2462	250-2000	600	100x45x1055	1355	196

## Adjustable Pallet Hook (2200kg)

The V2461 Pallet Hook features variable body height and adjustable tine width, making this versatile attachment ideal for the transport and construction industry.

Load balancing is via the moveable lifting ring. The Pallet Hook has been designed & certified in accordance with relevant Australian Standards

- Adjustable Clearance is the distance between tines and head
- Finish: Zinc plated

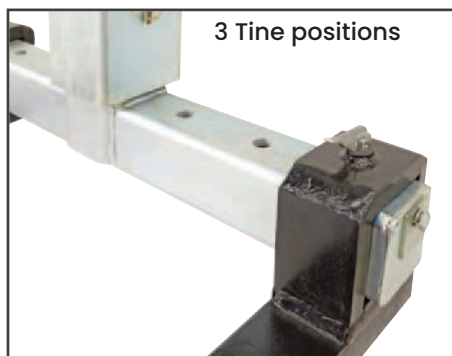

Code	SWL (kg)	Load Centre (mm)	Tine Size (mm)	Adjustable Clearance (mm)	Unit Weight (kg)
V2461	2200	600	100x45x1055	1005-1605	215

## 4.5 Tonne Telescopic Short Jib

- This 4500kg telescopic short fixed jib is designed as an affordable general purpose jib which is great for confined spaces and has a 1.9 metre reach when fully extended.
- Finish: Zinc plated
- 4 jib positions
- Load Centre: 670mm

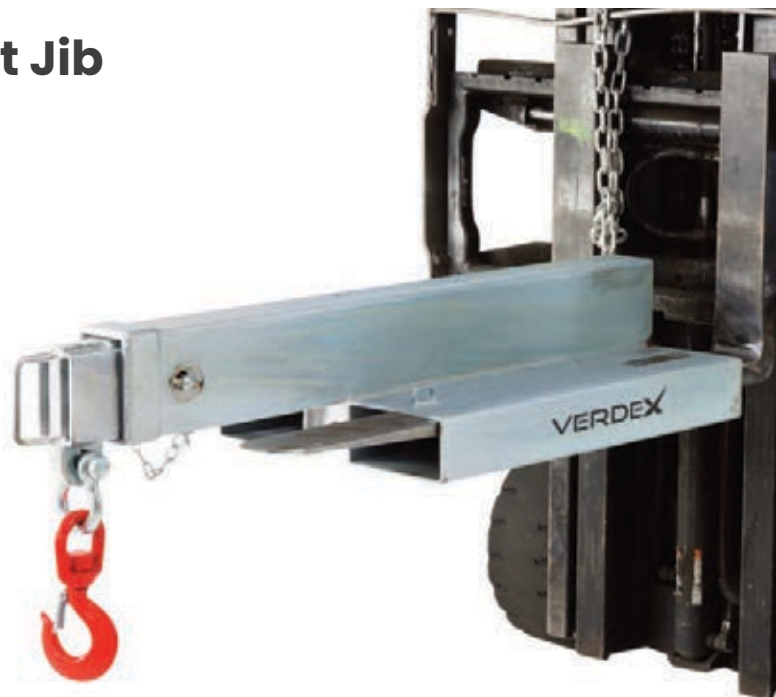

SAFE WORKING LOADS (SWL) PER POSITION				
POSITION	1	2	3	4
EXTENSION (mm)	670	1165	1545	1925
SWL (kg)	4500	2900	1300	750

Code	SWL (kg)	HCG (mm)	Jib Length When Closed (mm)	Jib Length When Extended (mm)	Fork Pocket Size (mm)	Fork Pocket Centres (mm)	Unit Weight (kg)
V2420	4500	542	1250	1900	185x65	290	95

## 4.5 Tonne Telescopic Long Jib

- This 4500kg tonne telescopic jib is a general purpose jib which is great for reaching across pits and areas where the forklift cant drive up to as it has a 3.5 metre reach when fully extended.
- Safe Working Load: 4500kg
- Load Centre: 870mm
- HGC: 836mm
- Finish: Zinc plated
- 6 jib positions
- Overall Dimensions at position 1 (LxWxH): 2040x490x250mm



SAFE WORKING LOADS (SWL) PER POSITION						
POSITION	1	2	3	4	5	6
EXTENSION (mm)	870	1945	2325	2705	3085	3465
SWL (kg)	4500	1300	750	560	380	200

Code	SWL (kg)	Jib Length When Closed (mm)	Jib Length When Extended (mm)	Fork Pocket Size (mm)	Fork Pocket Centres (mm)	Unit Weight (kg)
V2421	4500	2000	3500	185x65	290	140



## 2.0 Tonne Hook & Tow Jib Attachment

This 2000kg hook & tow jib is suitable for most forklifts and is a simple slip-on attachment with safety chain and swivel hook as pictured.

- Safe Working Load: 2000kg at 1160mm load centre
- Finish: Zinc plated
- Maximum weight on towball can't exceed 500kg
- Hook jib has 2 lifting positions
- Overall Dimensions at position 1:  
(LxWxH): 1410x420x140mm

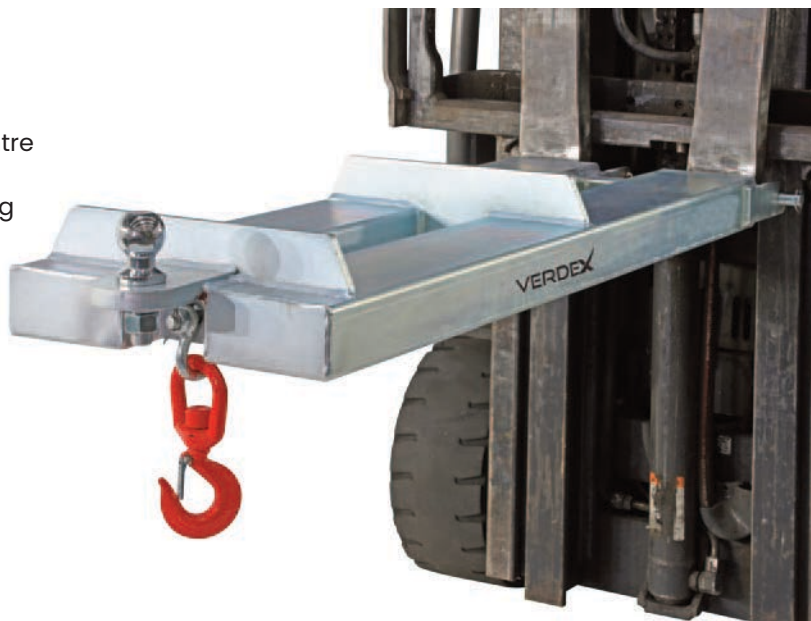
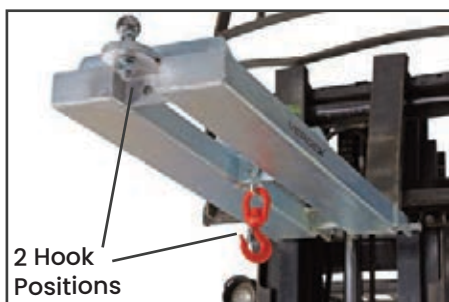

Code	Details	SWL (kg)	Fork Pocket Size (mm)	Fork Pocket Centres (mm)	Fork Pocket Length (mm)	Unit Weight (kg)
V2429	Hook Jib - 2.0 Tonne Capacity	2000	140x65	250	1220	45
V2430	Hook & Tow Jib - 2.0 Tonne Capacity	2000	140x65	250	1220	45

## 4.5 Tonne Long Tilting Jib

This 4500kg long tilting jib is the most versatile jib in our range and allows for additional height of up to 2.23 metres.

- SWL chart is show in table
- Finish: Zinc plated
- 6 jib positions
- Overall Dimensions when closed  
(LxWxH): 2100x520x650mm
- HGC: 735mm
- Load Centre: 770mm



### SAFE WORKING LOADS (SWL) PER POSITION

POSITION	1	2	3	4	5	6
EXTENSION (mm)	770	2010	2390	2770	3150	3530
SWL (kg)	4500	1100	630	470	300	150

Code	SWL (kg)	Jib Length When Closed (mm)	Jib Length When Extended (mm)	Fork Pocket Size (mm)	Fork Pocket Centres (mm)	Unit Weight (kg)
V2422	4500	2100	3530	185x65	322	190





## Deluxe Drum Cradle

- Heavy duty drum cradle with retractable handles for use on 210 litre steel drums
- Great for moving drums around the site and to lay drums into the side position.
- Durable zinc plated finish
- Single person operation
- Wheel Type: Nylon



Code	Load Capacity (kg)	Length (mm)	Width (mm)	Horizontal Height (mm)	Unit Weight (kg)
V5000	300	1000	370	450	14.5

## Steel Drum Palletiser

- Loads and unloads drums to and from the corner of a pallet
- Suit steel drums with rim tops
- Locking handle holds weight of drum for easy transport
- Wheel Type: Polyurethane



Code	Load Capacity (kg)	Overall Size LxWxH (mm)	Unit Weight (kg)
V5020	365	800x1220x1160	85

## Low Profile Drum Trolley

- This drum trolley has a built in handle which is used for tilting the drum back to push the trolley under.
- Handle has built in bung remover and seal remover
- Wheel Size: 150x50mm (front), 75x32mm (rear)
- Raises drum 25mm



Code	Load Capacity (kg)	Overall Size HxDxW (mm)	Unit Weight (kg)
V5045	500	950x570x750	17



## Steel Drum Carrier / Rotator

- Remarkably versatile 210 litre Drum Carrier/Rotator Raises, transports, rotates, tilts and drains fully loaded drums
- Lockable in horizontal or vertical position
- Can be turned end over end to agitate contents
- 2 x 200mm roller bearing castors and 1 x 100mm swivel castor



Code	Load Capacity (kg)	Length (mm)	Height (mm)	Width (mm)	Clearance under drum while horizontal (mm)	Unit Weight (kg)
V5005	370	1250	1180	900	370	42

## Plastic Drum Carrier / Rotator

- Remarkably versatile 210 litre Drum Carrier/Rotator Raises, transports, rotates, tilts and drains fully loaded plastic drums
- Lockable in horizontal or vertical position
- Can be turned end over end to agitate contents
- 200mm roller bearing castors and 100mm swivel castor
- Powder coated steel



Code	Load Capacity (kg)	Length (mm)	Height (mm)	Width (mm)	Clearance under drum while horizontal (mm)	Unit Weight (kg)
V5006	370	1250	1180	900	370	47

## Steel & Plastic Drum Trolley

- This drum trolley suits both steel and plastic 210 litre drums
- Suits plastic drums with a top lip
- Hydraulic handle pump which provides smooth easy lifting



Watch a video of this in operation on our website here: [www.verdex.com.au/v5015](http://www.verdex.com.au/v5015)



Code	Load Capacity (kg)	Overall Size LxWxH (mm)	Minimum beak height (mm)	Maximum beak height (mm)	Unit Weight (kg)
V5015	250	820x800x1050	855	1160	42

## Steel & Plastic Drum Trolley

- These drum trolleys are ideal for transporting both steel and plastic drums and are available in solid wheel and pneumatic wheels for rough and uneven ground
- This trolley is also self-standing which means the operator can leave without drums falling over
- Wheels: 400mm front, 75mm castors on the rear



V5026



V5025

Code	Details	Load Capacity (kg)	Overall Size LxWxH (mm)	Unit Weight (kg)
V5025	Steel/Plastic Drum Trolley (Solid Wheel)	450	750x700x1050	24
V5026	Steel/Plastic Drum Trolley (Pneumatic Wheel)	450	750x700x1050	28





## Steel & Plastic Drum Lifter/Palletiser

- This drum trolley suits both steel and plastic 210 litre drums.
- Spring loaded clamp grabs the drum rib with no manual input
- The lifter has a brake to avoid rolling on sloped areas



Code	Load Capacity (kg)	Lifting Height (mm)	Length (mm)	Height (mm)	Width (mm)	Unit Weight (kg)
V5030	400	1070	1100	1830	910	100

## Drum Palletiser Stackers

- These drum palletisers stackers are great for loading and unloading both plastic and steel drums onto pallets
- Can also be used to stack drums on top of another drum or to place on a truck or ute
- V5036 comes with a battery operated weighing scale which gives you an accurate measurement of the drums weight
- Powder coated Steel



Code	Details	Load Capacity (kg)	Max Lift Height (mm)	Leg Length (mm)	Overall Size LxWxH (mm)	Unit Weight (kg)
V5035	Drum Palletiser Stacker	450	1100	500	1140x950x1870	130
V5036	Drum Palletiser Stacker (with load scales)	450	1100	500	1150x950x1870	135

## Hydraulic Drum Truck

- Easily transport steel drums with this drum truck
- Designed to streamline drum handling tasks, this drum truck offers unmatched convenience and versatility in industrial environments
- Pallet truck style design
- Powder coated steel
- Nylon wheels



Code	Load Capacity (kg)	Min Arm Height (mm)	Max Arm Height (mm)	Radius of Arm (mm)	Overall Size LxW (mm)	Unit Weight (kg)
V5040	365	270	390	270	1022x722	53

## Drum Dollies

- Drum dollies are suitable for both steel and plastic drums and containers
- Powder coated and stainless steel options
- Heavy duty easy wheel castors
- 3 versions available
- Castor Size: 75mm



V5051



V5051 pictured with Drum



V5050



V5052

Code	Details	Load Capacity (kg)	Overall Size LxWxH (mm)	Inner Diameter (mm)	Outer Diameter (mm)	Unit Weight (kg)
V5050	Drum Dollie (Powder coated)	300	710x710x150	600	710	7.5
V5051	Drum Dollie (Stainless Steel)	300	710x710x150	600	710	7.5
V5052	Heavy Duty Drum Dollie (Powder coated)	500	630x630x150	615	630	9



## Drum Tongs

- For lifting steel drums with an overhead crane or the fork tine hook
- To operate, set locking lever in locked open position
- Hooks automatically engage when lifted and disengage when the drum is put down
- Suitable for steel drums

Code	Load Capacity (kg)	Jaw Opening Distance (mm)	Unit Weight (kg)
V5055	500	910	8



## 100 & 110L Enviro Drum Hooks

- These Drum Hooks are designed for lifting 100 & 110L enviro drums.
- Crafted with precision and durability in mind, these hooks are essential tools for handling drums in various industrial & commercial settings.
- Hot dipped galvanised finish
- Working load Limit: 200kg

Code	Details	Overall Size LxWxH (mm)	Unit Weight (kg)
V5053	100L Enviro Drum Hook	390x40x215	1.6
V5054	110L Enviro Drum Hook	490x40x170	2



## Hook Drum Lifter

- Suitable for both steel and plastic 210 litre drums
- Works on any drum that has a rim to grab onto
- Ideal for picking up a drum in the middle of a cluster without having to move any that are in front



Code	Load Capacity (kg)	Overall Size HxWxD (mm)	Unit Weight (kg)
V5056	500	215x711x711	13

## Drum Sling Lifter

- This sling lifter is ideal for lifting drums and cylinders using an overhead crane or forklift lifting hook device
- Suits up to 210 litre drums
- Supplied with metal head ring

Code	Details	Sling Length (mm)	Unit Weight (kg)
V5057	Drum Sling Lifter - 500kg	1100	3
V5058	Drum Sling Lifter - 1000kg	1100	4





## Forklift Geared Drum Rotator

- Converts your forklift into a drum handler
- Suitable for 210 litre steel and plastic drums
- Easily attached to most fork trucks
- Able to lift, raise and tilt loaded drums
- Finish: Painted safety yellow
- Drum Size: 570-600mm



Code	Load Capacity (kg)	Fork Pocket Size (mm)	Fork Pocket Centres (mm)	Unit Weight (kg)
V5065	300	150x55	825	60

## Forklift Drum Rotator

- Converts your forklift into a drum handler
- Suitable for 210 litre steel drums
- Easily attached to most fork trucks
- Able to lift, raise and tilt loaded drums
- 3 metre pull chain from operators seat
- 30:1 gearing ratio
- Finish: Painted safety yellow



Code	Load Capacity (kg)	Fork Pocket Size (mm)	Drum Size dia. (mm)	Unit Weight (kg)
V5066	380	180x65	570-600	97



## Drum Tipper / Dumper

- Fast and efficient solution to emptying 205 litre steel drums, ideally suited to waste and scrap products
- The drum is secured with the sturdy belly strap & locked in place with the over-centre catch & locking pin
- A rope draw chord is pulled from the driver's seat to dump the drum where required. A custom locking mechanism is fitted to prevent accidental release while driving over bumpy ground
- Rotational ability 180 degrees



Code	Working Load Limit (kg)	Load Centre (mm)	Fork Pocket Size (mm)	Fork Pocket Centres (mm)	Overall Size LxWxH (mm)	Unit Weight (kg)
V5069	500	1000	185x65	840	1400x1040x600	85

## Galvanised Forklift Drum Grab

- Attaches quickly and easily to most fork trucks
- Heavy duty welded steel construction
- Lifts, transports and deposits steel drums without having to leave the drivers seat
- Finish: Galvanised
- Load Centre: 1340mm
- HCG: 824mm



Watch a video of this in operation on our website here: [www.verdex.com.au/v5076](http://www.verdex.com.au/v5076)



Code	Load Capacity (kg)	Fork Pocket Size (mm)	Fork Pocket Centres (mm)	Unit Weight (kg)
V5076	500	165x65	325	78



## Forklift Drum Grab

- Attaches quickly and easily to most fork trucks
- Heavy duty welded steel construction
- Lifts, transports and deposits steel drums without having to leave the drivers seat
- Finish: Painted safety yellow

Code	Load Capacity (kg)	Fork Pocket Size (mm)	Fork Pocket Centres (mm)	Unit Weight (kg)
V5075	680	177x58	330	56





## Parrot Beak Drum Lifters

- Suitable for both steel and plastic 210 litre drums
- Simple auto clamp operation, no need to leave the drivers seat
- Allows the operator to remove and place drums on pallets or bunds without having to leave the forklift seat
- Height adjustable for use with different drum shapes
- Available in single and double drum pickups
- Finish: Painted safety yellow



V5080



V5081



Watch a video of this in operation on our website here: [www.verdex.com.au/v5080](http://www.verdex.com.au/v5080)



Code	Details	Load Capacity per beak (kg)	Fork Pocket Size LxWxH (mm)	Fork Pocket Centres (mm)	Unit Weight (kg)
V5080	Parrot Beak Drum Lifter (single)	360	750x150x55	500	45
V5081	Parrot Beak Drum Lifter (double)	360	750x150x55	590	62

## Galvanised Parrot Beak Drum Lifter

- Suitable for both steel and plastic 210 litre drums with a top lip
- Simple auto clamp operation - no need to leave the drivers seat
- Allows the operator to remove and place drums on pallets or bunds without having to leave the forklift seat
- Finish: Zinc plated
- HCG: 560mm
- VCG: 130mm



Code	Load Capacity (kg)	Load Centre (mm)	Fork Pocket Size (mm)	Fork Pocket Centres (mm)	Unit Weight (kg)
V5085	1000	1210	185x60	250	72





## Drum Positioner

- Suitable for both steel and plastic 210 litre drums
- Can change drum position from vertical to horizontal & vice-versa
- Hinged tines automatically lock when lowered to the ground in horizontal position
- Suitable for loading drums onto transport vehicles
- Works great for loading & unloading drums off rack stands
- Can be operated without the driver having to leave the forklift seat



Watch a video of this in operation on our website here:  
[www.verdex.com.au/v5090](http://www.verdex.com.au/v5090)



Code	Load Capacity (kg)	Prong Distance Apart (mm)	Fork Pocket Size (mm)	Fork Pocket Centres (mm)	Overall Size LxWxH (mm)	Unit Weight (kg)
V5090	400	575	150x60	420	1800x700x660	75

## Fixed Prong Drum Positioner

- Suitable for both steel and plastic 210 litre drums
- Works great for loading and unloading drums off rack stands



Code	Load Capacity (kg)	Prong Distance Apart (mm)	Fork Pocket Size (mm)	Fork Pocket Centres (mm)	Overall Size LxWxH (mm)	Unit Weight (kg)
V5091	300	565	140x50	560	1360x715x120	42

## Forklift Side Operated Drum Rotator (Chain Drive)

- Empties a standard 205 litre drums with minimal effort
- Suitable for drum rotation up to 3m above ground
- Rotation carried out via hand chain
- Belly strap and eccentric lock secures drum in position
- Locking pin prevents accidental release
- Slip-on attachment allows quick connection to a forklift
- Can be coupled with the Plastic Barrel Option
- Zinc finish
- Rotation: 360°



Code	Load Capacity (kg)	Load Centre (mm)	Fork Pocket Size (mm)	Fork Pocket Centres (mm)	Unit Weight (kg)
V5068	400	940	185x60	840	90



## Side Shift Drum Palletiser

- The Side Shift Drum Palletiser is specially designed for moving drums and barrels from any position on a pallet.
- It uses a sliding side-shift arrangement allowing it to even be used for moving containers and drums placed in the centre of a pallet.
- The palletiser straddles the pallet and only requires access to one side, thus allowing pallets in confined areas to be kept against the wall even when unloading.
- When moving the drum onto another pallet, scales or the floor, the drum can also be moved to either side using the side-shift arrangement
- This unique design side shift drum palletiser can pickup drums from any position on the pallet, skid or bund -straddles beside and over the pallet
- Suitable for both steel and plastic drums
- The operator requires only 12kg of force on the handle to lift a 300kg drum



Watch a video of this in operation on our website here: [www.verdex.com.au/V5160](http://www.verdex.com.au/V5160)



Spring loaded clamp securely holding the drum



Handle lever to lower drum



Foot pedal to raise drum



Code	Load Capacity (kg)	Ground / Pallet Clearance (mm)	Max Lift Height (mm)	Overall Size LxWxH (mm)	Unit Weight (kg)
V5160	350	350	575	920x1550x1520	168





# POPULAR FORKLIFT ATTACHMENTS AND LIFTING EQUIPMENT



**Cable Drum Stirrups**  
See Page 211



**Forklift Tine Hook**  
See Page 212

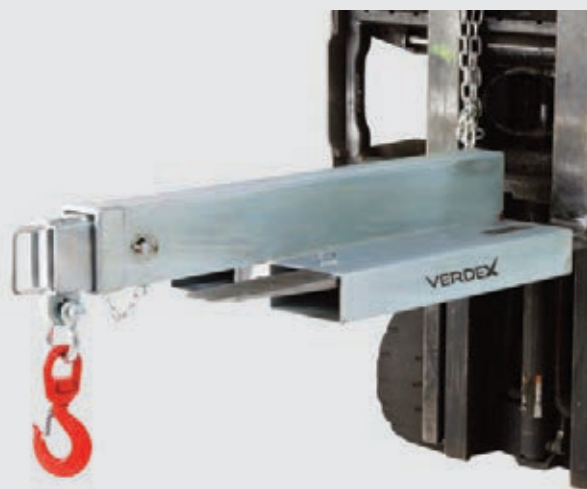

**Telescopic Short Jib**  
See Page 216



**Long Tilting Jib**  
See Page 217



**Fork Spreader**  
See Page 212



**Wheelie Bin Tipper**  
See Page 250



## Steel & Plastic Drum Lifter & Rotator

- This drum lifter can pickup and rotate drums with ease
- Manual foot or handle hydraulic pump for lifting
- Geared rotation using steering handle
- Worm drive handle for drum tilting



Code	Load Capacity (kg)	Lifting Height (mm)	Leg Length (mm)	Distance Between Inner Legs (mm)	Distance Between Outer Legs (mm)	Overall Size LxWxH (mm)	Unit Weight (kg)
V5106	450	1500	770	630	810	1400x1000x2100	190



## Electric Drum Lifter & Rotator

These electric drum lifters pickup and rotate drums using battery electric power for both up and down and for tilting.

- Suitable for both steel and plastic drums
- Lifting Speed: 120mm per second
- Rotation Speed: 180° - 30 seconds
- Battery: 12v, 120Ah



Code	Load Capacity (kg)	Max Lift Height (mm)	Leg Length (mm)	Distance Between Legs (mm)	Overall Size LxWxH (mm)	Unit Weight (kg)
V5150	450	2300	740	630	1600x950x1920	355





## Expanding Skate Conveyors

- Self tracking flexible expanding conveyor which expands from 1100mm to 4000mm
- Multiple units can be joined to make 1 continuous conveyor system
- Excellent for truck and container unloading and for assembly lines
- Easy and quick setup with adjustable height legs and brake castors on every leg
- Reduces manual handling
- Bolted steel construction with skate wheels



Watch a video of this in operation on our website here: [www.verdex.com.au/V3005](http://www.verdex.com.au/V3005)



Code	Width (mm)	Load Capacity Per Metre (kg)	Castors (mm)	Length Retracted (mm)	Length Expanded (mm)	Height Range (mm)	Unit Weight (kg)
V3005	460	100	125	1100	4000	690-1000	112
V3006	610	100	125	1100	4000	690-1000	124
V3007	760	100	125	1100	4000	690-1000	142

## Expanding Roller Conveyors

- The flexible expanding roller conveyor expands from 1500mm to 4000mm
- Multiple units can be joined to make 1 continuous conveyor system
- The roller conveyor is good for odd shaped cartons and bags of goods where the skate wheel conveyor wont work
- Easy and quick setup with height adjustable legs and brake castors on every leg
- Reduces manual handling
- Bolted steel construction with steel rollers
- 85mm gap between rollers



Watch a video of this in operation on our website here: [www.verdex.com.au/V3010](http://www.verdex.com.au/V3010)



Code	Width (mm)	Load Capacity Per Metre (kg)	Castors (mm)	Length Expanded (mm)	Length Retracted (mm)	Height Range (mm)	Unit Weight (kg)
V3010	460	130	125	4000	1500	690-1000	96
V3011	610	130	125	4000	1500	690-1000	116
V3012	760	130	125	4000	1500	690-1000	126





## Expanding Nylon Skate Conveyor

- Self tracking flexible conveyor which can expand from 1100mm to 4000mm
- Multiple units can be joined to make 1 continuous conveyor system
- Excellent for truck and container unloading and for assembly lines
- Easy and quick setup with adjustable height legs and brake castors on every leg
- Reduces manual handling
- Bolted steel construction with nylon skate wheels



Nylon Skate Wheel

Code	Width (mm)	Load Capacity Per Metre (kg)	Castors (mm)	Length Retracted (mm)	Length Expanded (mm)	Height Range (mm)	Unit Weight (kg)
V3041	610	75	105	1100	4000	690-1000	90

## Electric Expanding Roller Conveyors

- Simply plug in and go, this powered electric roller conveyor is great for carrying boxes and items up hill where gravity may not be achievable
- This conveyor is flexible and expands from 1500mm to 4000mm
- Multiple units can be joined to make 1 continuous powered conveyor system
- Great for loading and unloading containers
- Easy and quick setup with adjustable height legs and brake castors on every leg
- Quiet operation 240V AC motor with forward and reverse action and adjustable roller speed



Code	Width (mm)	Load Capacity Per Metre (kg)	Castors (mm)	Length Retracted (mm)	Length Expanded (mm)	Height Range (mm)	Unit Weight (kg)
V3030	460	140	125	1500	4000	690-1000	126
V3031	610	140	125	1500	4000	690-1000	131
V3032	760	140	125	1500	4000	690-1000	172



## Conveyor Components

Roller conveyors are one of the most common types of conveyors applied in conveying flat bottom type products. These kind of conveyors improve efficiency distribution & line links between different stages of production of your product.

### V3240

- Power coated Blue
- 40 Rollers = 75mm pitch between roller
- 20 Rollers = 150mm pitch between roller
- Frame Capacity: 200kgs / mtr

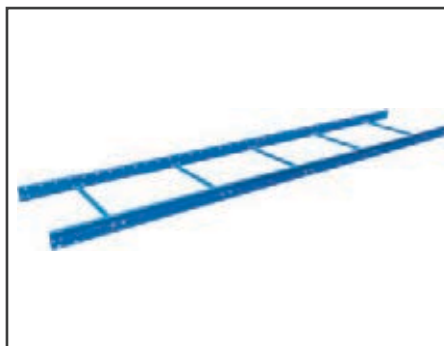

V3240 - Conveyor Frame

### V3140

- Power coated Blue
- Adjustable Height: 805-1105mm (includes frame)



V3140 - Conveyor Stand

### V3142

- Roller Size: 527x48mm
- Shaft Size: 10x8mm
- Spring Loaded Shaft
- Pre-Galvanized Tube 1.65mm Thick
- Capacity: 100kg / Roller
- 20 per carton



V3142 - 600mm Steel Rollers

### V3143

- Roller Size: 527x48mm
- Shaft Size: 10x8mm
- Spring Loaded Shaft
- Capacity: 20kg / Roller
- 20 per carton



V3143 - 600mm Poly Rollers



V3144 - 600mm Conveyor Gate



V3102 - Castor Kit to suit V3144



V3145 - Conveyor End Stop

Code	Description	Overall Size LxWxH (mm)	Unit Weight (kg)
V3240	Conveyor Frame - 600x3000mm (Rollers Sold Separately)	3000x660x80	19
V3140	Conveyor Stand to suit 600mm Frames	660x125x1015	8.5
V3142	600mm Galvanised Steel Rollers (20 Rollers per carton)	552x48	1.35
V3143	600mm Poly Rollers (20 Rollers per carton)	552x48	0.98
V3144	600mm Conveyor Gate (Steel Rollers only)	2025x660x1105	88
V3102	Castor Kit to suit V3144		2
V3145	Conveyor End Stop to suit V3144		



## Steel Roller Conveyor Kit (3 Metres long x 600mm wide)

Roller conveyors are one of the most common types of conveyors applied in conveying flat bottom type products such as cases, boxes, pallets & trays. These kind of conveyors improve efficiency distribution & line links between different stages of production of your product.

- Powdercoated Blue Frames and Legs
- Supplied with 40pcs Galvanised Steel Rollers
- Supplied with 3 Stands
- Can be joined together to make one continuous conveyor line
- Pitch: 75mm



Code	Details	Capacity (kg/M)	Adjustable Height (mm)	Overall Size LxWxH (mm)	Unit Weight (kg)
V3340	Steel Roller Conveyor Kit	200	805-1105	3000x660x1105	98
V3102	Castor Kit to suit V3340				
V3145	Conveyor End Stop to suit V3340				

## Poly Roller Conveyor Kit (3 Metres long x 600mm wide)

Roller conveyors are one of the most common types of conveyors applied in conveying flat bottom type products such as cases, boxes, pallets & trays. These kind of conveyors improve efficiency distribution & line links between different stages of production of your product.

- Can be joined together to make one conveyor line
- Supplied With 40pcs Poly Rollers
- Supplied With 3 Stands
- Pitch: 75mm
- Powdercoated Blue Frames and Legs



Code	Details	Capacity (kg/M)	Adjustable Height (mm)	Overall Size LxWxH (mm)	Unit Weight (kg)
V3341	Steel Roller Conveyor Kit	120	805-1105	3000x660x1105	88
V3102	Castor Kit to suit V3341				2
V3145	Conveyor End Stop to suit V3341				





## Forklift Sweeper Attachments

- The fork mounted sweeper is a quick and easy solution for reheapng products such as sand, top soil, grain or similar
- Equiped with ratchet straps to fasten securely on the forklift mast
- HCG: 205mm
- Fork Pocket Size: 218x44mm
- Fork Pocket Centre: 520mm

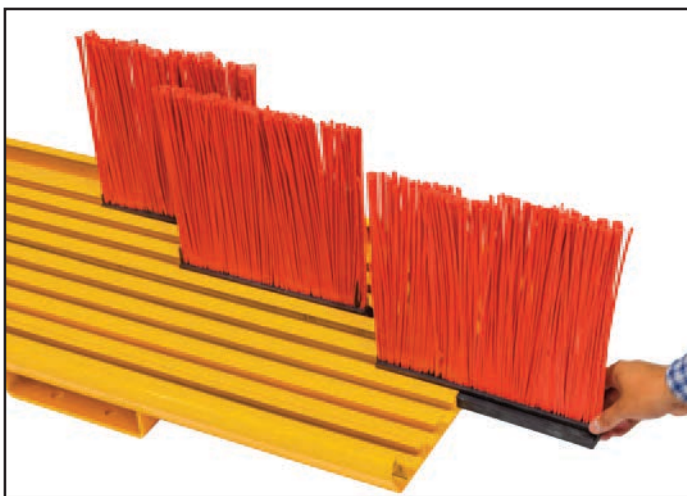
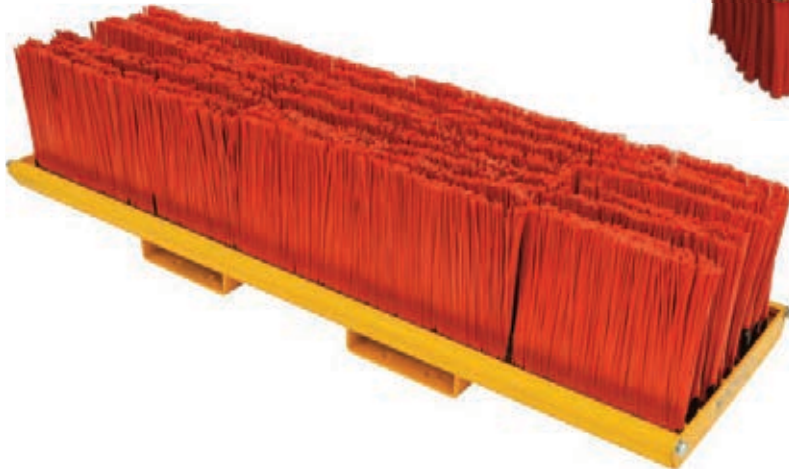

Bristle Rows: 8  
Bristle Height: 275mm



Code	Details	Overall Size LxWxH (mm)	Unit Weight (kg)
V6035	1500mm Forklift Sweeper	1500x465x326	75
V6036	1800mm Forklift Sweeper	1800x465x326	85



## Wet & Dry Vacuum Cleaners

- Industrial wet and dry vacuum cleaners
- Portable on wheel base with push handle
- Complete with all accessories
- Suitable for large workshops and factories
- Fitted with standard 10Amp 240V plug
- 70L Version supplied with push handle on trolley (V7000)



Code	Details	Motor (W)	Airflow (L/Sec)	Hose Length (mm)	Cable Length (mm)	Height (mm)	Unit Weight (kg)
V3000	30L Wet/Dry Vacuum Cleaner	1200	53	2500	7200	720	11
V7000	70L Wet/Dry Vacuum Cleaner	2000	106	2500	7200	980	24

## Manual Push Floor Sweeping Machine

- Ideal for sweeping factory floors, carpark, footpaths, entry ways etc.
- Independent rolling brushes prevent waste fallback
- Sweeper works by simply being pushed along which activates the roller and brushes
- Waste is picked up by the roller and brushes and pushed into the waste container located under the main cover
- Waste container is removable allowing for easy tipping into another bin



Watch a video of this in operation on our website here: [www.verdex.com.au/v9000](http://www.verdex.com.au/v9000)



Code	Waste Container Capacity (L)	Cleaning Width (mm)	Overall Size LxWxH (mm)	Unit Weight (kg)
V9000	40	920	1260x960x1040	23





# Cleaning Station Shadow Board Kit

This Shadow Board Kit is typically used in environments where ensuring cleanliness and organization is important. These areas include; food processing facilities, warehouses, manufacturing plants, and other industrial settings.

Improve workplace efficiency by keeping cleaning tools easily accessible with our Shadow Board

- Material : Aluminum UV Printed
- Supplied with 1 x V6403-Dust Mop, 1 x V6401 Industrial Broom with Squeegee, 1 x V6405 Large Dust Pan & Broom set and 1 x V6404 Large Dust Pan with Brush Set  
(See individual products on pages below)

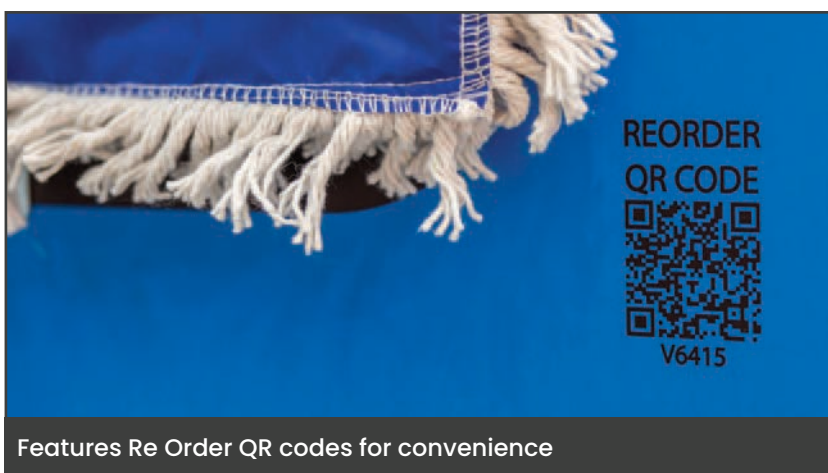

Features Re Order QR codes for convenience



Easily attaches to hooks

Code	Board Dimensions WxH (mm)	Unit Weight(kg)
V6414	1100x2100	18kg



Watch a video of this in operation on our website here: [www.verdex.com.au/V6414](http://www.verdex.com.au/V6414)







# POPULAR SAFETY PRODUCTS

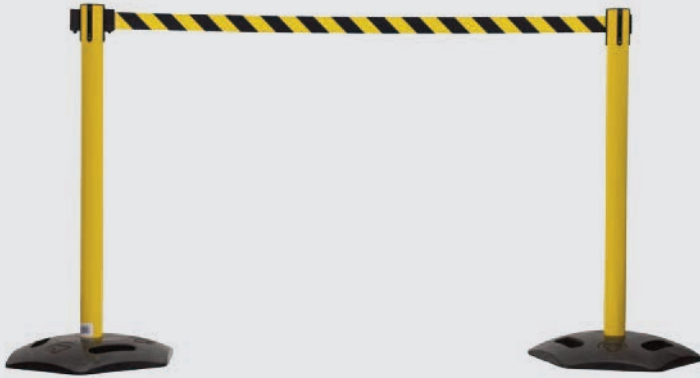

**Barrier Post**  
See Page 290



**Safety Tags**  
See Page 302

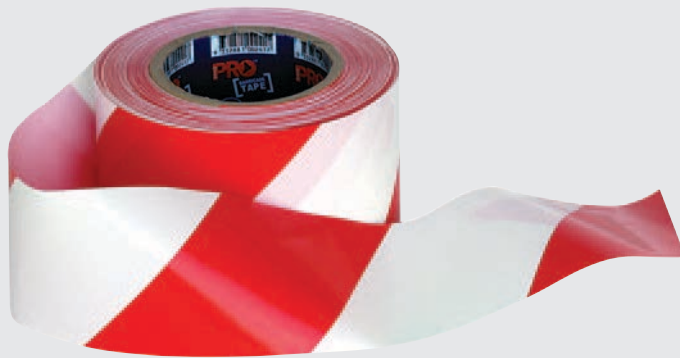

**Barricade Tape**  
See Page 297



**Safety Barrier**  
See Page 293



**Floor Marking Stickers**  
See Page 300



**Safety Gate & Sign**  
See Page 291

## Floor Brush with Squeegee

This set is extremely versatile, not only allowing you to sweep your workshop for debris and dust but to also scrub it for liquid spills etc.

- 600mm Floor brush with Squeegee
- Durable 25mm Powder coated Steel Handle
- 60mm long Synthetic Bristle



Code	Overall Size LxWxH (mm)	Unit Weight (kg)
V6401	590x100x1420	1.3

## Large Dustpan and Broom Set

This compact & versatile set can be easily accessible as freestanding or even folded & hung up for easy storage.

- Broom and Dustpan handles are made from Durable Powder Coated steel
- Broom head is constructed from durable polypropylene plastic
- Broom Handle: 20mm
- Dustpan Handle: 25mm
- 140mm long Synthetic Bristle
- Unit Weight: 1.8kg



Closed



Open

Code	Overall Size of Dustpan & Broom (mm)	Dustpan Folded Size (mm)	Dustpan Size in use (mm)	Opening Size (mm)	Broom Size (mm)
V6405	340x280x1350	320x130x1020	320x280x890	300x100	340x50x1215



## Dust Mop with Steel Handle

Our Dust Mop is a great cleaning solution suited for a variety of surfaces. It features a durable design with an aluminium powder coated handle & polyester fibres suitable for industrial applications.

The swivel head promotes easy maneuverability, allowing extra reach for those difficult spots.

- 900mm dust mop
- Durable 25mm Powder coated aluminum Handle
- Swivel head with polyester fibres



Code	Overall Size LxWxH (mm)	Unit Weight (kg)
V6403	900x160x1420	2.3

## Large Dustpan With Brush

The Verdex Large Dustpan with Brush is designed to provide an efficient and effective cleaning solution for a variety of environments, especially those with heavy debris.

- Broom Bristle Material: Polyethylene Terephthalate (PET)
- Dustpan Material: Polypropylene (PP)



Code	Overall Size LxWxH (mm)	Unit Weight (kg)
V6404	405x320x70	0.5



## X Shape Laundry Cart

- Lightweight trolley which is great for carting linen or waste
- Can be folded when not in use
- Strong vinyl bag
- Rubber castors - 4 x swivel
- Castors: 100mm
- Load Capacity: 100kg
- Volume Capacity: 150L

V9061 Replacement Bag



Code	Details	Overall Size LxWxH (mm)	Unit Weight (kg)
V9060	X Shape Laundry Cart	620x620x995	10
V9061	Replacement Bag to suit V9060		

## Plastic X Shape Laundry Cart

- Lightweight trolley which is great for carting linen or waste
- Easily remove the waste bag by unhooking from the frame
- Can be folded when not in use
- Strong vinyl bag
- Rubber castors - 4 x swivel
- Castors: 75mm
- Load Capacity: 60kg
- Volume Capacity: 178L
- Folded Size (LxWxH): 660x440x1100mm

V9071 Replacement Bag



Code	Details	Overall Size LxWxH (mm)	Unit Weight (kg)
V9070	Plastic X Shape Laundry Cart	690x660x950	10
V9071	Replacement Bag to suit V9070		

## 350L Waste Collection Bin

- Great for use in warehouses and on sites, for general waste and rubbish
- 2 front wheels and 1 rear wheel for easy wheeling throughout the workplace
- Pull handle which releases the bin forward



View video of this in operation here: [www.verdex.com.au/V6300](http://www.verdex.com.au/V6300)



Code	Front Wheel Size (mm)	Rear Wheel Size (mm)	Bin Capacity (L)	Safe Working Load (kg)	Bin Dimensions LxWxH (mm)	Unit Weight (kg)
V6300	340	125	350	350	1350x850x1040	72



## Plastic Bin Trolley (Blue)

- Heavy duty rotomoulded bin with 25mm steel tubular frame
- Bin is ribbed for extra strength
- Additional bins are available to purchase
- 280L Internal Top Dimension (WxL): 910x615mm
- 400L Internal Top Dimension (WxL): 1170x650mm
- 280L Height From Ground To Top Rim: 740mm
- 400L Height From Ground To Top Rim: 790mm
- Nylon castors - 2 x fixed, 2 x swivel
- Load Capacity: 400kg



Tub to suit



Bin Trolley

Code	Details	Internal Base Size (mm)	Overall Size LxWxH (mm)	Unit Weight (kg)
V1270B	Blue 280L Capacity Bin Trolley (Includes Bin)	-	1170x730x800	25
V1271	Blue 280L Capacity Tub	500x780	1030x730x600	8.5
V1273B	Blue 400L Capacity Bin Trolley (Includes Bin)	-	1400x710x850	44
V1274	Blue 400L Capacity Tub	1040x540	1280x780x640	12.6

## Plastic Bin Trolley (White)

- Heavy duty rotomoulded bin with 25mm steel tubular frame
- Bin is ribbed for extra strength
- Additional bins are available to purchase
- 280L Internal Top Dimension (WxL): 910x615mm
- 400L Internal Top Dimension (WxL): 1170x650mm
- 280L Height From Ground To Top Rim: 740mm
- 400L Height From Ground To Top Rim: 790mm
- Nylon castors - 2 x fixed, 2 x swivel
- Load Capacity: 400kg



Tub to suit



V1270W

V1273W

Code	Details	Internal Base Size (mm)	Overall Size LxWxH (mm)	Unit Weight (kg)
V1270W	White 280L Capacity Bin Trolley (Includes Bin)	-	1170x730x800	25
V1272	White 280L Capacity Tub	500x780	1030x730x600	8.5
V1273W	White 400L Capacity Bin Trolley (Includes Bin)	-	1400x710x850	44
V1275	White 400L Capacity Tub	1040x540	1280x780x640	12.6

## Round Plastic Waste Bins (Flat Lid)

- Plastic construction will not rust, chip or peel, resists dents.
- Double-ribbed base which increases stability and dragging capacity
- Reinforced rims add strength and durability
- Strong, snap-on lids allow for secure, stable stacking
- Built-in handles allow easy, non-slip lifting
- Tight-fitting indented lid design helps protect dry goods and other contents, while facilitating stacking during transportation and storage
- Quick and easy twist on, twist off dolly available to suit
- The dolly raises the bin overall height by 130mm
- Lid supplied with bin
- Colour: Grey
- V6310 Overall Height with Dollie: 745mm
- V6311 Overall Height with Dollie: 830mm
- V6312 Overall Height with Dollie: 930mm



Bin locks into  
dollie base



V6320



V6321



V6310



V6311



V6312

Code	Details	Overall Dia. Inc Handle (mm)	Dimensions DxH (mm)	Unit Weight (kg)
V6310	Round Plastic Waste Bin (80L Capacity)	555	505x615	4
V6311	Round Plastic Waste Bin (120L Capacity)	630	575x700	5
V6312	Round Plastic Waste Bin (168L Capacity)	700	620x800	7
V6320	Round Dollie to suit V6310	-	400 (D), 130 (H)	2
V6321	Round Dollie to suit V6311 & V6312	-	450 (D), 130 (H)	3





## Round Plastic Waste Bins (Swing Lid)

- Plastic construction will not rust, chip or peel, resists dents.
- Double-ribbed base which increases stability and dragging capacity
- Reinforced rims add strength and durability
- Strong, snap-on lids allow for secure, stable stacking
- Built-in handles allow easy, non-slip lifting
- Tight-fitting indented lid design helps protect dry goods and other contents, while facilitating stacking during transportation and storage
- Quick and easy twist on, twist off dolly available to suit
- The dolly raises the bin overall height by 130mm
- Lid supplied with bin
- Colour: Grey
- V6315 Overall Height with Dollie: 910mm
- V6316 Overall Height with Dollie: 1020mm



Code	Details	Overall Dia. Inc Handle (mm)	Dimensions DxH (mm)	Unit Weight (kg)
V6315	Round Plastic Waste Bin (80L Capacity)	555	505x780	4
V6316	Round Plastic Waste Bin (120L Capacity)	630	570x890	5
V6320	Round Dollie to suit V6315	-	400 (D), 130 (H)	2
V6321	Round Dollie to suit V6316	-	450 (D), 130 (H)	3



## Wheelie Bin Stands

- This wheelie bin security stands are great for securing your bins in public areas
- The stand is hot dip galvanised which is great for use in coastal areas
- The stands come standard with a lid restrictor and a spring loaded locking mechanism
- Supplied with one security allen key to open the locking mechanism
- Can be secured on the ground using (4) M12 dynabolts



Code	Details	Overall Size LxWxH (mm)	Unit Weight (kg)
V6380	Single Wheelie Bin Stand with Base Plate (120L)	395x250x1030	10.5
V6381	Double Wheelie Bin Stand with Base Plate (120L)	540x250x1030	12.5
V6382	Single Wheelie Bin Stand with Base Plate (240L)	395x250x1155	11
V6383	Double Wheelie Bin Stand with Base Plate (240L)	538x250x1255	13
V6384	Single Wheelie Bin Stand Inground (120L & 240L)	345x75x1425	9.5
V6385	Double Wheelie Bin Stand Inground (120L & 240L)	538x75x1425	11.5



# Foot Pedal Lifting Wheelie Bins

- These wheelie bins come supplied with a foot pedal operated lid which avoids touching the lid when disposing of waste
- Manufactured from high density polyethylene
- Resistant to decay, heat, frost, chemicals and UV rays
- Ideal for food preparation areas
- Available in Blue, Green and Grey
- Wheel Diameter: 200mm



Code	Details	Overall Size WxDxH (mm)	Unit Weight (kg)
V6340	Blue 120L Wheelie Bin (with foot pedal)	500x550x930	9.2
V6341	Green 120L Wheelie Bin (with foot pedal)	500x550x930	9.2
V6345	Blue 240L Wheelie Bin (with foot pedal)	590x740x1070	14.5
V6346	Green 240L Wheelie Bin (with foot pedal)	590x740x1070	14.5
V6347	Grey 240L Wheelie Bin (with foot pedal)	590x740x1070	14.5





## 70L Garbage Bins

- Small waste bins with four swivel castors
- Manufactured from high density polyethylene
- Resistant to decay, heat, frost, chemicals and UV Rays
- Available in four colours: Yellow, Blue, Grey and Green



Code	Details	Castors (mm)	Bin Capacity (L)	Overall Size WxDxH (mm)	Unit Weight (kg)
V6330	70L Garbage Bin (Yellow)	50	70	450x440x680	2.8
V6331	70L Garbage Bin (Blue)	50	70	450x440x680	2.8
V6332	70L Garbage Bin (Grey)	50	70	450x440x680	2.8
V6333	70L Garbage Bin (Green)	50	70	450x440x680	2.8

## Plastic Wheelie Bins

- Wheelie bins available in 2 standard sizes and 5 colours
- Manufactured from high density polyethylene
- Resistant to decay, heat, frost, chemicals and UV rays



Code	Details	Overall Size WxDxH (mm)	Unit Weight (kg)
V6350	Plastic Wheelie Bin (120L)	480x550x940	10
V6360	Plastic Wheelie Bin (240L)	580x730x1080	13

\*Bin colours available to order online



# Large Plastic Wheelie Bins

- Large plastic wheelie bins available in 2 standard sizes
- Choice of various bin and lid colours (green, blue, yellow, red)
- Manufactured from high density polyethylene
- Resistant to decay, heat, frost, chemicals and UV rays
- Wheel Diameter: 200mm
- V6361 Capacity: 660L
- V6362 Capacity: 1100L

### Bin Colours available:

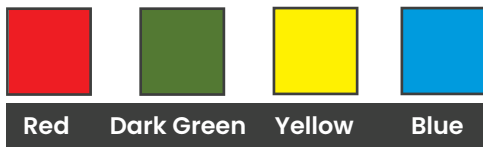

V6361B pictured



Code	Details	Wheel Base Size WxD (mm)	Overall Size WxDxH (mm)	Unit Weight (kg)
V6361	Large Plastic Wheelie Bin – Flat Lid (660L)	490x870	1310x775x1175	42
V6362	Large Plastic Wheelie Bin – Flat Lid (1100L)	750x880	1373x1073x1354	65



## Pull Cord Forklift Wheelie Bin Tippers

- These tippers are available for tipping 240 litre wheelie bins
- Simple and safe tipping operation
  - operated via a pull cord from the drivers seat
- The wheelie bin is firmly secured into position by the frame assembly preventing any bin movement, with the additional securing chain around the front of the bin. Returning the bin to the upright position can be done manually or with the forklift, the bin automatically locking into position once upright.
- 180 degree tipping operation
- Enamel painted finish



Watch a video of this in operation on our website here: [www.verdex.com.au/V6100](http://www.verdex.com.au/V6100)



Code	Bin Capacity (L)	Safe Working Load (kg)	Load Centre (mm)	Fork Pocket Size (mm)	Fork Pocket Centres (mm)	Unit Weight (kg)
V6100	1 x 240	500	1000	192x67	840	80

## Double Wheelie Bin Tipper Forklift Attachment

- Allows 180° rotation of one or two standard 240L plastic wheelie bins, simultaneously
- Ramp fitted for wheeling bins into position
- Safety chain and backrest used to secure bins in cradle
- Simple tipping action operated from forklift driver's seat
- Slip-on attachment allows quick connection to a forklift
- Can be configured to suit 120L plastic wheelie bins
- Suitable for manufacturing and general industry applications
- Zinc finish
- Load Centre: 1200mm



Code	Working Load Limit (mm)	Fork Pocket Size (mm)	Fork Pocket Centres (mm)	Unit Weight (kg)
V6103	1000	185x75	310	150





# Pull Cord Forklift Wheelie Bin Tipper

- This Tipper can empty a 660 litre and/or 1100 litre plastic wheelie bins by forklift, or an overhead crane.
- Allows 160° rotation of 660 or 1100 litre wheelie bins
- Suitable for operation with forklift or overhead cranes
- Pull cord tipping action activated at a safe distance by operator
- Shock absorber controls tipping forces
- Ratchet tensioners for simple and secure fastening of bin to attachment
- Enamel paint finish



Watch a video of this in operation on our website here: [www.verdex.com.au/v6101](http://www.verdex.com.au/v6101)



Code	Load Capacity (kg)	Overall Size WxDxH (mm)	Load Centre (mm)	Fork Pocket Size (mm)	Fork Pocket Centres (mm)	Unit Weight (kg)
V6101	500	1655x1200x1615	850	185x65	800	185



# Battery Electric Wheelie Bin Tipper

The Verdex Battery Electric Bin Tipper (with Remote) is everything a bin tipper should be - safe, economical & easy to use. Ideal for schools, factories, recycling centres and more.

- Rugged powder coated frame
- Wireless Remote Control, allowing user to control from a distance
- Indoor or outdoor use
- Lockout key and two-hand controls for safety
- Approximately 20 seconds to empty a bin
- Capable of tipping 2.5 tonnes of waste per charge
- If left plugged in on permanent charge, it can empty up to 10 tonnes per day
- Suits popular bin sizes 80L, 120L, 140L and 240L, with no adjustment
- Castors: 125mm, 2 with brakes
- Overall Height When Tipping: 2660mm



Wireless Remote - can be operated from a distance



View video of this in operation here [www.verdex.com.au/V6080](http://www.verdex.com.au/V6080)



Code	Lifting Capacity (kg)	Mast Height (mm)	Overall Size WxD (mm)	Tipping Height (mm)	Unit Weight (kg)
V6080	150	2485	1019x930	1600	137





# Battery Electric Wheelie Bin Tipper (Fully Enclosed)

The robust, fully enclosed Verdex bin tipper is the safest & most innovative unit of its kind. It comes standard with an 1800mm tipping height which is suitable for almost every environment & application. The unit is super efficient & incorporates an Auto Tip feature & can also be operated from a distance via a remote control hand piece.

For added safety it is fitted with interlocking doors to remove the risk of anything obstructing the cradle while in use. The Verdex Bin Tipper has a capacity of 250kg & the standard multi-purpose cradle is designed to accommodate 80, 120 & 240 litre bins.

- Achieves CAT 1 Safety Rating
- Power Supply: Battery with 240v built in charger
- 4 x 125mm swivel castors, 2 with brakes

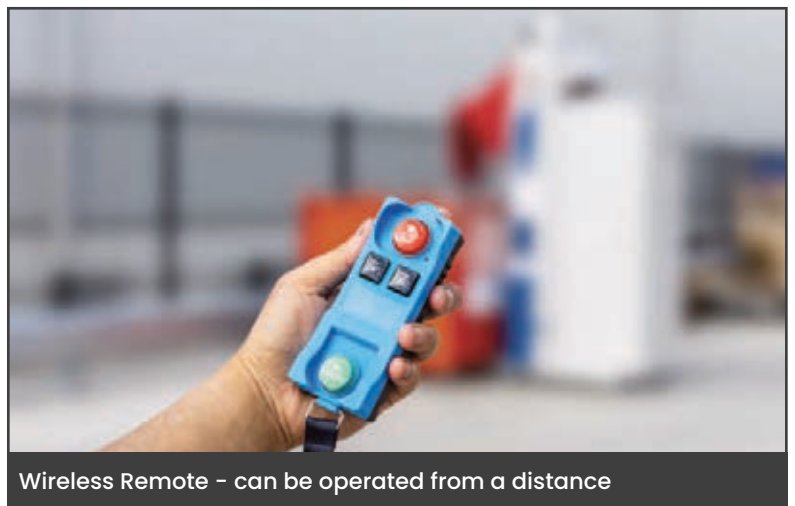

Wireless Remote - can be operated from a distance



View video of this in operation here [www.verdex.com.au/V6082](http://www.verdex.com.au/V6082)



Code	Lifting Capacity (kg)	Tipping Height (mm)	Overall Size LxWxH (mm)	Unit Weight(kg)
V6082	250	1800	1170x1025x2865	276





# Manual Wheelie Bin Tipper

The Verdex Manual Wheelie Bin Tipper is a robust and efficient solution for managing waste disposal. Designed for easy use, operators can effortlessly tip and empty wheelie bins without much effort. Ideal for both residential and commercial settings.

- Lifts 80L, 120L, 140L and 240L bins
- Heavy duty winch operated - no motorised pinch points!
- No electrical or hydraulic components to service
- Rugged powder coated frame for weather protection
- Overall Height: 2485mm



Code	Lifting Capacity (kg)	Mast Height (mm)	Overall Size WxD (mm)	Tipping Height (mm)	Unit Weight (kg)
V6083	65	2485	980x930	1600	136



# 660L Wheelie Bin with Rotator Base

- 60 litre wheelie bin suits high volume waste & recycling
- Fitted with rotator base allowing rotation by a forklift
- 4 swivel wheels, 2 fitted with brakes for manoeuvrability
- 2 large handles on each side
- Strong and sturdy design
- Smooth inner walls for ease in emptying & cleaning
- Resistant to acid, alkali, corrosion & durable to endure impact



Fork pockets for forklift attachment



View video of this in operation here [www.verdex.com.au/V6365](http://www.verdex.com.au/V6365)



Code	Capacity (L)	Dimensions LxWxH (mm)	Fork Pocket Size (mm)	Fork Pocket Centres (mm)	Unit Weight (kg)
V6365	660	1370x780x1240	160x60	365	72



## Forklift Crane Bins - 2T

- Heavy duty crane bins for all waste products
- These crane bins are space saving as they allow the bins to nest inside each other for transport and storage
- 2 tonne capacities
- Optional wheels available
- Crane hooks as standard
- Finish: Zinc plated
- Fork Pocket Size: 160x95mm (length), 160x75mm (width)



V1283 Wheel Kit to suit



Crane Hooks



V6046

V6047

V6045

Code	Details	Fork Pocket Centres (mm)	Overall Size WxLxH (mm)	Unit Weight (kg)
V6045	2 Tonne Fork/Crane Bin (850L)	450	1156x1156x1100	162
V6046	2 Tonne Fork/Crane Bin (1300L)	450	1716x1156x1100	240
V6047	2 Tonne Fork/Crane Bin (2500L)	790	2316x1516x1100	335
V1283	Wheel Kit to suit Crane Bins			

## Concrete Washout Bins

- Heavy-duty design with a waste pipe and air vent prevents blowout injuries & contains cement waste.
- Suitable for use with boom and line concrete pumps
- Can safely be used with compressed air & water line cleans
- Easily removable exhaust air vent for sponge recovery
- Lid secured to bin by safety chains in 4 points
- Bin Working Load Limit: 2000kg



Code	Details	Overall Size LxWxH (mm)	Unit Weight (kg)
V6053	Concrete Washout Bin (850L)	1290x1180x1350	242
V6054	Concrete Washout Bin (1350L)	1830x1185x1285	380
V6055	Concrete Washout Bin (2500L)	2330x1545x1320	600
V6057	Disposable Plastic Liner to suit 1350L Bin		
V6058	Disposable Plastic Liner to suit 2500L Bin		





## Forklift Tipping Bin - 150L

- This light weight fork waste bin is great for use in warehouses and on sites for general waste and rubbish
- Fitted standard with 2 front wheels and 1 rear wheel for easy wheeling throughout workplace
- Simply pull the cord or handle which releases mechanism for tipping into larger bins or skips
- Painted finish
- Polyurethane castors - 2 x fixed, 1 swivel with brake



Code	Castors (mm)	Load Capacity (kg)	Bin Capacity (L)	Fork Pocket Size (mm)	Fork Pocket Centres (mm)	Height to Top of Lip (mm)	Overall Size LxWxH (mm)	Unit Weight (kg)
V6000	125	500	150	140x55	600	710	1160x750x805	95

## Forklift Tipping Bins - 150L, 300L

- Great for use in warehouses & building sites for general waste & rubbish
- Available in painted yellow or galvanised
- Pull cord to release the mechanism for tipping into larger waste bins which saves the operator having to leave the forklift
- Safe Working Load: 350kg
- 150L & 300L Capacities available
- Fork Pocket Size: 140x65mm



View video of this in operation here:  
[www.verdex.com.au/v6070](http://www.verdex.com.au/v6070)



Code	Details	HCG (mm)	Fork Pocket Centres (mm)	Overall Size LxWxH (mm)	Unit Weight (kg)
V6070	150L Waste Tipping Bin (Yellow Painted)	402	600	970x750x820	90
V6071	300L Waste Tipping Bin (Yellow Painted)	451	800	1065x950x960	116
V6075	150L Waste Tipping Bin (Galvanized)	402	600	970x750x820	90
V6076	300L Waste Tipping Bin (Galvanized)	451	800	1065x950x960	116



## Forklift Rollover Tipping Bin – 1100L (with Release Mechanism)

- The Forklift rollover tipping bin with a release mechanism attaches to forklifts and is used to safely transport and unload bulk materials.
- It's commonly used in waste management, recycling, construction, and manufacturing for handling materials like scrap, debris, or loose loads.
- The release mechanism allows for controlled tipping, improving efficiency and safety by reducing manual handling.
- Finish: Hot Dipped Galvanised



Code	Capacity (L)	Working Load Limit (mm)	Overall Size LxWxH (mm)	Unit Weight (kg)
V6115	1100	1200	1665x1220x1040	180

## Forklift Tipping Bins – 350L, 460L

- This light weight fork waste bin is great for use in warehouses and on sites for general waste
- Fitted standard with 2 front wheels and 1 rear wheel for easy wheeling throughout workplace
- Manual push over for tipping into larger bins or skips
- Drain plug fitted as standard
- Hot Dipped Galvanised



Watch a video of this in operation on our website here: [www.verdex.com.au/V6005](http://www.verdex.com.au/V6005)



Code	Details	SWL (kg)	Fork Pocket Size (mm)	Fork Pocket Centres (mm)	Overall Size WxDxH (mm)	Unit Weight (kg)
V6005	Fork Waste Bin (350L Capacity)	350	140x65	367	720x1115x890	65
V6006	Fork Waste Bin (460L Capacity)	650	140x65	367	1000x1115x890	90



## Forklift Tipping Bin - 1100L (with Release Mechanism)

- These heavy duty tipping bins are ideal for heavy waste including metal, timber and building site rubble
- The tipping release mechanism is activated by the forklift operator pulling the pull cord from the drivers seat - the custom built shock absorber prevents impact forces being transmitted to the forklift when emptying
- Fitted with a Drain Plug
- Finish: Galvanised



V6013 Wheel Kit



Watch a video of this in operation on our website here, [www.verdex.com.au/V6023](http://www.verdex.com.au/V6023)



Code	Details	Bin Capacity (L)	Safe Working Load (kg)	Overall Size LxWxH (mm)	Fork Pocket Size (mm)	Fork Pocket Centres (mm)	Unit Weight (kg)
V6023	1100L Tipping Bin	1100	1000	1625x1140x1005	170x70	635	210
V6013	Wheel Kit to suit 1100L Tipping Bin						

## Forklift Bin Compactor - 1T

- Used to compact bulky waste products using a forklift
- Suitable for use with a 660L wheelie bin or any larger bins
- Eliminates the unsafe practice of treading down loose waste
- Slip-on attachment and safety chain for quick connection to forklift
- Increased bin capacity helps lower waste removal costs
- Finish: Hot Dipped Galvanised



Fork Pockets



Safety Chain



Watch a video of this in operation on our website here: [www.verdex.com.au/V6105](http://www.verdex.com.au/V6105)



Code	Load Centre (mm)	Height (mm)	Counterweight Dimensions WxD (mm)	Fork Pocket Size (mm)	Fork Pocket Centres (mm)	Unit Weight (kg)
V6105	830	1300	900x500	185x65	650	1000





## Forklift Tipping Bins – 950L, 1250L, 1850L

- These large self dumping tipping bins are suitable for any waste and rubbish application
- Heavy duty construction with self dumping ability, the forklift empties the bin without the operator leaving the drivers seat
- Supplied with 4 crane lugs (top) and 2 upending lugs (underneath)
- Available in 3 standard sizes
- Optional wheel kit available
- Hot Dipped Galvanised



Optional Wheel Kit Available



Crane Lifting Lugs



Crane Lifting Lugs



Watch a video of this in operation on our website here: [www.verdex.com.au/V6010](http://www.verdex.com.au/V6010)



Code	Details	SWL (kg)	Fork Pocket Size (mm)	Fork Pocket Centres (mm)	Overall Size WxLxH (mm)	Unit Weight (kg)
V6010	Self Dumping Tipping Bin (950L)	1500	185x75	380	1570x1010x1080	164
V6011	Self Dumping Tipping Bin (1250L)	1500	185x75	680	1570x1305x1080	188
V6012	Self Dumping Tipping Bin (1850L)	1500	185x75	680	1570x1905x1080	255
V6013	Wheel Kit to suit Tipping Bins (includes 4 wheels)					



## Craneable Storage Bin

These Storage Bins are available in two sizes and have been designed for the secure handling of parts in and around your workshop and during transport.

- Durable Zinc Plated finish
- Easily transported by forklift or crane and are stackable up to 4 high when fully loaded.
- Stackable 4 high when fully loaded.
- Features Crane Lifting lugs fitted as standard
- Optional, lockable lid available for securing on-site tools or smaller equipment



Code	Details	Working Load Limit (kg)	Overall Size LxWxH (mm)	Unit Weight (kg)
V7568	Craneable Storage Bin (580L)	1000	1150x1150x776	115
V7569	Optional Lockable Lid to suit	-	1020x1020x130	27





## 500L Drop Bottom Bin (Solid Sides)

The heavy-duty Drop Bottom Bin is designed for the efficient storage and transfer of waste materials. This bin is emptied via a simple drop bottom base, allowing complete emptying of contents into a larger bin or dump truck. The base is closed by an automatic locking mechanism when bin is lowered to the ground.

- Drop bottom base allows fast and complete dumping of solid waste
- Heavy-duty 3mm reinforced plate to handle all waste products
- Easily transported by forklift or overhead crane
- Drop bottom base is released safely from driver's seat via a pull cord mechanism
- Powerful shock absorbing system removes all impact from the forklift or crane during emptying
- Crane lugs fitted as standard
- Optional wheel kit available for supply
- Enamel paint finish



Code	Volume (L)	Safe Working Load (kg)	Bin Dimensions LxWxH (mm)	Fork Pocket Size (mm)	Fork Pocket Centres (mm)	Unit Weight(kg)
V6042	500	1000	1200x1025x745	165x65	684	200

## 1500L Drop Bottom Bin (Solid Sides)

- These drop bottom bins are a heavy duty bin made for all types of waste
- This bin is able to be transported either by forklifts or cranes
- Emptying is carried out by pulling the draw rope handle which allows the floor to drop open from one side allowing complete emptying
- Sheet metal sides and base
- Durable Zinc finish



View video of this in operation here: [www.verdex.com.au/v6040](http://www.verdex.com.au/v6040)



Code	Volume (L)	Safe Working Load (kg)	Bin Dimensions LxWxH (mm)	Fork Pocket Size (mm)	Fork Pocket Centres (mm)	Unit Weight (kg)
V6040	1500	1000	1540x950x1350	165x50	784	200





# 1500L Drop Bottom Bin (Mesh Sides)

- These drop bottom bins are a heavy duty bin made for all types of waste
- Ideally suited to the recycling industry, the cage can be lifted by either a forklift or crane
- This bin is able to be transported either by fork lifts or cranes
- Emptying is carried out by pulling the draw rope handle which allows the floor to drop open from one side allowing complete emptying
- Mesh sides with sheet metal base



View video of this in operation here: [www.verdex.com.au/v6041](http://www.verdex.com.au/v6041)



Code	Volume (L)	Safe Working Load (kg)	Bin Dimensions LxWxH (mm)	Fork Pocket Size (mm)	Fork Pocket Centres (mm)	Unit Weight(kg)
V6041	1500	1000	1540x950x1350	165x50	784	158





## 1000L IBC Tank & Frames

These Bulk Storage Containers are designed for the safe storage, transport and dispensing of bulk materials and liquids.

- Steel Galvanised Frame
- Two versions available; Food & Industrial Grade

### V7684

- Not suitable for use with Dangerous Goods
- Food safety according to FSSC 22000 + declaration of conformity
- Supplied with Outlet valve integr.butterfly-valve DN50/2"
- Inlet: Screw cap DN150 / 6", PE-HD

### V7686

- Is Industrial Grade Dangerous Goods approved
- Supplied with Outlet valve integr.butterfly-valve DN50/2"
- Inlet: Screw cap DN150 / 6", PE-HD,

### Tilting Stands for IBC Containers

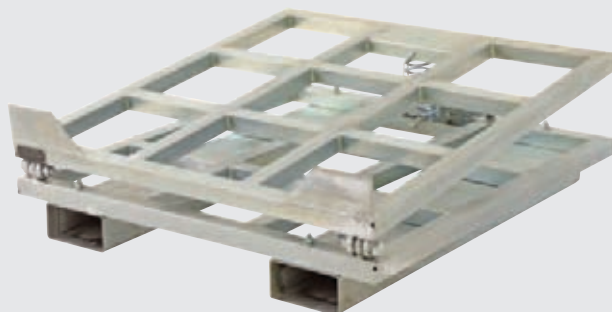

See page 271



V7684



V7686

Code	Details	Bund Capacity (L)	Overall Size LxWxH (mm)	Unit Weight (kg)
V7684	Food Grade IBC Tank & Frame	1000	1200x1000x1160	53
V7686	Industrial DG Grade IBC Tank & Frame	1000	1200x1000x1160	55.4



## 4 Drum Bunded Spill Pallet

- Heavy duty bunded pallets made from UV stabilised polyethylene
- Removable grate and nestable when not in use for easy storage
- Holds up to 4x 205L Drums
- Easy 4 way forklift and pallet truck entry
- Corrosion Resistant
- Complies with safety standard & EPA requirements
- Complies with AS4326-2008, AS2714-2008, AS/NZS-4452-1997, AS3780-2008



Code	Spill Capacity (L)	Overall Dimensions WxDxH (mm)	Unit Weight (kg)
V7673	250	1300x1300x300	32

## Single & Double IBC Bunded Pallets

- Heavy duty bunded pallets made from UV stabilised polyethylene
- Removable grate and nestable when not in use for easy storage
- Easy forklift and pallet truck entry
- Corrosion Resistant
- Complies with safety standard and EPA requirements
- Complies with AS4326-2008, AS2714-2008, AS/NZS-4452-1997, AS3780-2008
- SWL: 3000kg (static)

*\*Please Note: The IBC Containers are not included*



V7677 pictured with IBC Container\*



V7678 pictured with 2 x IBC Containers\*



V7677



V7678

Code	Details	Bund Capacity (L)	Overall Size LxWxH (mm)	Unit Weight (kg)
V7677	Single IBC Bunded Pallet	1300	1350x1350x900	71
V7678	Double IBC Bunded Pallet	1100	2200x1300x500	96



## IBC Galvanised Spill Bin

- These Galvanised spill bins have been specifically designed for IBC's and suit most IBC's available
- The close spacing support bars allow protection of the IBC frame
- Easy forklift and pallet truck entry
- These spill bins have a spill capacity exceeding Australian Government regulations of 125% containment of the IBC



Code	SWL (kg)	Bund Capacity (L)	Overall Dimensions LxWxH (mm)	Unit Weight (kg)
V7585	2500	1250	1456x1456x830	195

## Galvanised 4 Drum Spill Bin

- This pallet racking friendly spill bin is designed for storage of up to 4 standard 205 litre bins and can be transported by forklift or pallet trolley.
- Suits 4 x 205 litre drums
- Close spacing support bars allows direct placement of large or small drums
- Timber pallets may be fitted within the raised skirt if required
- Fitted with a drain plug to empty the containment area
- Elevated base allows transport by forklift or pallet trolley
- Steel fabricated, non-flammable unit
- Provides a spill capacity exceeding Australian Standards for 'portable' units
- Long life galvanised finish

*\*Please Note: The Drums are not included*



Code	Load Capacity (kg)	Spill Capacity (L)	Fork Pocket Size (mm)	Fork Pocket Centres (mm)	Overall Dimensions WxDxH (mm)	Unit Weight (kg)
V7582	2000	245	245x80mm / 180x80	450/910	1210x1210x265	70





## Galvanised 1 Drum Spill Bin

- Suits 1 x 205 litre drum
- Close spacing support bars allows direct placement of large or small drums
- Fitted with a drain plug to empty the containment area
- Elevated base allows transport by forklift or hand pallet jack
- Steel fabricated, non-flammable unit
- Provides a spill capacity exceeding Australian Standards for 'portable' units
- Long life galvanised finish

\*Please Note: The Drums are not included



Code	Load Capacity (kg)	Spill Capacity (L)	Overall Dimensions WxDxH (mm)	Unit Weight (kg)
V7580	2000	240	810x760x490	55

## Galvanised 2 Drum Spill Bin

- This Spill Bin provides complete protection against costly and environmentally damaging chemical spills from leaking drums.
- Suits 2 x 205 litre drums
- Close spacing support bars allows direct placement of large or small drums
- Fitted with a drain plug to empty the containment area
- Elevated base allows transport by forklift or hand pallet jack
- Steel fabricated, non-flammable unit
- Provides a spill capacity exceeding Australian Standards for 'portable' units
- Long life galvanised finish

\*Please Note: The Drums are not included

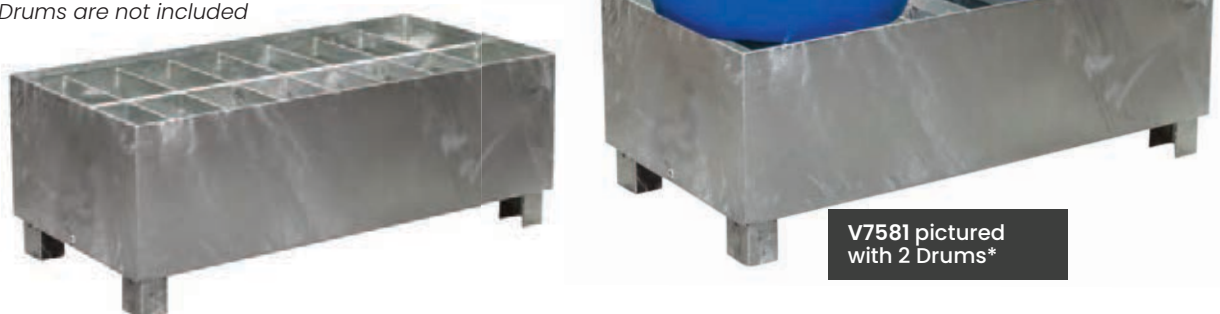

Code	Load Capacity (kg)	Spill Capacity (L)	Overall Dimensions WxDxH (mm)	Unit Weight (kg)
V7581	2000	250	1210x610x440	60

# POPULAR CONSTRUCTION PRODUCTS



**Bulk Bag Filling Frame**  
See Page 169



**Rigging Storage Rack**  
See Page 170



**Site Tool Box**  
See Page 173



**Concrete Mould**  
See Page 167



## Spring Loaded Tilting Stand

- These clever yet simple spring loaded tilting stands are designed making it easy to decant from IBC bulk storage containers.
- The hinged platform raises to a 10 degree angle as the weight decreases.
- Sits on a base with bolt on fork pockets which can be removed if required
- Easy to move with a forklift
- Simple and easy-to-use
- Finish: Zinc Plated
- Load Centre: 600mm



Code	Details	Load Capacity (kg)	Fork Pocket Centres (mm)	Fork Pocket Size (mm)	Platform Size (mm)	Overall Size LxWxH (mm)	Unit Weight (kg)
V7680	Tilting Stand	2000	730	190x90	1200x1130	1130x1200x360	105
V7681	Extra Spring for V7680						

## Spring Loaded Drum Tilter

- 10° tilt allows decanting directly from a standard 205L drum
- Tie down points allow drum to be secured for transport and storage
- Fork pockets fitted for easy handling and positioning around the workplace by forklift
- Designed for storage in pallet racking
- Zinc finish



Code	Load Capacity (kg)	Overall Size LxW (mm)	Unit Weight (kg)
V7579	500	900x400	30





# Single and Double Cylinder Trolleys

## V1210 & V1211

- These gas cylinder trolleys are available for transporting either 1 or 2 cylinders
- Heavy duty solid rubber wheels
- V1210: 200mm rubber wheels
- V1211: 390mm rubber wheels
- Supplied with securing chains as pictured

## V7635

- The V7635 gas cylinder rack can be bolted to the wall for secure storage of gas cylinders
- These Gas Cylinder racks mount to a wall for safe storage of 2 size 'G' gas bottles
- The base has a sloped front for easy trolley access
- Supplied with safety chain to secure bottles



Securing Chains



V1210

V1211

V7635

Code	Details	Castors (mm)	Cylinder Size Dia. (mm)	Overall Size WxDxH (mm)	Unit Weight (kg)
V7635	Gas Cylinder Rack	-	140-250 x 2	540x350x1000	18
V1210	Single Cylinder Trolley	200	140-250	600x600x1360	17
V1211	Double Cylinder Trolley	390	140-250 x 2	700x700x1380	44



## Galvanised Drum Trolley with Bund

- This trolley is designed to carry 1 drum which is mounted on the rack provided for easy dispensing
- The bin tray has a drain plug for draining the bin
- Finish: Galvanised

Bunded Trolley is *not* supplied with the drum



Code	Spill Bin Capacity (L)	Overall Size WxDxH (mm)	Unit Weight (kg)
V7583	230	610x1210x431	90

## Gas Cylinder Cage

- Designed to safely store and transport gas cylinders by forklift or overhead crane
- 4 crane lifting lugs at top & 2 forklift pockets underneath for easy transport
- Ideal for use on building sites and mines
- Suitable for many different sized cylinders
- Load binder allows cylinders to be securely fastened in position
- Folding ramp for easy access, reducing unsafe lifting of cylinders by personnel
- Stacks two high when fully loaded
- Crane Working Load Limit: 500kg



Code	Fork Working Load Limit (kg)	Fork Pocket Centres (mm)	Fork Pocket Size WxH (mm)	Overall Size WxDxH (mm)	Internal Size WxD (mm)	Unit Weight (kg)
V7602	1000	600	192x92	1200x850x1065	1050x700	120



# Universal, Chemical, Oil & Fuel Spill Kits

Emergency response Spill Kits contain a premium range of bioactive absorbents providing rapid and effective clean up of hazardous chemical, oil, hydrocarbon or water based liquid spills

### Selection Guide

- UNIVERSAL** Clean-up of most liquids used in factories and workshops.
- CHEMICAL** Clean-up of aggressive liquids. Suitable for most chemical spills
- OIL & FUEL** Clean-up of oils, fuels and other non-water soluble liquids. Not suitable for water based liquids



Please Note: Image shown is the universal kit

#### Universal 40L Components

Content: 1 x 1.2m absorbent minibooms, 20 x 410mm x 460mm absorbent pads, 1 x 5kg MaxSorb premium floorsweep, 1 x elbow length PVC gloves, 1 x printed disposal bag, 1 x PVC labelled carry bag, 1 x product instruction sheet including re-order form

#### Chemical 40L Components

Content: 1 x 1.2m absorbent minibooms, 20 x 410mm x 460mm absorbent pads, 1 x 5kg MaxSorb premium floorsweep, 1 x elbow length PVC gloves, 1 x printed disposal bag, 1 x PVC labelled carry bag, 1 x product instruction sheet including re-order form

#### Oil & Fuel 40L Components

Content: 1 x 1.2m absorbent miniboom, 20 x 410mm x 460mm absorbent pads, 1 x 5kg MaxSorb premium floorsweep, 1 x elbow length PVC gloves, 1 x printed disposal bag, 1 x PVC labelled carry bag, 1 x product instruction sheet including re-order form



Please Note: Image shown is the universal kit

#### Universal 120L Components

Content: 3 x 3.0m absorbent minibooms, 50 x 410mm x 460mm absorbent pads, 1 x 10kg MaxSorb premium floorsweep, 1 x industrial brush & pan set, 1 x elbow length PVC gloves, 2 x printed disposal bags, 1 x 120L labelled wheelie bin, 1 x product instruction sheet including re-order form

#### Chemical 120L Components

Content: 3 x 3.0m absorbent minibooms, 50 x 410mm x 460mm absorbent pads, 1 x 10kg MaxSorb premium floorsweep, 1 x industrial brush & pan set, 1 x elbow length PVC gloves, 4 x printed disposal bags, 1 x 120L labelled wheelie bin, 1 x product instruction sheet including re-order form

#### Oil & Fuel 120L Components

Content: 3 x 3.0m absorbent minibooms, 50 x 410mm x 460mm absorbent pads, 1 x 10kg MaxSorb premium floorsweep, 1 x industrial brush & pan set, 1 x elbow length PVC gloves, 4 x printed disposal bags, 1 x 120L labelled wheelie bin, 1 x product instruction sheet including re-order form



Please Note: Image shown is the universal kit

#### Universal 240L Components

Content: 7 x 3.0m absorbent minibooms, 100 x 410mm x 460mm absorbent pads, 1 x 10kg MaxSorb premium floorsweep, 1 x industrial brush & pan set, 1 x elbow length PVC gloves, 4 x printed disposal bags, 1 x 240L labelled wheelie bin, 1 x product instruction sheet including re-order form

#### Chemical 240L Components

Content: 7 x 3.0m absorbent minibooms, 100 x 410mm x 460mm absorbent pads, 1 x 10kg MaxSorb premium floorsweep, 1 x industrial brush & pan set, 2 x elbow length PVC gloves, 8 x printed disposal bags, 1 x 240L labelled wheelie bin, 1 x product instruction sheet including re-order form

#### Oil & Fuel 240L Components

Content: 7 x 3.0m absorbent minibooms, 100 x 410mm x 460mm absorbent pads, 1 x 10kg MaxSorb premium floorsweep, 1 x industrial brush & pan set, 2 x elbow length PVC gloves, 8 x printed disposal bags, 1 x 240L labelled wheelie bin, 1 x product instruction sheet including re-order form

Code	Details	Absorbent Capacity (L)	Dimensions LxWxH (mm)	Packaging	Unit Weight (kg)
V7641	Universal Spill Kit	40	500x200x450	PVC Carry Bag	6
V7642	Universal Spill Kit	120	500x500x950	120L Wheelie Bin	32
V7643	Universal Spill Kit	240	700x600x2050	240L Wheelie Bin	52
V7644	Chemical Spill Kit	40	500x200x450	PVC Carry Bag	8
V7645	Chemical Spill Kit	120	500x500x950	120L Wheelie Bin	32
V7646	Chemical Spill Kit	240	700x600x1050	240L Wheelie Bin	52
V7647	Oil & Fuel Spill Kit	40	500x200x450	PVC Carry Bag	6
V7648	Oil & Fuel Spill Kit	120	500x500x950	120L Wheelie Bin	32
V7649	Oil & Fuel Spill Kit	240	700x600x1050	240L Wheelie Bin	42

To order refill kits, please add 'K' to the end of the code number, eg V7642K





## Safety Cabinets for Corrosive Goods

- Heavy duty 1.2mm double skin wall construction, with 40mm air gap to provide thermal insulation
- Self closing door mechanism, with three point lock.
- Double door cabinets right door can be set a 7 locking positions between 20 and 90° for easy access
- Fully welded deep liquid tight sump
- Recessed handle with key lock, that can be opened from inside.
- Designed to comply with relevant Australian Standards
- All safety signage included



V7690 – 30L Corrosive Goods Cabinet



V7691 – 60L Corrosive Goods Cabinet



V7692 – 100L Corrosive Goods Cabinet



V7693 – 160L Corrosive Goods Cabinet



V7694 – 250L Corrosive Goods Cabinet

Code	Details	Internal Size HxWxD (mm)	External Size HxWxD (mm)	Number of Shelves	Unit Weight (kg)
V7690	Safety Cabinets For Corrosive Goods (30L Capacity)	535x425x375	805x520x475	1	53
V7691	Safety Cabinets For Corrosive Goods (60L Capacity)	800x425x375	1070x520x475	2	62
V7692	Safety Cabinets For Corrosive Goods (100L Capacity)	560x835x530	810x935x680	1	100
V7693	Safety Cabinets For Corrosive Goods (160L Capacity)	1045x1015x375	1295x1115x525	2	138
V7694	Safety Cabinets For Corrosive Goods (250L Capacity)	1580x1015x475	1830x1115x525	3	187

## Flammable Liquid Safety Cabinets

- High quality construction using zinc coated steel sheeting
- Powder coat finish giving high resistance to splashes and spills
- All products designed to comply with Australian Standards and relevant Dangerous Goods Regulations
- All cabinets supplied inclusive of all relevant safety signage and decals
- Adjustable slow release user friendly hydraulic door control closure systems
- Stainless steel continuous pin hinging for reliable and accurate door closing
- Adjustable and removable shelves



Code	Storage Capacity (L)	Door Opening Size (mm)	Internal Size LxWxH (mm)	External Size LxWxH (mm)	Unit Weight (kg)
V7650	30	420x555	420x375x555	505x465x800	43
V7651	60	420x820	420x375x820	505x465x1065	55
V7652	100	835x555	835x525x555	920x615x800	76
V7653	160	1015x1050	1015x375x1050	1100x465x1295	110





# 250L Flammable Liquid Safety Cabinet



Sequential self closing doors

Removable and adjustable shelves

Continuous hinges for extra strength

Deep Liquid Tight Sump for containment of leakage or spillage

Durable and chemical resistant, lead-free powder coat is painted inside and outside cabinets, minimizing the effects of corrosion and humidity



Cabinet sits on feet to make it easy for cleaning underneath



Recessed door handle with lock



Sequential Self Closing Doors



Adjustable and removable shelves

Code	Storage Capacity (L)	4L Drum Capacity	20L Drum Capacity	Number of Shelves	Internal Size LxWxH (mm)	External Size LxWxH (mm)	Unit Weight (kg)
V7610	250	70	9	3	1015x410x1605	1100x500x1850	165





## Lockable Storage Cage

- Secure gas cylinder cage, suitable for workshops, building sites and mines
- The cage is fitted with crane lifting lugs and fork pockets underneath
- Cage comes with securing load straps to prevent cylinders from moving during transport
- Full metal roof which provides weather protection
- Padlockable for security purposes
- Finish: Zinc plated
- Lockable door
- Load Centre: 515mm
- HCG: 600mm



V7600



V7600 pictured with 3 x V7603



Ratchet strap supplied



V7601 Ramp to suit V7600

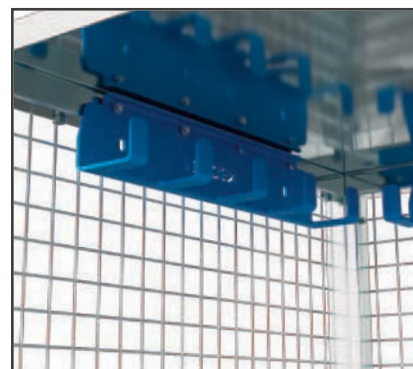

V7603 pictured in V7600

Code	Details	Safe Working Load(kg)	Fork Pocket Size (mm)	Overall Size WxDxH (mm)	Internal Size WxDxH (mm)	Unit Weight (kg)
V7600	Storage Cage	750	165x65	1060x1060x1900	930x930x1850	180
V7600A	Assembly of Lockable Storage Cage Available					
V7601	Ramp to suit V7600			500x1015x40	-	13
V7603	Rigging Hanging Rack to suit V7600		-	930x100x220	-	5



## Lockable Mesh Storage Cage

- Lockable mesh storage cage is designed for strength, visibility and ventilation
- Ideal for use in workshops, warehouses, construction sites and industrial applications
- Can be bolted to the ground for additional security
- Key Lockable for safe and secure storage
- Supplied with 3 adjustable shelves
- Shelf capacity: 200kg
- Powder coated finish



Code	Details	Load Capacity (kg)	Mesh Size (mm)	Overall Size WxDxH (mm)	Internal Size WxDxH (mm)	Unit Weight (kg)
V7550	Storage Cage	600	50x50	1150x450x1800	1050x390x1770	70
V7550A	Assembly of Lockable Mesh Storage Cage					

## Mesh Storage Cage (with shelves)

- The Mesh Storage Cage's unique design incorporates a left or right opening gate which is totally removable if required.
- Comes complete with three removable shelves and a forklift accessible base for easy transportation.
- Spacing between shelves: 420mm
- Reversible opening gate
- Longlife durable zinc finish
- Optional castor kit - 100mm castors (2 fixed & 2 swivel)
- Mesh Size: 50x50mm

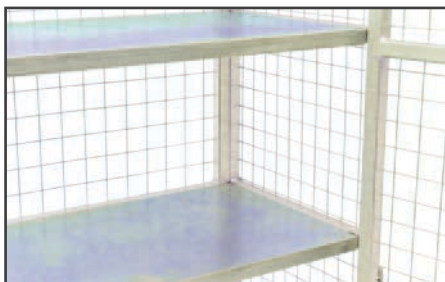

V7606 - Castor Kit



Code	Details	Working Load Limit (kg)	Load Capacity (kg)	Overall Size WxDxH (mm)	Unit Weight (kg)
V7605	Mesh Storage Cage with shelves	500	1000	1160x580x1985	145
V7605A	Assembly of Mesh Storage Cage Available				
V7606	Castor Kit to suit V7605				





## Gas Cylinder Cage

Heavy duty lockable cage suited for storage of up to 24 x 9kg BBQ gas bottles but can be used for many other storage applications including firewood at service stations where easy access and excellent security is a requirement.

- Tamper-proof lock guard prevents cutting of the padlock by bolt cutters, along with anti-tamper gate hinges
- Sturdy construction with bump rails protecting the mesh sides
- Stack 3 high when empty and 2 high when fully loaded
- Bolted mid shelf can be excluded during construction for storage of 18kg forklift gas bottles
- Sheet metal shelves allow easy sliding of cylinders to the back of the cage.
- Sheet metal roof provides weather protection
- Forklift provision is provided under the cage for transport around worksite
- Zinc finish for long life corrosion protection
- Distance between Shelves: 540mm



Padlockable



Code	Details	Load Limit (kg)	Internal Size LxWxH (mm)	Overall Size LxWxH (mm)	Unit Weight (kg)
V7555	Gas Cylinder Cage	500	1960x670x1100	2040x760x1285	200
V7555A	Assembly of Gas Cylinder Cage Available				





## Forklift Gas Storage Cages

- Heavy duty steel construction storage cages specifically designed for storage of LPG cylinders used on forklifts
- Power coated green
- Cylinder chain restraint
- All cages have padlockable doors for increased safety
- Designed to comply with relevant Australian Standards
- V7623 - Distance Between Shelves 860mm (Top) 875mm (Bottom)



V7620



V7621



V7622



V7623

Code	Details	Door Opening Size (mm)	Internal Size LxWxH (mm)	External Size LxWxH (mm)	Unit Weight (kg)
V7620	Fork Gas Storage Cage (2 Cylinders)	650x780	690x380x815	730x430x960	32
V7621	Fork Gas Storage Cage (4 Cylinders)	650x810	690x680x845	730x730x990	43
V7622	Fork Gas Storage Cage (6 Cylinders)	1000x810	1040x680x820	1080x730x990	60
V7623	Fork Gas Storage Cage (12 Cylinders)	1000x1760	1040x680x1760	1080x730x1940	108

## Aerosol Lockable Storage Cages

- Heavy duty steel construction storage cages designed specifically for aerosol cans, however are a great storage cage for tools and equipment
- Power coated green
- All cages have lockable doors and bolt down plates for added security
- Designed to comply with relevant Australian Standards



Code	Details	Internal Size LxWxH (mm)	External Size LxWxH (mm)	Door Opening Size (mm)	Unit Weight (kg)
V7660	Aerosol Storage Cage (12 Can Capacity)	490x205x355	500x250x400	440x320	12
V7661	Aerosol Storage Cage (60 Can Capacity)	695x265x605	700x300x650	640x570	25
V7662	Aerosol Storage Cage (108 Can Capacity)	845x360x850	852x400x900	770x820	34
V7663	Aerosol Storage Cage (216 Can Capacity)	1650x365x850	1655x400x900	1575x820	85





# Aerosol Lockable Storage Cages

- Heavy duty steel construction storage cages designed specifically for aerosol cans, however are a great storage cage for tools and equipment
- Power coated green
- All cages have lockable doors and bolt down plates for added security
- Designed to comply with relevant Australian Standards



Code	Details	Internal Size LxWxH (mm)	External Size LxWxH (mm)	Door Opening Size (mm)	Unit Weight (kg)
V7664	Aerosol Storage Cage (216 Can Capacity)	847x368x1750	850x400x1800	770x1720	77
V7665	Aerosol Storage Cage (432 Can Capacity)	1650x365x1750	1655x400x1800	1575x1720	152





## Fixed Safety Bollards

- Ideal for protecting expensive equipment and racking from possible forklift damage
- Great for protecting edges of roller doors from truck damage
- 3 options available however other sizes can be made to order to your particular specifications
- Powder coated finish

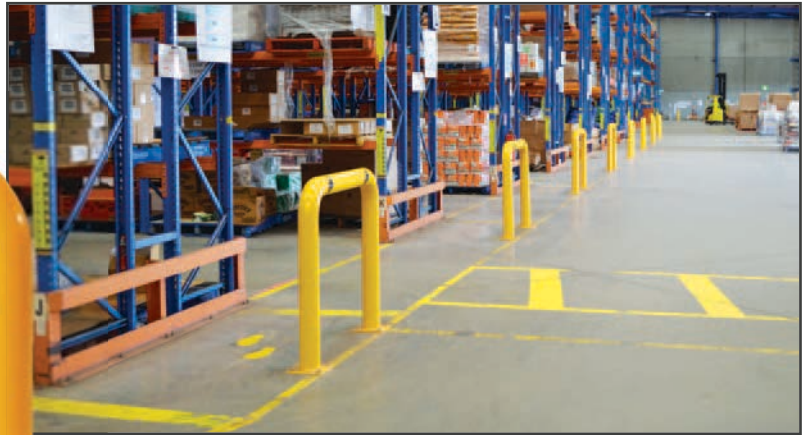

V7420



V7427  
Tru-Bolt to suit



V7421



V7422

Code	Details	Size (mm)	Diameter (mm)	Bolt Hole Size (mm)	Base Plate Size (mm)	Unit Weight (kg)
V7420	'U' Bar High Bollard	1068x1220 (HxL)	115	22	203x203x10	29.5
V7421	'U' Bar Low Bollard	230x1220 (HxL)	115	22	203x203x10	16
V7422	Fixed Straight Bollard	915 (H)	115	22	203x203x10	10.5
V7427	Tru-Bolt Galvanised 16x120mm (M16)					



# Safety Bollards (Concrete Fillable)

- Ideal for protecting expensive equipment and racking from possible forklift damage
- Great for protecting edges of roller doors from truck damage
- 2 options available however other sizes can be made to order to your particular specifications
- The 1200mm high bollards (V7425 & V7426) can be concrete filled
- Available in Galvanised and Powder coated options
- Wall thickness: 3mm



Removable cap which allows bollards to be concrete filled if required



V7426



V7425



V7427  
Tru-Bolt to suit

Code	Details	Height (mm)	Diameter (mm)	Bolt Hole Size (mm)	Base Plate Size (mm)	Unit Weight (kg)
V7425	Galvanised Bollard	1200	165	17	280x280x10	22
V7426	Powdercoated Yellow Bollard	1200	165	17	280x280x10	22
V7427	Tru-Bolt Galvanised 16x120mm (M16)					





## Safety Guard Rail Fencing

- Protect expensive equipment from forklift damage using bolt together post and panel modular system
- Heavy duty powder coat yellow steel construction
- Easily assembled and disassembled rail system
- Supplied with all necessary bolts and fixings
- Base Size of the post is 255x255x16mm







Double Rail



Single Rail

Corner Post Comes with bolt holes on two adjoining sides

Centre Post Comes with bold holes on two opposite sides

Base Size of the post is 255x255x16mm



V7435 -1120mm long



V7436 -1730mm long



V7437 -2340mm long

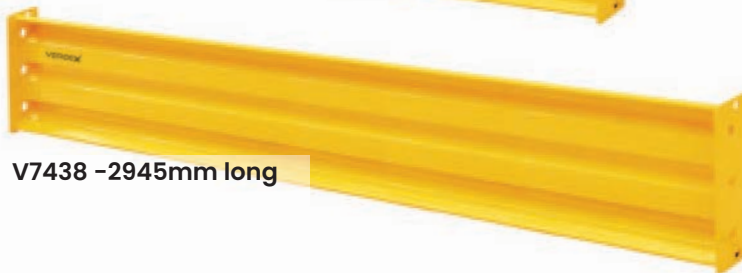

V7438 -2945mm long



V7430

V7432



V7431



V7433

Code	Description	Dimensions (mm)	Height (mm)
V7430	Single Height Corner/End Post	100x100	470
V7431	Single Height Centre Post	100x100	470
V7432	Double Height Corner/End Post	100x100	1085
V7433	Double Height Centre Post	100x100	1085

Code	Description	Height (mm)	Length (mm)
V7435	Safety Rail Section	370	1120
V7436	Safety Rail Section	370	1730
V7437	Safety Rail Section	370	2340
V7438	Safety Rail Section	370	2945



# Pedestrian Handrail Barrier System

Our modular pedestrian barrier system is very easy to install with 2 metre long rails to form a continuous barrier or can be cut to your desired length. The 950mm high posts simply lock together with pre-fitted couplings.

Our system uses rounded corners which allow you to have a continuous handrail along winding passage-ways and around corners.

- No welding required, easily assembled and versatile
- Made to Australian Standards AS 1428.1:2021 and AS 1657:2018
- Powder coated yellow Post and Rail
- Hot Dipped Galvanised Cast Iron Connectors and Base Flange
- Post Rails: 48 (D) x 950mm
- Horizontal Rails: 48 (D) x 2000mm
- All Post are supplied with 2 x M10 60mm Galvanised Dynabolts

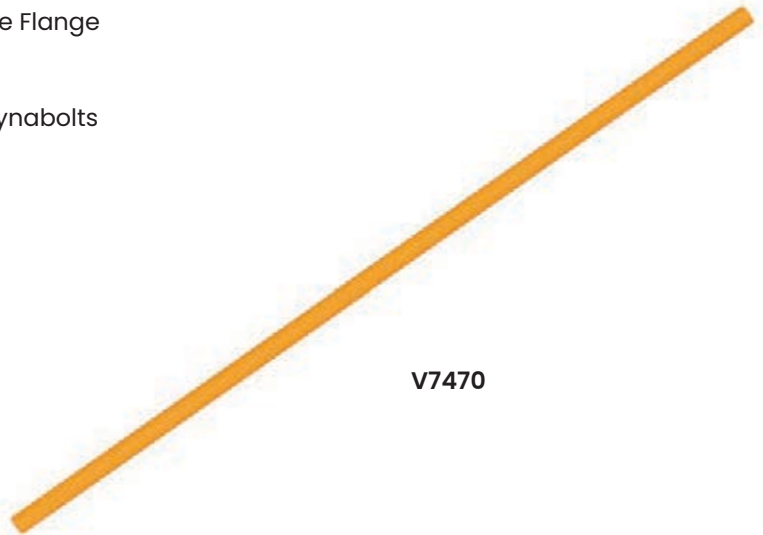

V7470



V7471 - End Post

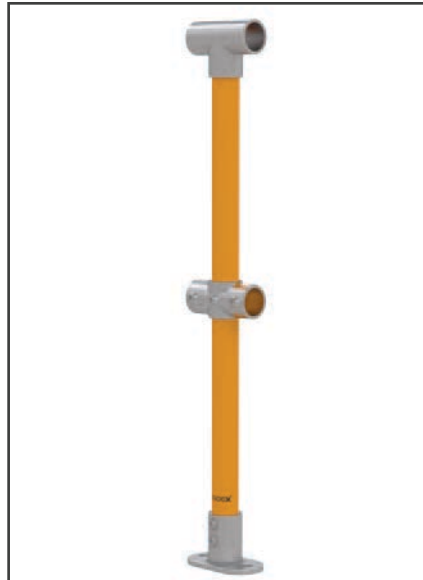

V7472 - Centre Post

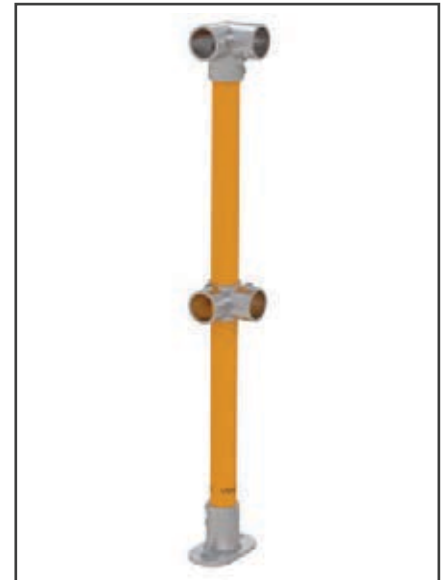

V7473 - Corner Post

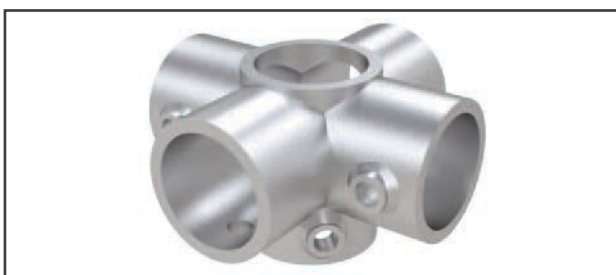

V7474 - 4 Way Center Cross Coupling Set



V7475 - Side Outlet Tee Set

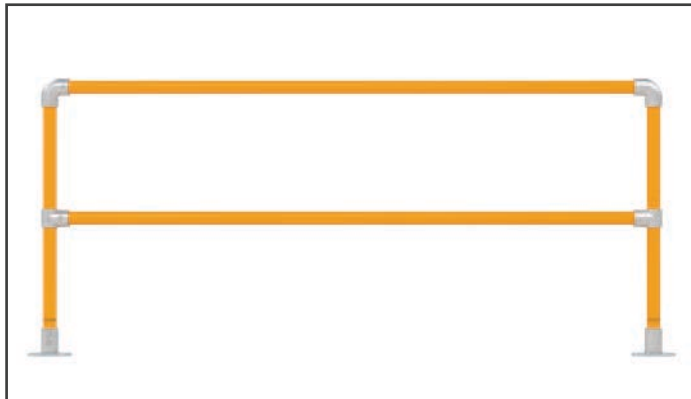

V7470 Pedestrian Rail with V7471 End Posts

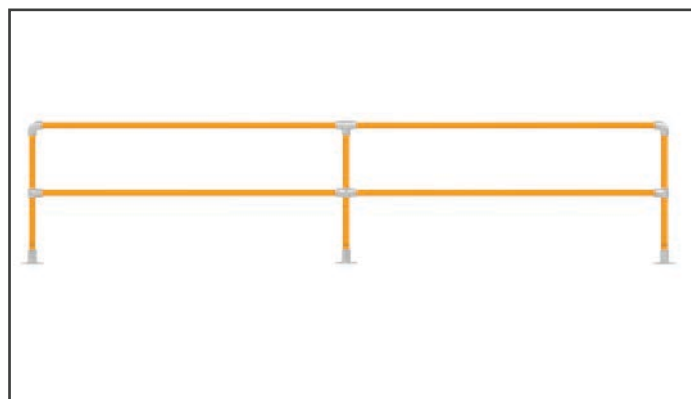

V7470 Pedestrian Rail with V7471 End Posts & V7472 Centre Posts

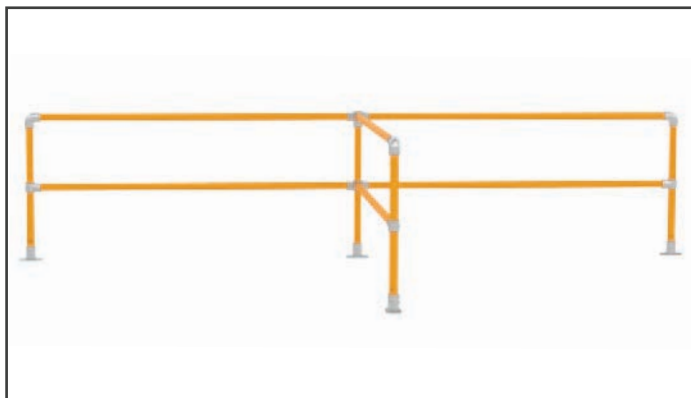

V7470 Pedestrian Rail with V7471 End Posts

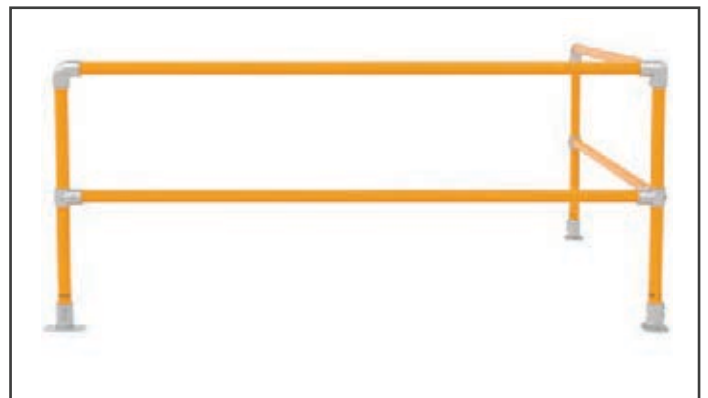
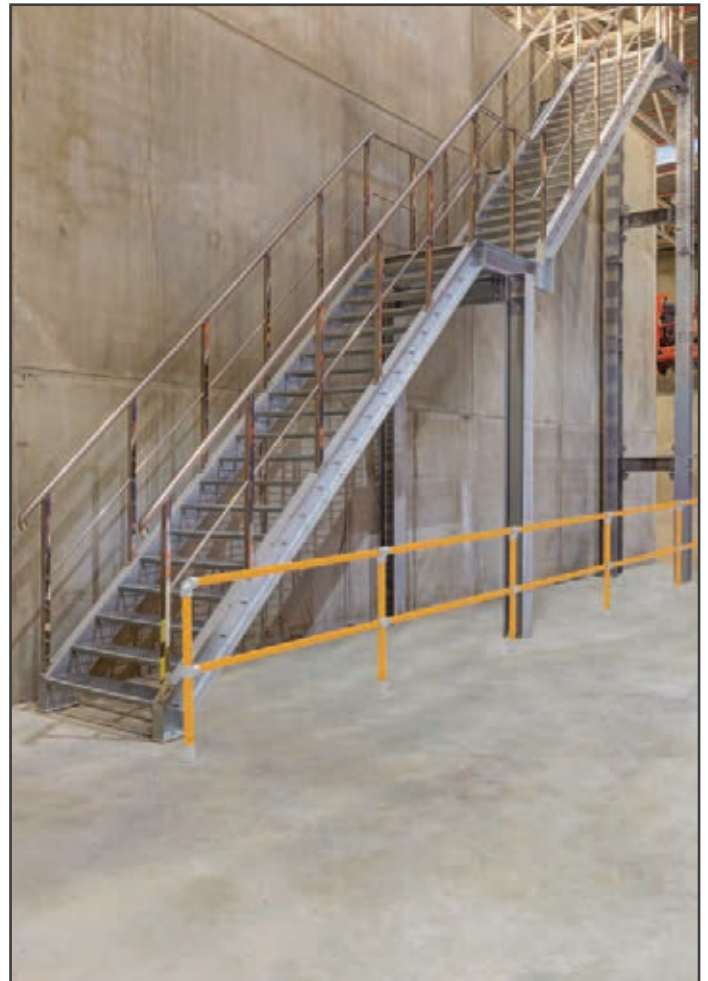

V7470 Pedestrian Rail with V7471 End Posts & V7473 Corner Posts

Code	Description	Unit Weight (kg)
V7470	2M Pedestrian Handrail (sold as a pair)	14
V7471	Pedestrian Handrail (End Post)	5.5
V7472	Pedestrian Handrail (Centre Post)	6
V7473	Pedestrian Handrail (Corner Post)	6
V7474	4 way Center Cross Coupling Set (sold as a pair of 2)	2.7
V7475	Side Outlet Tee Set (sold as a pair of 2)	2





## Single Belt Retractable Post Barrier with 2m Belt

- Used as a portable crowd control and for other settings to manage and guide the flow of people.
- Consists of a retractable belt within a post, allowing for easy set up and removal.
- Black coloured Belt
- Cast Iron Black Base with Steel Cover
- Built in Rubber Floor Protectors
- Black Powder Coated Finish
- Diameter of Base: 350x25mm



V7414



V7413

Code	Length (mm)	Width of Belt (mm)	Height (mm)	Unit Weight (kg)
V7413	2000	50	1000	9.3
V7414	2000	50	1000	9.5

## Wall Mount Retractable Barrier with 10m Belt

- Setting up the display is straightforward with the included hardware kit.
- Black & yellow diagonal stripes for hazard alert
- This unit offers flexibility as it includes all combinations of fixings and mounts - Retractable belt is 10m long, making it easy to section off any area
- The unit can be mounted to the wall by Magnetic, Adhesion or screws
- Available in 5m and 10m lengths



*\*Please Note - V7416 is too wide to fit on the front face of most standard pallet racking*

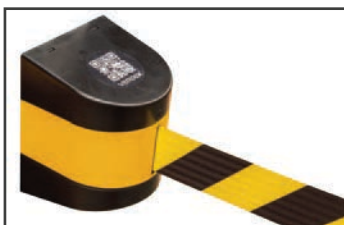

Code	Details	Length (mm)	Unit Weight (kg)
V7416	Wall Mount Retractable Barrier with 5m Belt	10,000	1
V7417	Wall Mount Retractable Barrier with 10m Belt	5000	0.6



## Safety Swing Gate

- Self closing gate is designed to restrict access to areas of potential hazard
- Authorised Personnel Only sign supplied (x2)
- Adjustable to suit 830-1280mm openings
- Suits ball fence & SHS up to 50mm
- Gate swings inward
- Fits left and right hand openings, inwards opening
- Can be used with ball fence gates
- Built-in gate stop
- Self-closing stainless steel spring hinges
- Zinc Finish
- V7454 Base Plate Size: 150x150mm



V7455



V7455 pictured with 2 x V7454 (Posts to suit)

Code	Details	Overall Length (mm)	Height (mm)	Width (mm)	Unit Weight (kg)
V7455	Safety Swing Gate	910-1360	440	110	10
V7454	Post to suit V7455	-	1000	-	5

## Adjustable Safety Swing Gate

- Self closing gate is designed to restrict access to areas of potential hazard
- Adjustable to suit 780-1330mm openings
- Suits ball fence & Pedestrian Handrail System
- Gate swings inward
- Fits left and right hand openings, inwards opening
- Built-in gate stop
- Heavy Duty Self-closing hinges
- Powder Coat Finish
- V7477 is supplied with 2 x Vinyl Stickers (400x300mm)



V7476



V7477

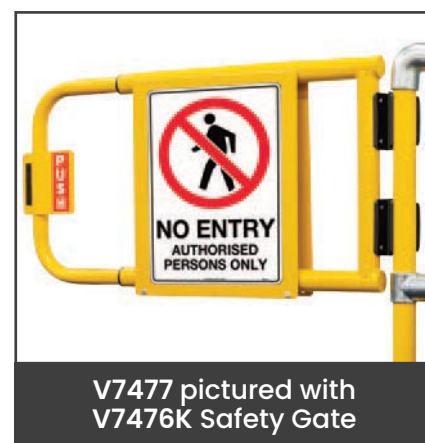

V7477 pictured with V7476K Safety Gate

Code	Details	Overall Length (mm)	Overall Size (mm)	Unit Weight (kg)
V7476K	Adjustable Safety Gate	890 - 1440	440x50 (WxD)	11
V7477	Adjustable Safety Gate Sign Holder	-	512x425x53 (HxWxD)	4



### 3 Metre Expanding Barrier

- Made from powder coated steel, aluminium and high-tech plastics
- Colour: Black/Yellow
- Compact design
- Rubber castors – 4 x swivel with brakes

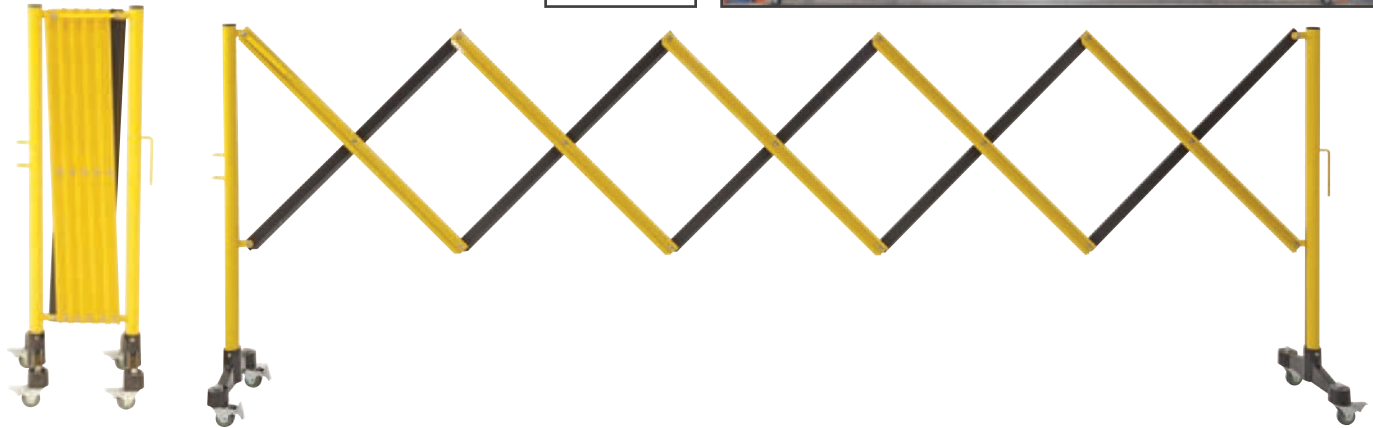

Code	Castors (mm)	Base Width (mm)	Collapsed Size LxH (mm)	Expanded Size LxH (mm)	Height with castors (mm)	Height without castors (mm)	Unit Weight (kg)
V7412	50	305	350x1030	3000x1030	1030	970	6

### 5 Metre Double Expanding Barrier

- Made from powder coated steel, aluminium and high-tech plastics
- Colour: Black/Yellow
- Rubber castors – 6 x swivel with brakes

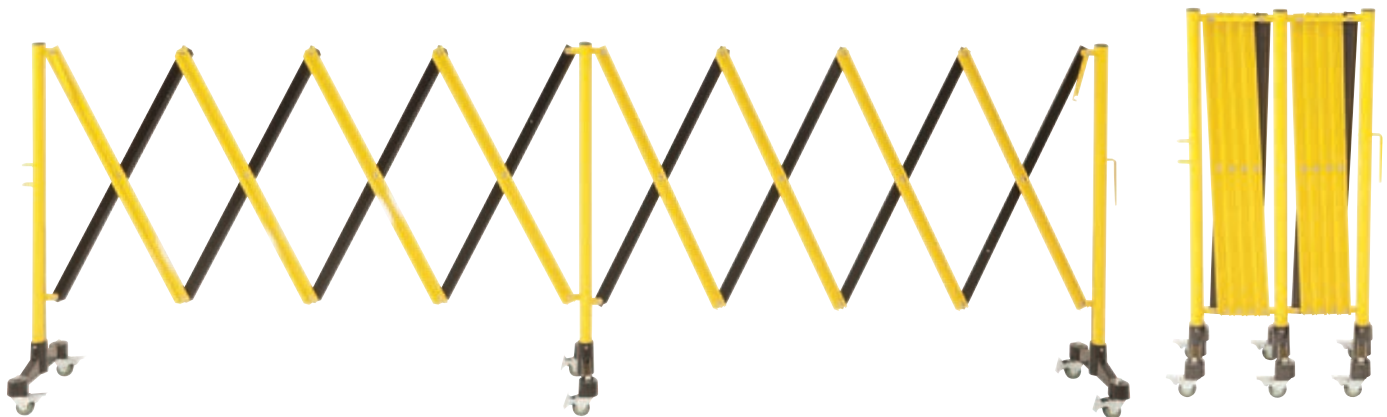
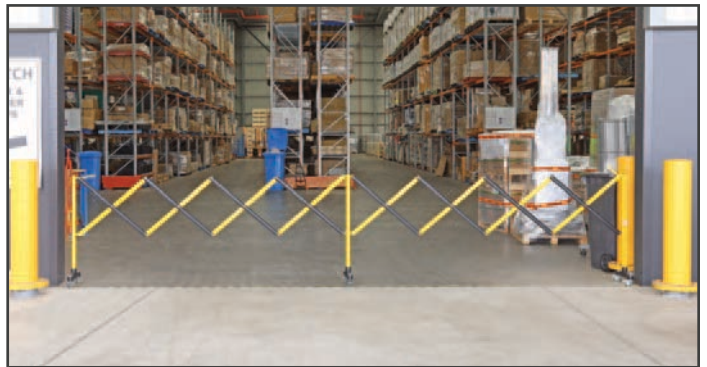

Code	Castors (mm)	Base Width (mm)	Collapsed Size LxH (mm)	Expanded Size LxH (mm)	Height with castors (mm)	Height without castors (mm)	Unit Weight (kg)
V7410	50	305	540x1030	5000x1030	1030	970	11





## 7.1 Metre Expanding Barrier

- Made from powder coated steel and aluminium
- Colour: Black
- Rubber castors - 8 x swivel with brakes

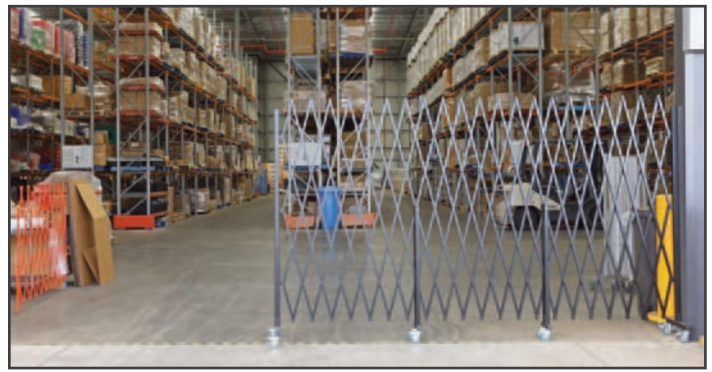
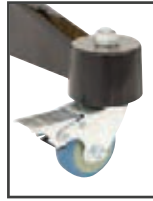

Code	Castors (mm)	Base Width (mm)	Collapsed Size LxH (mm)	Expanded Size LxH (mm)	Barrier Tube Size (mm)	Post Size (mm)	Unit Weight (kg)
V7415	75	460	560x2050	7100x1930	20x20	40x40	36

## Light Weight Expanding Barrier

- Portable, lightweight and durable
- Built-in handle and locking strap for ease of handling
- Corrosion resistant
- Use indoors or outdoors
- Safety yellow and black plastic construction
- Injection moulded ABS plastic
- Width: 2.4 metres expanded (250mm closed)



Code	Height (mm)	Width expanded (mm)	Width closed (mm)	Unit Weight (kg)
V7409	970	2400	250	3



# Heavy Duty Floor Angles

- Verdex's Floor Angles are durable and essential for high-traffic areas.
- Designed to prevent pallets or other items from obstructing walkways and creating damage to assets or structures
- Heavy duty steel construction
- Hole Diameter: 18mm
- Please note; 9 V7483 Screw Bolts are required for V7486, 3 for V7487 and 3 for the V7488 (purchased seperately)

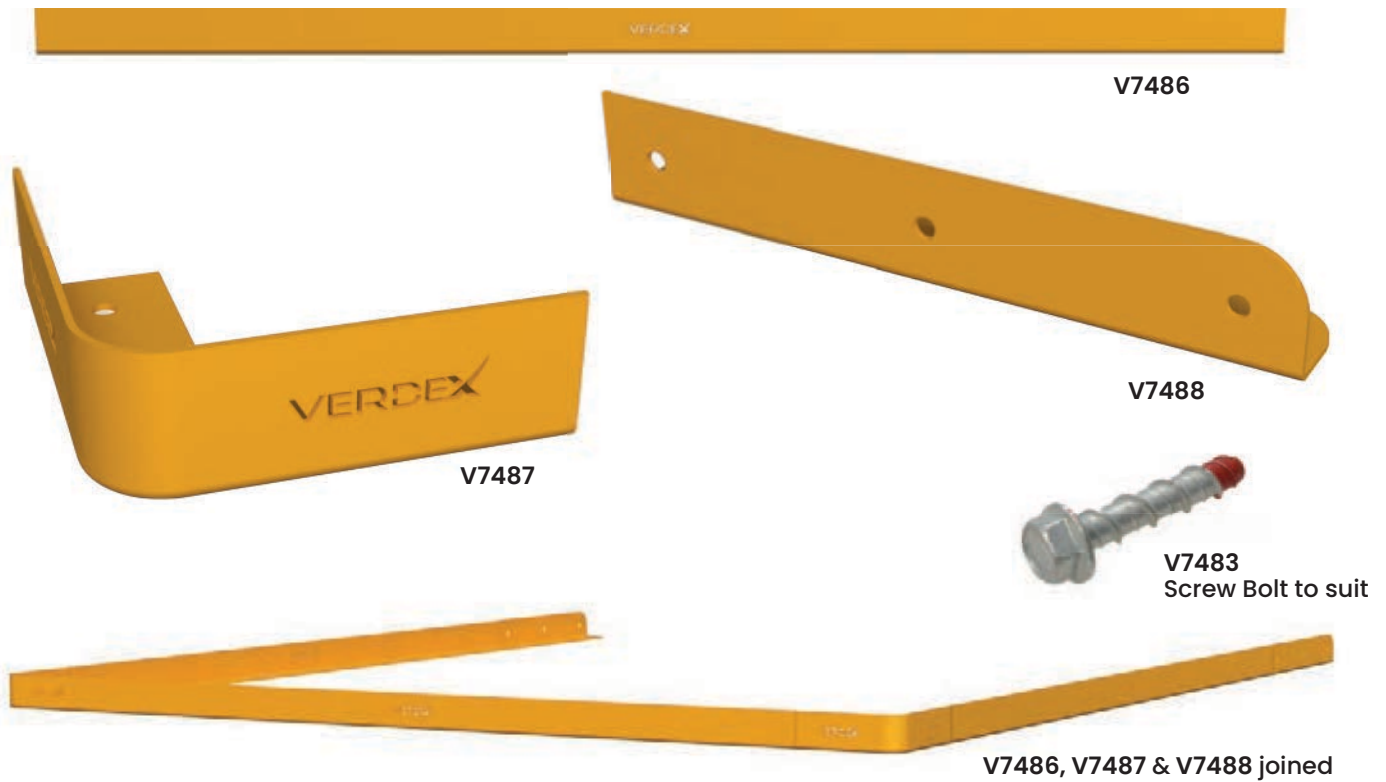

Code	Details	Overall Size (mm)	Unit Weight (kg)
V7486	Heavy Duty Floor Angle - 2.4M	2400x100x100	17.8
V7487	Heavy Duty Floor Angle (Corner)	300x300x100	3.8
V7488	Heavy Duty Floor Angle (End)	600x100x100	4.3
V7483	Galvanised Screw Bolt to suit (M12x75mm)		





# Forklift Wheel Stop

- Verdex's Forklift Wheel Stops are durable and designed to enhance safety and efficiency.
- They ensure proper parking alignment, prevent damage to structures, assist with docking, and help to organize spaces effectively.
- Designed to protect assets and machinery in warehouses
- Please note; 5 V7483 Screw Bolts are required for the V7484 Wheel Stop (purchased seperately)

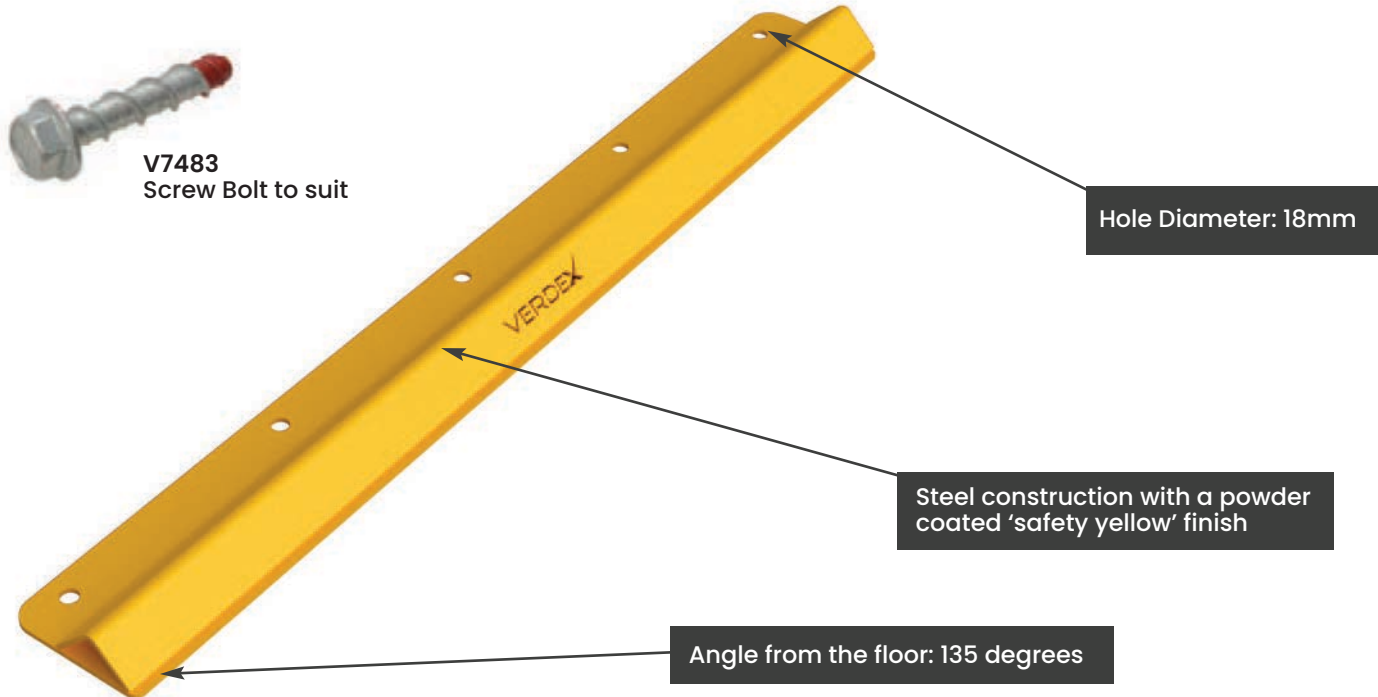

Code	Details	Size LxWxH (mm)	Hole Diameter (mm)	Unit Weight (kg)
V7484	Forklift Wheel Stop	1200x150x50	18	19
V7483	Galvanised Screw Bolt to suit (M12x75mm)			







# EXPLORE OUR PPE RANGE



## WE'VE GOT YOUR EARS COVERED

Hearing protection including  
Ear plugs, Dispensers & Muffs



ALL EYEWEAR  
PROTECTION  
IS CERTIFIED TO  
AS/NZS  
1337.1:2010

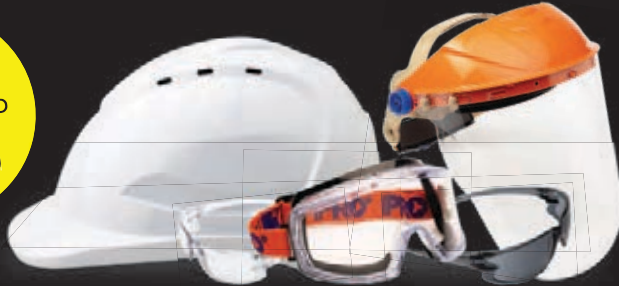

## HEADS UP!

Assorted Hard hats,  
Safety goggles, Safety  
glasses & face protection



## GLOVES FOR ALL APPLICATIONS

A range of gloves including  
Ventilated, PVC, Polycotton,  
Liner, Nitrile & Nylon



GLOVE  
CLIP KEEPERS  
ALSO AVAILABLE

## SAFETY FIRST

Various Safety Chains,  
Barricade Tape, Traffic Cones,  
Safety Tags & Bunting



## GEARED UP

Gear up with our new range of Protective  
Wear including Rain Coats with Pants,  
Hi-Vis Vests & Respirators



SCAN TO VIEW OUR  
FULL RANGE ONLINE:





# Barricade Tape

- Barricade Tape is used to alert passersbys of an area or situation containing a possible hazard
- 100 metre roll x 75 mm width
- Heavy Duty Plastic
- Qty/Pack - 5

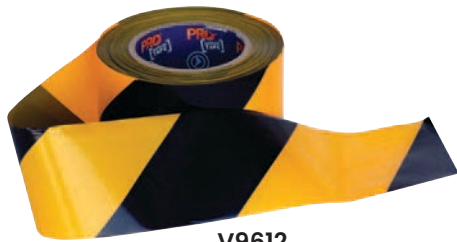

V9612



V9611



Code	Details
V9611	Barricade Tape - Red/White
V9612	Barricade Tape - Black/Yellow

# Bunting

- Hi-Vis is fluoro PVC triangle flags
- 30 metre length
- Reusable high strength nylon rope
- 45 flags
- Sold Individually
- Provides excellent visibility for hazardous areas



Code	Details
V9613	Hi -Vis Bunting



## T-Top Bollards

- Fluoro red post with reflective tape
- Heavy weight Rubber base
- Complies to relevant Australian Standards



Code	Details	Overall Height (mm)	Rubber Base Weight (kg)
V7450	T-Top Plastic Bollard (Base & Top)	1150	6
V7451	T-Top Bollards Top Only		

## Traffic Cone - Extension bar

- Made from exterior grade ABS plastic and UV stabilised to withstand temperature extremes and sunlight
- Extendable bar starts at 135cm, extending to 210cm long as required
- Includes simple twist lock system at required length
- Features 4 yellow reflective bands for added visibility
- Sold Individually
- Includes soft durable rubber loops on both ends for easy attachment to traffic cones and bollards

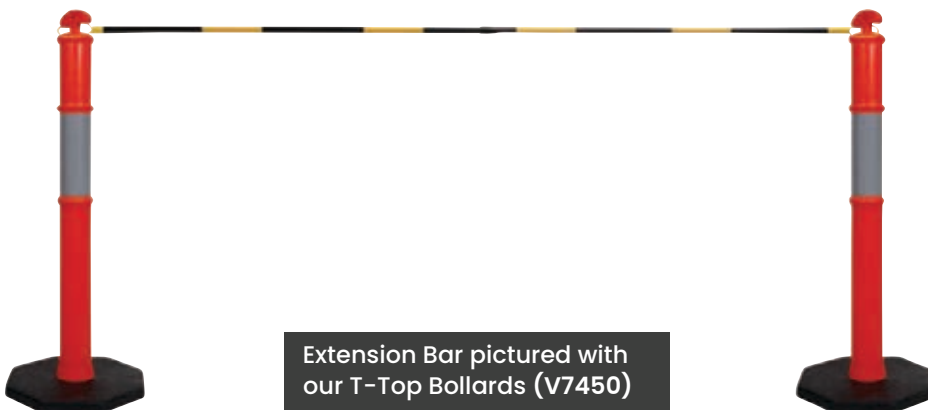

Code	Details
V9614	Traffic Cone Extension Bar





## Traffic Cones

- Lightweight yet durable Traffic Cones, that can used in a variety of settings road works, construction sites and parking lots.
- High quality orange PVC
- Sold Individually



V9616



V9615

Code	Details
V9615	Traffic Cone - 450mm high
V9616	Traffic Cone - 700mm high

## Traffic Cones – with Reflective Tape

- Lightweight yet durable Traffic Cones, that can used in a variety of settings road works, construction sites and parking lots.
- High quality orange PVC  
150mm reflective tape complies to AS/NZS 1906.1:2007 standards
- High intensity reflective tape
- Providing even greater visibility
- Sold individually



V9617



V9618

Code	Details
V9617	Traffic Cone with Reflective Tape - 450mm high
V9618	Traffic Cone with Reflective Tape - 700mm high



## Footprint Floor Marking Stickers

Footprint floor marking is commonly used in numerous industrial and commercial applications to improve safety, organization, and efficiency.

They help in segregating pedestrian walkways from vehicle paths, thus reducing the risk of accidents. This is mostly important in areas where forklifts or other machinery are being used.

- Sold as 5 pairs
- Material : Vinyl
- Indoor Outdoor use



Code	Overall Size LxW (mm)
V9540	254x89

## Industrial 'STOP' Floor Marking Stickers

Industrial 'STOP' floor marking is used to improve safety and organization in industrial environments including factories, warehouses, and manufacturing facilities.

These markings are especially significant in areas with high foot or vehicle traffic, intersections, or areas of potential hazard.

- Sold as a pair
- Material : Vinyl
- Indoor and Outdoor use

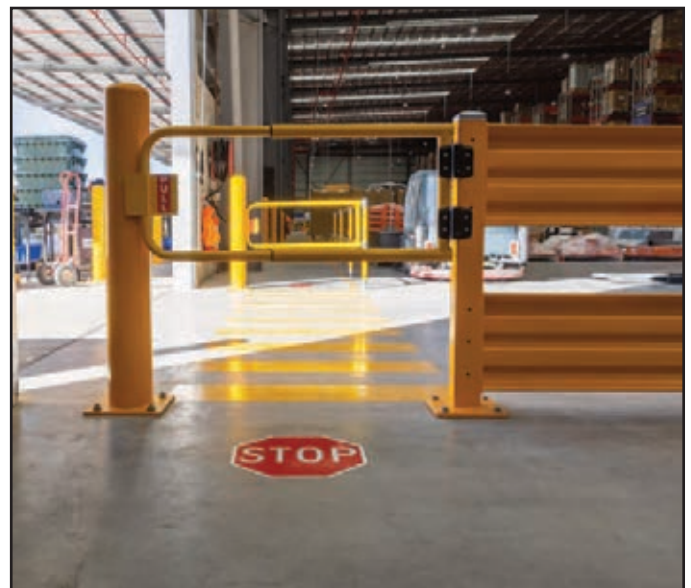

Code	Overall Size (mm)
V9541	400x400

# WE'VE GOT YOUR SIGNAGE NEEDS COVERED ...



Various Keep Clear, No Entry & No Admittance signs perfect for a range of applications



FOR WHEN YOU  
MUST  
PROTECT



Protective Equipment  
signage to promote  
workplace safety



Range of instructional signs suitable for areas which specific rules & restrictions apply

Signage to guide pedestrians  
& warn of any potential hazards.  
Suitable for a range of environments



FOR WHEN YOU  
NEED TO  
GUIDE



VIEW OUR FULL RANGE ONLINE:

[verdex.com.au/safety-barriers-ppe-signage/signage/](https://verdex.com.au/safety-barriers-ppe-signage/signage/)



## Safety Tags

- Safety Tags are used to prevent accidental injury or illness to employees who are exposed to hazardous conditions that may be unexpected.
- 125mm x 75mm
- Non tear/all weather
- Qty/Pack - 100 Tags



V9619

V9620

Code	Details
V9619	Safety tags - Danger
V9620	Safety tags - Out of Service

## Safety Chains

- A high strength plastic safety and barrier chain which can be used to cordon off work place and public access areas
- Provides excellent visibility for hazardous areas
- UV stabilised
- Available in Safety yellow colour and Red & White
- 8mm thick plastic loops
- Sold per 25 metre roll

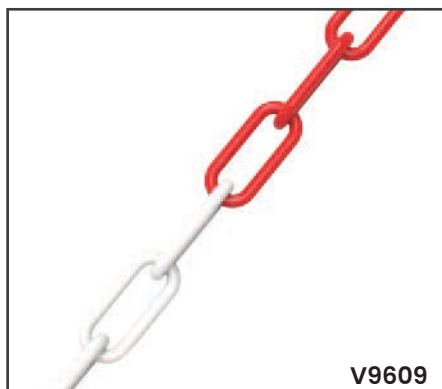

V9609

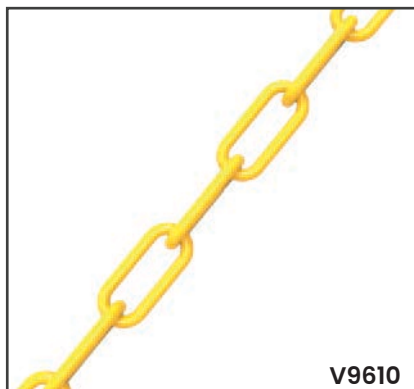

V9610



Code	Details
V9609	Safety Chain - Red/White
V9610	Safety Chain - Yellow



# Heavy Duty Wheel Chock Trolley

- These units are a great addition for loading docks, depots or parking areas.
- Finish: Powder coat Yellow
- V1213 Capacity: 6 Heavy Duty Rubber Wheel Chocks (V7847)
- V1214 Capacity: 2 Heavy Duty Rubber Wheel Chocks (V7847)
- Fitted with 2 Wheel Chock Holder (V7847)
- Optional add-on Holder is available (V1214)
- 200mm Rubber Wheels

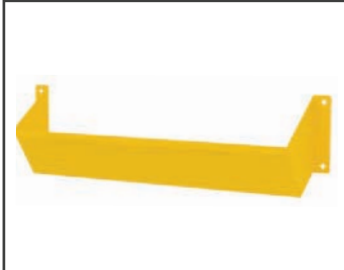

V1214 Wheel Chock Holder



V1213 Wheel Chock Trolley

Code	Details	Overall Size LxWxH (mm)	Unit Weight (kg)
V1213	Wheel Chock Trolley	815x475x1130	16
V1214	Wall Mounted Wheel Chock Holder	570x110x115	1

# Heavy Duty Rubber Wheel Chock

- The Heavy Duty Rubber Wheel Chocks are designed to prevent unintentional movement of vehicles, especially when they are parked or stationary.
- These Wheel Chocks can be used for various applications such as maintenance, loading/unloading, truck/trailer parking, boat trailers, construction sites.
- Manufactured from 100% recycled rubber
- Superior construction ensures the wheel chocks will not warp, crack, chip or rot
- Rope Material: Yellow Darcon
- Rope Length: 1000mm
- These Wheel Chocks are sold as 2/carton



Code	Size LxWxH (mm)	Unit Weight (kg)
V7847	285x250x185	6.5



## R2 Response Plus First Aid Kits

- Complies with WHS 2019 Regulations for Workplaces, high risk 1-25 persons.
- Ideal general purpose First Aid Kit for any application.
- Includes Eye 'n' Wound, Burn and Outdoor modules for catering to specific injury risks in these areas.
- Available in 3 case options to suit almost any application in the workplace.
- Dimensions (WxHxD): 285x420x130mm

Scan here to view the First Aid Pack contents online



V9532



V9531



V9533

Code	Details
V9531	Response Plus First Aid Kit, Metal Wall Mount
V9532	Response Plus First Aid Kit, Soft Pack
V9533	Response Plus Kit Refill Pack





# R4 Medic First Aid Kits

- Complies with WHS 2019 Regulations for Workplaces, high risk 1-50 persons.
- One of the biggest and best in our R4 range, especially suited to first aid rooms, etc.
- Additional modules to make contents easily locatable.
- Available in 2 case options to suit almost any application in the workplace
- Hospital-grade content to provide an effective response to injuries.
- Dimensions (WxHxD): 410x575x130mm

Scan here to view the First Aid Pack contents online



V9535



V9534



V9536

Code	Details
V9534	Constructa Medic Kit, Metal Wall Mount
V9535	Constructa Medic Kit, Soft Pack
V9536	Constructa Medic Refill Kit



## Custom Projects

Our in house design & engineering team can assist in creating products to suit your workplace necessities. We will work with you every step of the way to take your specific requirements from vision to execution.

*We've assisted many Australian businesses in enhancing workplace safety & efficiency by providing the highest quality range of products.*

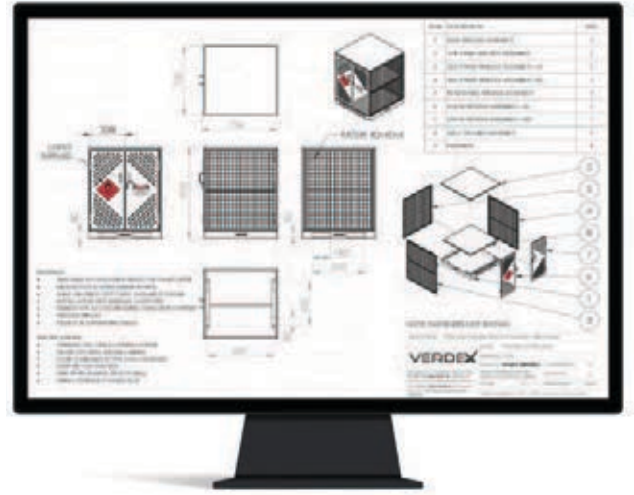

*Our custom projects portfolio features a diverse product range including:*

**TROLLEYS • LIFTERS • STILLAGES  
WORKBENCHES • CONVEYORS • RAMPS  
ATTACHMENTS • SHELVING / STORAGE**

***For over 30 years Verdex has fulfilled project workplace orders by creating products specifically curated to suit our customer's needs.***

*We understand that a one-size-fits-all approach is not suitable for every workplace. Which is why Verdex welcomes all enquiries & is dedicated to equip your business with products to suit your exact application.*





## Fully Realised Workplace Solutions

From concept to construction, our team will design & construct products to suit your specific application. Our mission is to equip workplaces with the safest & highest quality products, which is why every product is tested & certified to meet Australian Standards.

*All product testing is carried out locally to ensure premium quality. We provide certification for all designs available at any request.*



**GET IN TOUCH WITH THE TEAM TODAY  
FOR ALL YOUR CUSTOM SOLUTIONS**

**1800 750 500**  
sales@verdex.com.au



**EXPERIENCE  
THE VERDEX  
DIFFERENCE**

*All Verdex products are extensively tested & comply to relevant Australian Standards. You can trust when you make a purchase with us, you are investing in quality beyond compare*





## SOLUTION BASED PROCESSES

Our in-house engineers have dedicated countless hours on the design & development of custom projects to equip businesses with safe & efficient products.



*We've designed hundreds of trolleys to suit just about any application across a wide range of industries*



*Our team has assisted in creating customised lifting solutions for businesses across Australia*





# ENHANCED WORKPLACE STORAGE

Our team can assist in maximising your workspace with customised storage solutions. We will work to create a safer & more efficient workplace suited specifically to your requirements.



From Stillages to Shelving of all shapes & sizes,  
*we can create enhanced storage solutions to suit your business*





Our team can also modify or alter products we currently stock.  
To view our full product range visit [www.verdex.com.au](http://www.verdex.com.au)



See something  
you like?

**GET IN TOUCH WITH THE TEAM TODAY  
& EXPERIENCE THE VERDEX DIFFERENCE**

1800 750 500 | [sales@verdex.com.au](mailto:sales@verdex.com.au)













**A**

ABS Plastic Louvre Panel	129
A Frame Rigging Racks	170
A Frame Panel Cart	51
Access Bin Racks	132, 133
Adjustable Gate	291
Adjustable Shelf Trolley	65
Aerosol Storage Cage	282, 283
All Terrain Pallet Truck	208
All Terrain Trolley	48
Aluminium Hand Stacker	199
Aluminium Hand Truck	200
Aluminium Lifters	199, 200
Aluminium Platform Trolley	200
Aluminium Scissor Lift Trolley	178
Aluminium Trolleys	16, 42, 43, 178
Anti-Fatigue Mats	103
Appliance Hand Trolleys	42-46
Assembly Line Conveyor	232-235
Automatic Pallet Hook	215
Automatic Pallet Positioner	187

**B**

Barricade Tape	297
Barriers - Crowd Control	288-290, 292, 293
Barriers - Expanding	292, 293
Barriers - Fixed	286-289
Basket Trolleys	11, 16, 17, 22, 23, 27, 37, 45, 57, 64, 65, 87
Battery Electric Lifters	192-194
Battery Electric Wheelie Bin Tipper	252, 253
Beam - Forklift Spreader	214
Beer Keg Trolley	44
Belt Barrier	290
Bench Scales	120
Benches - Work	104-113
Bin Compactor	259
Bin Lifter	255
Bin Racks	132, 133
Bin Stands	246
Bin Tipper	225, 250-254
Bin Tipper - Forklift Attachment	225, 250, 251
Bin Trolleys	54, 55, 93, 242, 243
Bins - Foot Pedal Operated	247
Bins - Forkliftable	250, 251, 255-261, 263-265
Bins - Small Parts Storage	122-127
Bins - Storage	115
Bins - Waste	55, 242, 244, 245, 247-249, 255-265
Bins - Wheelie	246-249
Bishamon Lift Tables	187
Bollards	284, 285, 298
Bollards - T-Top	298
Boot Cleaning Brush & Grate	171
Brooms	238, 240, 241
Brute Bins	244, 245
Bucket - Plastic	134
Bulk Bag Filing Frame	169
Bulk Bag Lifter	213
Bulk Dangerous Goods Store	277
Bulk Handling Bins	136, 137
Bunded Pallet	267
Bunding Products	47, 267-269, 273
Bunting	297

**C**

Cabinet - Storage	96-101, 105-107, 114, 117
Cabinet Stand	98, 99
Cable Drum Slippers	211
Cable Drum Stirrups	211
Cage Trolley	66-89
Cages - Mesh	138-143, 146-149
Cages - Pallet	142
Carpark Equipment	295-297, 303
Carpet Roll Prong Fork Attachment	210

Cart Utility	38-41
Chair Trolley	63
Chemical Storage Cabinets	275-277, 282, 283
Chock/Wheel	303
Cleaners Trolley	36, 54, 55, 57, 242, 243
Cleaning Equipment	236-243
Cleaning Shadow Board	238
Clear View Storage Bins	125
Collapsible Storage Cage	138-141, 144-147
Collapsible Trolley	16
Column Guards for Pallet Racking	157
Compactor - Waste Bin	259
Compartment Boxes	127
Computer Cart	61
Concrete Block Moulds	167
Concrete Collection Tray	166
Concrete Fillable Bollard	285
Concrete Kibble	168
Concrete Washout Bins	256
Construction Trolley	46-53
Container Ramps	162-165
Containment Bunds	47, 267, 273
Convertible Trolley	43, 77
Conveyors	232-235
Conveyor Components	234
Corrosive Goods Cabinets	275
Court Trolley	45
Crane Cage	148
Crane Hook	214, 215
Crane Spreader Beam	214
Crane Storage Bin	262
Crate Dollies	130
Crates - Plastic	130-134, 136, 137
Crowd Control Barriers	288-290, 292, 293
Cupboards	96, 98-101, 105-107, 114
Custom Equipment	306-311
Cylinder Cages	273, 278, 280
Cylinder Trolley	45, 46, 272

**D**

Dangerous Goods Cabinet	276, 277
Decanting Trolley/Stand	191
Dollies - Crate	130
Dollies - Drum	222
Double Scissor Lift Trolleys	175, 179, 181
Double Tub Trolley	24, 58, 59
Double Width Storage Cage	140, 147
Drawer Cabinet	92, 96-101, 105-107
Drawer Trolley	38, 60, 61
Drop Bottom Bins	263-265
Drum Bunding Pallets	267
Drum Carrier / Rotator	219
Drum Cradle	218
Drum Dispensing	47, 219, 224, 225, 230, 231, 273
Drum Dollies	222
Drum Dumper	225
Drum Grab	225
Drum Handling Fork Attachment	211, 224-227
Drum Lifter	221, 223, 226, 230, 231
Drum Lifter With Scales	221
Drum Palletiser	228
Drum Positioner	227
Drum Prong	218, 221, 227
Drum Rotator	224, 227
Drum Sling Lifter	223
Drum Spill Containment	268, 269, 273
Drum Stacker	268, 269
Drum Storage	47, 267-269, 273
Drum Tipper	225
Drum Tongs	223
Drum Trolley	47, 218, 220, 273
Dump Truck - Powered	15
Dustpan	240, 241





- E**
- Electric Conveyor ..... 233
  - Electric Drum Lifter / Rotator ..... 231
  - Electric Fork Stackers ..... 198
  - Electric Lift Trolleys ..... 176, 180, 181, 192-194
  - Electric Pallet Truck ..... 203, 209
  - Electric Scissor Lift Table ..... 184, 185, 189
  - Electric Scissor Lift Trolley ..... 176, 180, 181
  - Electric Work Positioner ..... 192-194
  - End Protectors for Pallet Racking ..... 156
  - Enviro Crates ..... 130
  - Equipment Skates ..... 90, 91
  - Ergo Tred Matting ..... 103
  - Event Control Barriers ..... 288-290, 292-295
  - Exchange Linen Trolley ..... 36, 37, 242
  - Executive Service Cart ..... 41
  - Expanding Barriers ..... 292, 293
  - Expanding Conveyors ..... 232, 233
  - Export Pallets ..... 135
  - Extension Fork Slippers ..... 210
  - EZ Loader Pallet Positioner ..... 187
- F**
- Fan ..... 121
  - Fence - Expanding ..... 292, 293
  - Fence - Pedestrian ..... 288, 289
  - Fibreglass Ladders ..... 159
  - Filling Frame ..... 169
  - File Trolley ..... 45
  - Fischer Bins ..... 122, 124
  - Fixed Bollards ..... 284, 285
  - Flammable Storage - Aerosol Cans ..... 282
  - Flammable Storage - Gas Cylinders ..... 280, 281
  - Flammable Storage - Liquids ..... 276, 277
  - Flexible Barriers ..... 290, 292, 293
  - Flexible Conveyor ..... 232, 233
  - Floor Angles ..... 294
  - Floor Brush ..... 240, 241
  - Floor Marking Stickers ..... 300
  - Floor Pallet Scales ..... 120
  - Floor Sweeper ..... 237
  - Folding Cart ..... 11, 16, 42, 242, 11
  - Folding Handle Trolley ..... 8, 9, 11, 42
  - Folding Lifting Platform Trolley ..... 174, 175, 178
  - Folding Stillage Cage ..... 140, 141, 142, 146, 147
  - Folding Trolleys ..... 131, 134, 136, 137
  - Food Grade Crates ..... 131, 134, 136, 137
  - Foot Pedal Lid Lifting Wheelie Bins ..... 247
  - Foot Stools ..... 158
  - Forklift Crane Bins ..... 256, 260, 261, 262
  - Fork / Platform Trolley ..... 198, 200
  - Fork Slippers ..... 210
  - Forklift Spreader ..... 212, 214
  - Fork Spreader Beam ..... 214
  - Fork Stackers - Electric ..... 198
  - Fork Stackers - Manual ..... 198, 199, 200, 201
  - Forklift - Manual ..... 201
  - Forklift Attachment - Bin Tipper ..... 250, 251
  - Forklift Attachment - Lifting Jibs ..... 216, 217
  - Forklift Attachment - Roll Prongs ..... 210
  - Forklift Attachment - Safety Cage ..... 149
  - Forklift Attachment - Slippers ..... 210
  - Forklift Attachment - Spreader ..... 212, 214
  - Forklift Attachment - Steel Bins ..... 55, 257, 258, 259, 260, 261, 264, 265
  - Forklift Attachments - Drum Handling ..... 224, 225, 226, 227
  - Forklift Bins ..... 55, 257, 258, 259, 260, 261, 264, 265
  - Forklift Drum Grab ..... 225, 226
  - Forklift Drum Rotator ..... 224, 225, 227
  - Forklift Drum Tipper ..... 225
  - Forklift Gas Storage Cage ..... 281
  - Forklift Ramps ..... 162, 163, 164
  - Forklift Safety Cage ..... 194
  - Forklift Sweeper ..... 236
  - Forklift Tine Hook ..... 212
  - Forklift Wheel Stop ..... 295
  - Forklift Wheelie Bin Tipper ..... 205
  - Full Height Cupboards ..... 98, 114
  - Furniture Dolly / Mover ..... 62
  - Furniture Hand Trucks ..... 44, 63
- G**
- Galvanised Pallet Trucks ..... 206
  - Galvanised Scissor Lift Trolley ..... 179
  - Garbage Bins ..... 244, 245, 247-249, 256-258
  - Garbage Bin Stands ..... 246
  - Gas Cylinder Cage ..... 273, 278, 280
  - Gas Cylinder Rack ..... 272
  - Gas Cylinder Storage ..... 45, 46, 272, 273, 278, 280, 281
  - Gas Cylinder Trolleys ..... 45, 46, 272
  - Gate ..... 291
  - Geared Drum Lifter ..... 224
  - Genie Lift (Similar) ..... 199
  - Glass Trolley ..... 49
  - Goods Cages ..... 138-147
  - Goods Trolleys ..... 78, 79
  - Gravity Conveyor ..... 232-235
  - Guard Rail Fencing ..... 286, 287
- H**
- Half Height Cupboard ..... 98, 99, 114
  - Handrail ..... 288, 289
  - Hand Truck - Aluminium ..... 42, 43, 200
  - Hand Truck - Stair Climber ..... 44
  - Hand Trucks / Trolleys ..... 8-89
  - Hardware Trolley ..... 11, 28, 29, 48, 65
  - Harness ..... 149
  - Hazardous Material Storage ..... 275-283
  - Healthcare Storage Bins ..... 122-125
  - Healthcare Trolleys ..... 30-35
  - High Density Drawer Cabinets ..... 92, 96-101, 106, 107
  - Hi-Lift Pallet Truck ..... 209
  - Hook - Pallet ..... 214, 215
  - Hook and Tow Jib ..... 217
  - Hook Drum Lifter ..... 223
  - Hooks For Pegboard ..... 128
  - Hospital Storage Bins ..... 122-125
  - Hospital Trolleys ..... 30-35
  - Hospitality Trolleys ..... 35-41
  - Housekeeping Cart ..... 16, 17, 33, 36, 37, 39, 41
  - Hydraulic - Jack ..... 195
  - Hydraulic Drum Truck ..... 222
  - Hygiene Pallet ..... 135
- I**
- IBC Bundled Pallets ..... 267
  - IBC Containers ..... 266
  - IBC Spill Bins ..... 268
  - IBC Tilting Stand ..... 191
  - IBC Trolley ..... 191
  - Industrial Drawer Unit ..... 97-101
  - Industrial Fan ..... 121
  - Industrial Hand Trucks ..... 8-89
  - Industrial Storage Cabinets ..... 92, 94, 96-101, 105-107, 114, 117, 172, 275-277
  - Industrial Workbenches ..... 104-111
  - Instrument Trolley ..... 30-32
- J**
- Jack - Hydraulic ..... 195
  - Janitors Carts ..... 36, 54, 55, 57, 242, 243
  - Jib - Forklift Attachment ..... 213, 216, 217
- K**
- Keg Trolley ..... 44
  - Kibble - Concrete ..... 168



- L**
- Ladder - Fibreglass .....159
  - Ladder Trolley .....29, 84-89
  - Laundry Trolley .....36, 242
  - Legal File Trolley .....45
  - Library Trolleys .....77, 80, 81
  - Lid Lifting Bin .....245, 247, 248
  - Lift Assist Device .....200
  - Lift Stacker - Electric .....198, 209
  - Lift Stacker - Manual .....198-201
  - Lift Tables .....182-186, 189
  - Lift Trolleys .....174-181
  - Lifters - Genie .....199
  - Lifting Equipment .....174-231
  - Linen Trolleys .....36, 37, 242
  - Load Skates / Rollers .....90, 91
  - Lockable Storage Cage .....278, 279
  - Lockable Trolleys .....37, 39, 71-74
  - Longspan Bin Rack .....132, 133
  - Longspan Packing Bench .....104
  - Longspan Shelving .....152-154
  - Louvre Panel / Pegboard Trolley .....95
  - Louvre Panel Bins .....122, 124, 125
  - Louvre Panels .....95, 128, 129
  - Low Profile Pallet Truck .....204, 205
  - Low Profile Scissor Lift Table .....183
  - LPG Cylinder Storage .....280, 281
- M**
- Machine Guarding .....284-293
  - Mail Trolleys .....16, 17, 21-23, 65
  - Maintenance Trolleys .....60, 61, 64
  - Man Cage - Forklift .....149
  - Manual Bin Tipper .....254
  - Manual Fork Stacker .....201
  - Materials Handling Tug .....196
  - Matting - Anti-Fatigue .....103
  - Meat Crate / Tubs .....131, 134, 136, 137
  - Medical Storage Bins .....122-125
  - Medical Trolleys .....30-35
  - Mega Bins .....137
  - Mega Bin Rotator Base .....137
  - Mesh Cages .....138-143, 278-280
  - Mesh Decks for Pallet Racking .....157
  - Mesh Drop Bottom Bin .....265
  - Mesh Trolley .....22, 23, 37, 70-80
  - Mesh-Pak Storage Bins .....124
  - Metal Bollard .....284, 285
  - Metal Louvre Panel / Pegboard .....128, 129
  - Metal Step Stool .....158
  - Microbins (Similar) .....95, 122-127
  - Mobile Ladders .....159-161
  - Mobile Tool Trolleys .....60, 61, 94
  - Mobile Work Positioner .....192-194
  - Mobile Workbenches .....104-107
  - Multi-Deck Trolleys .....12, 16-20, 22, 23, 26-32
  - Multistaka Crates .....134
- N**
- Nally Bins .....137
  - Nesting Crates / Bins .....95, 122, 124, 130, 131
  - Nesting Trolleys .....11, 66, 67
  - No. 4, 4D, 7, 10, 15 Bins .....130, 131
  - Nylon Skate Conveyor .....233
- O**
- Office Trolley .....11, 12, 16, 17, 18-25
  - Order Picking Ladder .....25, 29, 75, 84-89, 158, 159
  - Order Picking Trolley .....21-24, 26, 27, 57-59, 69-76
  - Otto Bins .....247, 248
  - Oxygen Bottle Trolleys .....45, 46, 272
- P**
- Packing Bench .....104
  - Paint Storage Cabinets .....276, 277
  - Pallecon Tilter .....271
  - Pallet - Plastic .....135
  - Pallet Bin .....136, 137
  - Pallet Cages .....142, 143
  - Pallet Dispenser .....118
  - Pallet Elevator .....188
  - Pallet EZ Loader .....187
  - Pallet Hooks .....214, 215
  - Pallet Jack .....203-209, 222
  - Pallet Loading Trolley - For Drums .....213
  - Pallet Positioners .....187-191
  - Pallet Racking Mesh Decks .....157
  - Pallet Racking Protectors .....157
  - Pallet Rotator .....202
  - Pallet Scales .....120
  - Pallet Stands .....190, 191
  - Pallet Straighteners .....155
  - Pallet Tables .....182-191
  - Pallet Tilter .....191, 271
  - Pallet Truck .....203-209, 222
  - Pallet Truck - Electric .....203, 209
  - Pallet Truck - Hi-Lift .....209
  - Pallet Truck - With Scales .....207
  - Pallet Turntable .....194
  - Pallet Wrapper .....119
  - Palomat .....118
  - Palring .....202
  - Panel Cart .....49-53
  - Parcel Scales .....120
  - Parrot Beak Drum Lifter .....226
  - Parts Bin Trolley .....93
  - Parts Cabinets .....117
  - Parts Trays / Boxes .....116, 117, 122, 123
  - Pedestrian Control .....288-294
  - Pedestal Fan .....121
  - Pegboard .....128, 129
  - Pegboard Trolleys .....95
  - Pegboard Accessories .....128
  - Picking Trolley .....21-24, 26, 27, 57-59, 69-76
  - Pipe Trolley .....46
  - Plastic Bin Racks .....132, 133
  - Plastic Bin Trolleys .....54, 55, 57, 243
  - Plastic Bins .....242-245
  - Plastic Crate Dollies .....130
  - Plastic Crates .....130-134, 136, 137
  - Plastic Drum Carrier / Rotator .....219
  - Plastic Drum Palletiser .....221
  - Plastic Drum Trolley .....220
  - Plastic Louvre Panel .....129
  - Plastic Mega Bins .....136, 137
  - Plastic Pallet Bins .....136, 137
  - Plastic Pallets .....135
  - Plastic Parts Trays .....116, 117, 123
  - Plastic Step Stools .....158
  - Plastic Storage Bins .....93, 95, 116, 117, 122-125, 130-134
  - Plastic Trolleys .....16, 17, 36, 38-41, 54, 55, 57, 62, 242, 243
  - Plastic Waste Bins .....242-245, 247-249
  - Platform Ladders .....159-161
  - Platform Scales .....120
  - Platform Stacker .....198
  - Platform Trolley - Stainless Steel .....33
  - Platform Trolleys .....8-12
  - Pneumatic Scissor Lift Tables .....186

**P continued on page 315**

**P Continued**

Poly Pallet	135
Portable Barriers	290, 292, 293
Post / Rail Barriers	288, 289
Post Bollards	284, 285
Powered Conveyor	233
Powered Dump Truck	15
Powered Scissor Lift Table	184, 185
Powered Scissor Lift Trolley	176, 180, 181
Powered Trolley	14, 15, 180, 181
Pressure Pack Storage	282, 283
Produce Crates / Bins	130, 131, 136, 137
Pull Cord Forklift Wheelie Bin Tipper	250, 251
Pull Cord Waste Bin	258, 259

**R**

Racking - Longspan	152-154
Racking - Workbench	104
Racking Protectors	290
Rain Cover - Court File Trolley	45
Ramps - Container	162-165
Recycled Plastic Crate	130
Reel Handlers	192
Relocatable Dangerous Goods Stores	276, 277
Retail Trolley	64-67
Retractable Barriers	
Rigging Racks	170, 278
Roll Cage Trolley	66, 67
Roll Prong / Handler	210
Rolled Upright Shelving	116
Roller Conveyor	232-234
Roller Load Skates	90, 91
Rolling Ladder	159
Rolling Step Stool	158
Rotator Base	137
Rotator Ring	202
Rough Terrain Pallet Truck	208
Rough Terrain Scissor Lift Trolley	175
Rough Terrain Trolley	48
Round Plastic Waste Bin	244, 245
Rubbish Bin	242-249
Rubbish Carts	242

**S**

Safety Barriers	286-293, 297
Safety Bollards	284, 285, 296
Safety Cabinet	276, 277
Safety Cage	149, 150
Safety Chains	302
Safety Gate	291
Safety Guard Rail Fencing	286, 287
Safety Harness	149
Safety Matting	103
Safety Steps	158
Safety Tags	302
Scales	120
Scissor Lift Table	182-189
Scissor Lift Trolley	174-181
Scooter Trolley	57
Scrap Bin	255-265
Security Trolleys	80, 83
Self Dumping Tipping Bins	260, 261
Self Levelling Table	188
Self Levelling Trolley	28
Self Propelled Trolley	180, 181
Service Carts	33-41
Shadow Board	238
Shadow Board Trolleys	95
Shelf Trolley	18-20, 26-30, 33-35, 38-41
Shelving - Access Bins	132, 133
Shelving - Longspan	152-154
Shelving - Steel	153, 153
Shifting Load Skates	91

Shipping Scales	120
Shopping Trolley	16, 17
Side Shift Drum Palletiser	228
Single Scissor Lift Trolley	174-179
Site Tool Box	173
Site Tool Cabinet	172
Skate Conveyor	232
Skates	90, 91
Skip Bins	260, 261
Slippers - Forklift	210
Sloping Shelf Trolley	81
Small Parts Bins	93, 117, 122
Small Parts Cabinet	117
Soiled Linen Trolleys	37
Solicitors Trolley	45
Spare Part Trays	123
Spill Bin	47, 268, 269, 273
Spill Kit	274
Spill Pallet for Drums	267
Spray Can Storage	282, 283
Spreader - Forklift Attachment	212, 214
Spring Loaded Pallet Positioner	188
Spring Loaded Tilting Stand	271
Spring Scissor Lift Trolley	179
Springer Trolley	28
Square Hole Board	61, 95, 128
Squeegee	238, 240
Stack & Nest Crates	130, 131
Stackable Fork Bins	136
Stackable Storage Cage	138-141, 144-147
Stainless Steel Instrument Trolleys	30-32
Stainless Steel Pallet Trucks	206-207
Stainless Steel Scissor Lift Trolley	178
Stainless Steel Trolleys	32-35
Stainless Steel Work Positioner	193
Stair Climbing Hand Truck	44
Stand - Cabinet	98, 99
Stand - Tilting	191
Steel Bollards	285
Steel Drum Carrier / Rotator	218-231
Steel Drum Palletiser	221-228
Steel Drum Trolley	218-222, 273
Steel Shelving	98, 114-117, 152-154
Steel Waste Bin	257-261
Steel Waste Trolley	257
Step Ladder	158-161
Step Ladder Trolley	25, 29, 75, 84-89
Step Stools	158
Stillage Cages	138-148
Stirrups	211
Stock Trolleys	64, 66-67
Stool - Foot / Step	158
Stool - Chair	102
Storage - Dangerous Goods	266-283
Storage Bins - Plastic	244-249, 255
Storage Cabinets / Cupboards	96-101, 105-107, 114, 117
Storage Cages - Mesh	138-143, 146, 147
Storage for Drums	267-269, 273, 275-277
Stor-Pak Bins	122-125
Straddle Leg Stackers	201
Straight Bollards	284, 285
Strapping Machine	119
Stretch Wrapping Machine	119
Sweeper	236-240
Swing Gate	291





**T**

Table Lifters	183
Tier Trolleys	18-35
Tier Trolleys - Stainless Steel	30-35
Tilt Trucks	15
Tilting Jibs	217
Tilting Stand	191
Timber Deck Trolley	48
Tine Extensions	210
Tipppers For Bins	250-254
Tool Board	128
Tool Board Trolleys	95
Tool Cabinets / Workstations	96
Tool Cabinet - Site	172
Tool Holders	94, 95, 128
Tool Trolleys	60, 61, 92-96
Tow Tug	197
Trailer Stand	195
Transport Cages	138-143, 146, 147
Tray - Concrete Collection	166
Trays - Small Parts	123
Trolley - Aluminium	10, 16, 17
Trolley - Basket	11, 16, 17, 22, 23, 27, 37, 64, 65, 87
Trolley - Cage	66-89
Trolley - Cleaning	36, 54, 55, 57, 242, 243
Trolley - Court	45
Trolley - Cylinder	45, 46, 272
Trolley - Drum Handling	47, 218, 220, 221, 273
Trolley - Folding	16, 17, 42
Trolley - Hand Truck	8-89
Trolley - Keg	44
Trolley - Lifting	174-181
Trolley - Linen	36, 37, 242
Trolley - Office	11, 12, 16, 17, 18-25
Trolley - Panel Cart	49-53
Trolley - Plastic Bin	21, 22, 24, 37, 57-59
Trolley - Platform	8-12
Trolley - Scissor Lift	174-181
Trolley - Shopping	16, 17
Trolley - Stainless Steel	32-35
Trolley - Wire Mesh	70-74, 80-87
Trolley - With Clipboard / Writing Shelf	29, 57-59
Trolley - With Doors	66, 67, 71-74, 78-80, 82, 83, 85
Trolley - With Folding Side / Lid	71
Trolley - With Pneumatic / Flat Free Wheels	12-15, 20-25, 43-45, 48, 50-53, 57, 69-75, 76, 78-81, 83
Trolley - With Removable Side	72
Truck Access Platform	159-161
Truck Unloading Ramp	165
T-Top Bollards	298
Tub Trolley	21, 22, 24, 58, 59
Tug	
Turntable - Pallet	202
Turntable - Stand	191
Turntable - Wrapping	202

**U**

U Bar Bollards	284
Under Bench Storage	105-107
Utility Cart	38-41

**V**

V-Cart	16, 17
Vacuum Cleaners	237
Vehicle Safety Barriers	286, 287
Vented Bins	136, 137
Visi-Pak Bins	125

**W**

Wagon Platform Truck	48
Walk-Behind Electric Pallet Truck	203
Wall Mount Barriers	290

Warehouse Ladders	158-161
Warehouse Packing Bench	104
Waste Bin - Plastic	244, 245, 247-249
Waste Bin - Steel	256
Waste Bin / Cart	36, 242
Waste Drum Tipper	225
Waste Tipping Bin	257-261
Waste Trolley	36, 54-55, 57, 242-243, 257
Weighing Equipment	120
Wet & Dry Vacuum Cleaners	237
Wheel Conveyor	232-235
Wheelie Bin Stands	246
Wheelie Bin Tipppers	250-254
Wheelie Bins	247-249, 255
Wheel Chock	303
Wire Basket Trolleys	70-74
Wire Cages	142
Wire Mesh Decks	157
Wire Mesh Trolley	37
Work Platforms	149, 159-161
Work Positioner	192-194
Workbenches	104-113
Workshop Cabinets	92, 94, 96-101, 105-107, 114, 117, 172, 275-277
Workshop Matting	103
Workshop Trolleys	92
Workstation	96
Wrapping Machine	119

**X**

X Shape Cart	16, 17, 36, 242
--------------	-----------------

**Y**

Yard Ramp	165
-----------	-----



Verdex Equipment Pty Ltd  
 ABN: 66 640 439 149  
 Warehouse Address: 23 Hawthorne Ave,  
 Marsden Park NSW 2765  
 Postal Address: PO Box 4052, Carlingford  
 North NSW 2118  
 Tel: (02) 8866 4600  
 Fax: (02) 8866 4620  
 Email: sales@verdex.com.au  
 Bank: Westpac  
 BSB No: 032-080  
 Account No: 630470

## ACCOUNT APPLICATION FORM

### PLEASE COMPLETE FORM IN FULL

COMPANY NAME			
HEAD OFFICE ADDRESS			
ABN NUMBER		HEAD OFFICE TELEPHONE NUMBER	
NO. OF PEOPLE EMPLOYED		YEAR BUSINESS COMMENCED	
TYPE OF BUSINESS			
CREDIT LIMIT REQUIRED		ESTIMATED MONTHLY PURCHASES	

#### Account Contact Details

ACCOUNTS EMAIL ADDRESS	
ACCOUNTS CONTACT PERSON	
ACCOUNTS PHONE	
POSTAL ADDRESS	

#### Primary Contact Person

EMAIL ADDRESS			
CONTACT NAME			
PHONE		MOBILE	
POSTAL ADDRESS			
DELIVERY ADDRESS			

#### Alternative Contact Person

EMAIL ADDRESS			
CONTACT NAME			
PHONE		MOBILE	
POSTAL ADDRESS			
DELIVERY ADDRESS			

#### Trade References (please supply 3 references)

COMPANY NAME		CONTACT NAME	
EMAIL		PHONE	
COMPANY NAME		CONTACT NAME	
EMAIL		PHONE	
COMPANY NAME		CONTACT NAME	
EMAIL		PHONE	

#### ACKNOWLEDGEMENT

I, (Print Name) ..... acknowledge that the above information is true and correct.

SIGN HERE ..... POSITION HELD WITHIN THE BUSINESS .....

DATED ON BEHALF OF THE CUSTOMER .....

**IN APPLYING FOR CREDIT, I AGREE ON MY/THE CUSTOMERS BEHALF, TO VERDEX EQUIPMENTS TERMS AND CONDITIONS**

## Return Process:

### STEP 1

Email our team within 14 days of receiving your order with the following information:

- Photo of item
- Reason for return
- Order number

### STEP 2

Our team will access the information you have provided & will evaluate your claim

**Please wait for further instructions**

### STEP 3

Once claim is approved & depending on your specific circumstance:

**Collection of the goods will be organised**

*To be eligible for a return, you must submit your claim within 14 days of receiving your order. The item(s) must be unused, undamaged & in their original packaging. To start the return process, contact our customer support team within the specified return period & provide the necessary details. Our team will evaluate your claim & give you further instructions. For more information on our returns process visit: <https://www.verdex.com.au/page/returns-policy/>*

## Spare Parts

We believe in doing all we can to reduce manual handling efforts & equip your workplace which is why we offer spare parts to suit your specific requirements.

*Whether you have previously purchased from our range or already own a similar product, we can provide any extra accessory or part which may be required. Get in touch with our team today to discuss the best solution for your particular circumstance.*

## Examples of Spare Parts Include:

- Handles
- Shelves
- Platforms
- Circuit Boards
- Hydraulic Rams
- Chains
- Switches
- Springs
- Batteries
- Castors

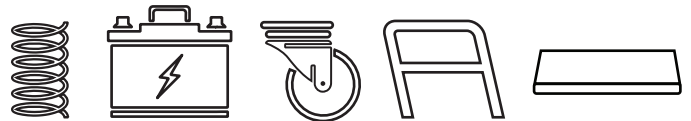

## Warranty

For a period of 12 months from date of delivery, Verdex warrants to the original purchaser of the equipment. If goods are delivered in a defected state, claims must be made within 14 days. Batteries, castors, wheels & tyres that have normal wear are not included & have a period of 3 months warranty from date of delivery.

Verdex Equipment's warranty is a back to base warranty, meaning it is the customer's responsibility to return the faulty goods to the store of purchase. Verdex Equipment will then assess the item & repair or replace the faulty item as deemed suitable.

## Not covered by warranty:

- Hydraulic hoses, electrical cabling & wheels
- Consumables such as globes or similar items
- Any alterations to the equipment
- Any parts not provided by Verdex Equipment



*Negligence, abuse, misuse, overloading, failure to follow instructions supplied with purchase (if not supplied, must be requested), will void warranty.*



# GENERAL TERMS AND CONDITIONS

1. SELLER means VERDEX EQUIPMENT PTY LTD ABN 66 640 439 149 and BUYER means the Buyer whose order for the purchase of goods is accepted by Seller.
2. ACCEPTANCE OF BUYER'S ORDER: These terms and conditions shall apply to every sales contract and sale of goods between Seller and Buyer; any terms and conditions of Buyer's order deviating from or inconsistent with these Terms are expressly rejected by Seller. This rejection also extends to any statements by Buyer that Buyer's terms and conditions shall prevail and to any stipulation by Buyer as to the manner of declaring such rejection. A contract shall only be or be deemed to have been entered into between Seller and Buyer for the supply of goods when, upon an order having been placed upon Seller for goods, that order has been accepted by Seller. (Such acceptance of order may be made and communicated by Seller in writing or by overt act of acceptance.) The provisions of this clause 2 shall apply to every quotation or offer by Seller for the supply of goods.
3. PRICES: All prices are listed in our quotations and website exclude 10% GST. Prices listed and/or quoted are subject to change or alteration without notice. Quotations are to be treated as estimates only and subject to withdrawal, correction or alteration at any time before acceptance of Buyer's order by Seller.
4. INSURANCE: Buyer is responsible to effect whatever insurance cover he requires at his expense.
5. PRODUCTS: Products pictured in our product catalogue or on our quotations are to be used as a guide only. Products may be substituted for as close as possible equivalent if they become unavailable.
6. FREIGHT PRICES: Standard freight prices are calculated on our website to your postcode. Extra freight charges will apply for bulky, large or long items however we will confirm this with you prior to processing your order. Freight charges to regional and all other areas may have some additional fees.
7. PAYMENTS: Payments can be made via credit card or direct deposit. If the Seller shall extend credit to Buyer, payment for all goods sold will be within thirty (30) days from the last day of the month in which each delivery was made. Interest shall be payable by Buyer on all amounts overdue to Seller at the rate of two (2) per centum per month. Buyer is liable for all expenses incurred by Seller in recovering the debt.
8. CANCELLATION: Orders accepted by the Seller cannot be countermanded or delivery deferred or goods returned except with the written consent of Seller and upon terms that reimburse and indemnify Seller against all loss including cartage, bank charges and other incidental expenses on any part of the order that is cancelled. Where Seller agrees to accept goods for return a re-stocking charge of 20% may apply of the price of the goods returned.
9. ACCEPTANCE OF CLAIMS: Acceptance of the goods delivered shall be deemed for all purposes to have taken place at the expiration of seven (7) days from the date of each delivery.
10. DELIVERY AND RISK: Unless the Buyer has requested Seller to make special delivery arrangements the risk in respect of the goods shall pass to the Buyer upon delivery to the Buyer's premises or the nominated carrier's depot. The Buyer shall provide or cause to be provided full and clear access for delivery and will at its own expense provide all necessary assistance in unloading the goods at the nominated place of delivery. Seller will not in any circumstances accept liability for damage, shortage or loss during transit. If delivery of the goods by Seller is delayed for a cause other than its own negligence the Buyer shall be liable for extra charges, losses or expenses incurred by Seller and the Buyer shall not be entitled to cancel the order by reason thereof.
11. SPECIAL ORDERS: Buyer will place order in writing to Seller for non-standard and customised items. Seller will not accept return of these items unless the manufacturer agrees to accept return from Seller. Seller may deduct transport handling and restocking charges of 20% of the price of the goods from the credit due to Buyer.
12. RISK AND PROPERTY: The risk in the goods or services sold shall pass to Buyer at the point of delivery. This shall also apply to any partial delivery of goods. If delivery of goods is delayed due to any circumstances beyond the control of Seller the risk passes to Buyer on the day regarded as date of delivery. The Seller accepts no responsibility for the misuse or improper use of goods or products supplied. The Buyer accepts the full responsibility for any damage or injury either to property or persons caused by the products or services supplied by the Seller.
13. PERSONAL PROPERTIES SECURITIES ACT 2009 (PPSA): The Buyer hereby acknowledges that these Terms and Conditions of Trade constitute a security agreement which creates a security interest in favour of the Seller in all Goods previously supplied by the Seller to the Buyer (if any) and all after acquired Goods supplied by the Seller to the Buyer (or for the Buyer's account) to secure the payment from time to time and at a time, including future advances. The Buyer agrees to grant a "Purchase Money Security Interest" to the Seller. The Buyer acknowledges and agrees that by assenting to these terms the Buyer grants a security interest (by virtue of the retention of title clause in these Terms and Conditions of Trade) to the Seller and all Goods previously supplied by the Seller to the Buyer (or for the Buyer's account) and these terms shall apply notwithstanding anything express or implied to the contrary contained in the Buyer's purchase order. The Buyer undertakes to;
  - (i) sign any further documents and/or provide any further information (which information the Buyer warrants to be complete, accurate and up-to-date in all respects) which the Seller may reasonably require to enable registration of a financing statement or financing change statement on the Personal Property Securities Register ("PPSR");
  - (ii) not register a financing change statement of the PPSA or make a demand to alter the financing statement pursuant to the PPSA in respect of the Goods without the prior written consent of the Seller.
  - (iii) give the Seller not less than 14 days written notice of any proposed change in the Buyer's name and/or any other changes in the Buyer's details (including by not limited to changes in the Buyer's address, facsimile number, email address, trading name or business practice);
  - (iv) pay all costs incurred by the Seller in registering and maintaining a financing statement (including registering a financing change statement) on the PPSR and/or enforcing or attempting to enforce the security interest created by these Terms and Conditions of Trade including executing subordination agreements;
  - (v) be responsible for the full costs incurred by the Seller (including actual legal fees and disbursements on a solicitor and client basis) in obtaining an order pursuant to section 182 of the PPSA; and the Buyer waives any rights it may have under sections 115 of the PPSA upon enforcement. Pursuant to section 157 of the PPSA, unless otherwise agreed to in writing by the Seller, the Buyer waives the right to receive the verification statement in respect of any financing statement or financing change statement relating to the security interest. The Buyer agrees that immediately on request by the Seller the Buyer will procure from any persons considered by the Seller to be relevant to its security position such agreement and waivers as the Seller may at any time require.
14. DELIVERY TIME: Seller may deliver the goods by instalments or partial shipments and Buyer will accept each delivery. Requirements of Buyers shall not be a condition or of the essence of the sale. Seller shall be under no liability for direct or consequential loss or damage to Buyer arising from delay or postponement in delivery.
15. WARRANTY: Goods sold shall only have the benefit of a manufacturer's warranty if the purchaser has complied with the manufacturer's instructions in relation to maintenance and operation of the goods sold. Sellers liability in respect of a breach of a consumer guarantee for any goods not of a kind ordinarily acquired for personal, domestic or household use is limited to, to the extent permissible by law and at the Seller's option in relation to the goods.
  - (i) The replacement of the goods or the supply of an equivalent;
  - (ii) The repair of the goods;
  - (iii) The payment of the cost of replacing the goods or acquiring equivalent goods, or the payment for the cost of having the goods repaired. The exemption, limitations, terms and conditions in these Terms apply whether or not the loss or damage is caused by negligence or actions constituting fundamental breach of contract. The Seller is not otherwise liable for any direct, indirect or consequential loss or damage howsoever arising or occurring, whether founded in tort, contract, statute or otherwise. Goods returned by Buyer to Seller for repair will be free of all charges to Seller and at Buyer's risk.
16. NO IMPLIED SERVICE: The Buyer acknowledges that excepting as provided by law this agreement does not entitle the Buyer to demand to receive from us any site inspection or service of the goods supplied, delivered and installed if applicable. If the Buyer does require our services in respect of site inspection and service of the goods, the subject of this agreement, then the Buyer should arrange with us to enter a separate agreement in respect of same. In the event that no separate agreement in relation to site inspection and service is required by the Buyer, then the Buyer acknowledges that in the event of the goods supplied required to be serviced or inspected due to breakdown or otherwise, then the Buyer shall rely solely on any benefit in respect of same provided by the manufacturer.
17. COUNCIL APPROVAL: Our products make no allowances for building or development application or Fees to Council or relevant approvals for use required by Council or Government Codes. Responsibility is solely on the Buyer for such approvals for goods and their installation or use.
18. CLERICAL ERRORS: Clerical errors in computations, typing or otherwise in our product catalogue or quotation shall be subject to correction. Errors and omissions excepted.
19. MODIFICATIONS: All modifications and amendments to these Terms and Conditions shall be in writing and if otherwise shall not be binding upon Seller.
20. If any of the provisions of the Contract are unlawful or invalid by reason of any applicable statute or rule of Law, then such provision shall be severed from the rest of this Contract which shall remain valid and binding on the parties.

E.& O.E (Images and specifications subject to change or alteration without notice. Please check our website for up to date details)

# EQUIPPING WORKPLACES

Delivering Australia Wide Daily



## WAREHOUSE LOCATIONS

### Melbourne

43 Zenith Road,  
Dandenong South, VIC 3175

**Get in Touch:**  
(03) 9115 9100  
[sales@verdex.com.au](mailto:sales@verdex.com.au)

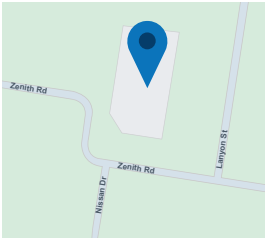

### Sydney

23 Hawthorne Avenue,  
Marsden Park, NSW 2765

**Get in Touch:**  
(02) 8865 1800  
[sales@verdex.com.au](mailto:sales@verdex.com.au)

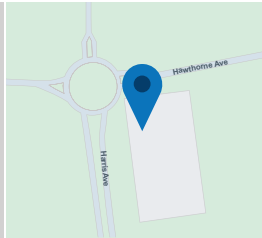

### Brisbane

42 Mineral Sizer Court,  
Narangba, QLD 4509

**Get in Touch:**  
(07) 3558 9700  
[sales@verdex.com.au](mailto:sales@verdex.com.au)

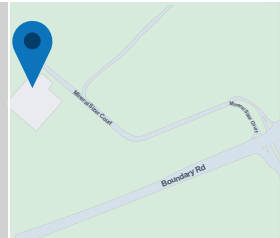

# VERDEX

EQUIPPING WORKPLACES

**Edition 25**  
**1800 750 500**  
[www.verdex.com.au](http://www.verdex.com.au)



**VERDEX** Incorporates **MHA**

© Verdex Equipment Pty Ltd ABN 66 640 439 149