

# Workplace Equipment

**VERDEX**  
Incorporates **MHA**



## Steerable Load Skates

- The steerable skate can be used to move heavy objects up to 12000kg
- The rubber padded platform swivels on a thrust bearing allowing easy movement around corners
- V1330 & V1335 have nylon roller wheels
- V1340 has steel roller wheels



Code	Details	Load Capacity (kg)	Castors Dia. (mm)	Castors Width (mm)	Pad Size (mm)	Base Size LxWxH (mm)	Unit Weight (kg)
V1330	Steerable Load Skate	3000	85	90	180x150	230x185x105	15
V1335	Steerable Load Skate	6000	85	90	400x220	550x590x120	45
V1340	Steerable Load Skate	12,000	80	85	400x220	560x585x120	66

## Equipment Roller Skates

- Ideal for linear motion, repetitive movement or use as a built in component in equipment
- Fixed hole pattern for bolt mounting
- The rollers can be used in up down or sideways position

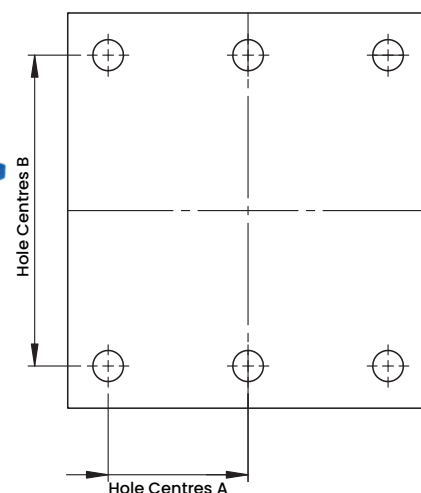

Code	Details	Load Capacity (kg)	Hole Centres A (mm)	Hole Centres B (mm)	Overall Size LxWxH (mm)	Unit Weight (kg)
V1350	Roller Skates	750	64	140	165x178x80	5
V1355	Roller Skates	2500	64	140	165x180x90	10
V1360	Roller Skates	5000	83	171	203x203x80	15
V1365	Roller Skates	15,000	94	216	270x254x100	21





## Roller Load Skates

- These skates are designed to move heavy loads e.g machinery and heavy workshop equipment up to 10 tonnes.
- Available with diamond steel top or rubber pad top which protects items from scratching.
- Optional steering handle available
- Turntable is lockable
- Number of Rollers: 14
- Handle Length: 1310mm
- Rotating Top Diameter: 145mm



Code	Details	Load Capacity (kg)	Overall Size LxWxH (mm)	Unit Weight (kg)
V1300	Roller Load Skate - Diamond Steel Top	10,000	270x150x135	17
V1301	Roller Load Skate - Rubber Pad Top	10,000	270x150x125	17
V1302	Steering Handle to Suit V1300 & V1301			7

## Load Shifting Skates 2.5 Tonne & 6 Tonne Capacity

- These shifting skates can be used wherever heavy objects need to be moved
- Large diameter nylon rollers ensure ease of movement and spread the load to protect floors from damage caused from high load points
- Fitted with a rubber surface to protect the objects being moved



Code	Details	Load Capacity (kg)	Castors (mm)	Overall Size LxWxH (mm)	Unit Weight (kg)
V1310	Shifting Skates (2 x Rollers)	2,500	2 x 85	210x100x105	4
V1315	Shifting Skates (6 x Rollers)	6,000	6 x 85	412x210x105	12

## Pegboard Tool Trolley

- Great tool trolley for general workshop use
- Comes with metal pegboard on back as well as the sides which can be used to hold tools and equipment
- Powder coated light grey finish
- 75mm rubber castors - 2 x fixed, 2 x swivel with brakes



Code	Load Capacity (kg)	Handle Height (mm)	Shelf Heights (mm)	Shelf Size (mm)	Back Panel Size (mm)	Overall Size LxWxH (mm)	Unit Weight (kg)
V7225	250	825	160 + 510 + 900	595x405	605x440	670x415x1730	43.5

## Industrial Tooling Cabinet on Wheels

- Heavy duty tooling cabinets are ideal for industrial applications and workshops
- The sliding drawers are a welded strengthened single rail design coupled with high quality mechanical bearings for long lasting smooth operation
- Each drawer is rated at 100kg load capacity with 97% access
- Single key lock design for safe storage. Each drawer has a mechanical safety lock which allows one drawer to be opened at a time, preventing the cabinet from tipping over
- Rubber castors - 2 x fixed, 2 x swivel with brakes
- All drawers come with adjustable steel dividers
- 6 Drawers:
  - 2 Drawers x 75mm
  - 2 Drawers x 100mm
  - 2 Drawers x 150mm



Code	Load Capacity (kg)	Castors (mm)	Overall Size LxWxH (mm)	Unit Weight (kg)
V7215	500	125	565x580x900	76





# Parts Bin Trolley

- PVC mat on top and bottom tray
- Transparent front window on the parts bin
- Each bin comes with one divider and one bin label card
- Parts trays have a raised back lip
- Plastic Parts Bin size (LxWxH): 450x165x105mm
- 265mm distance between bottom and middle shelf on V7226 model
- Load capacity: 400kg
- Rubber castors – 2 x fixed, 2 x swivel with brakes



V7226



V7227

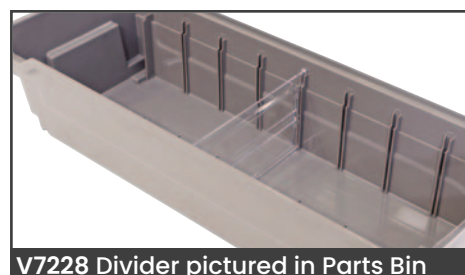
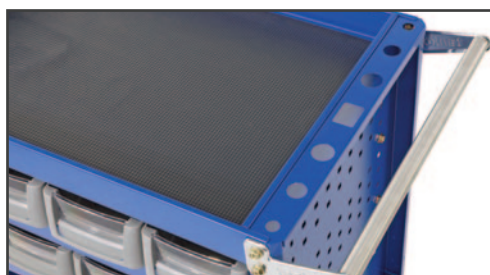

V7228 Divider pictured in Parts Bin

Code	Details	Castors (mm)	Distance Between Shelves (mm)	Shelf Size (mm)	Overall Size LxWxH (mm)	Unit Weight (kg)
V7226	Parts Bin Trolley (8 parts bins)	100	110	755x465	850x500x855	34
V7227	Parts Bin Trolley (16 parts bins)	100	110	755x465	850x500x855	38
V7228	Optional Divider for Parts Bins (available separately to parts bin)					

You May Also Like



See page 61



See pages 16-17



See page 60



## Mobile Panel Cart with Storage Cabinet

- The Panel Cart is used for transporting and storing a range of products
- The Mobile Panel Cart features 3 storage shelves as well as a large base which provides easy storage & accessibility for a range of products
- Pegboard Size (WxH): 850x300mm
- Louvre and pegboard panels are compatible with our Stor-Pak and pegboard accessories
- Storage cabinet supplied with a lock
- Powder coated dark grey finish
- Rubber castors - 2 x swive & 2 x swivel with brakes



Code	Castors (mm)	Shelf Capacity (kg)	Shelf Size (mm)	Cupboard Internal Size WxDxH (mm)	Overall Size LxWxH (mm)	Unit Weight (kg)
V7275	125	50	870x150	865x220x430	1025x670x1420	65

**You  
May  
Also  
Like**



**Wheel Chock Trolley**  
See page 303





## Louvre & Pegboard Panel Trolleys

- Strong metal panel trolleys which are ideal for storing either Stor-Pak Bins or tools on hooks
- Fitted with 4 swivel castors (2 with brakes)
- Powder coated grey colour
- Can be ordered one side with louvre panel and one side with square hole metal pegboard with code V7270
- Wheels can be removed to make fixed shelving if required
- Stor-Pak Bins and panel hooks are sold separately



**V7260K - Louvre Panel Trolley Kit**  
(with Stor-Pak Bins as listed below)

- 16 x No. 5 Stor-Pak Bins (Blue)
- 16 x No. 5 Stor-Pak Bins (Yellow)
- 16 x No. 10 Stor-Pak Bins (Red)
- 16 x No. 10 Stor-Pak Bins (Green)
- 12 x No. 25 Stor-Pak Bins (Yellow)
- 8 x No. 60 Stor-Pak Bins (Blue)
- 8 x No. 60 Stor-Pak Bins (Red)
- 4 x No. 120 Stor-Pak Bins (Green)

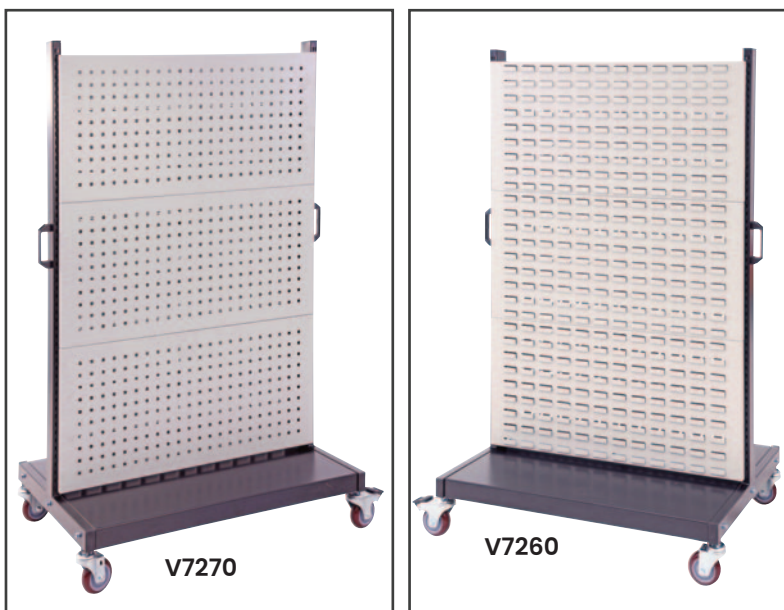

**V7270**

**V7260**



**V7265 - Shelf to suit panel trolley**

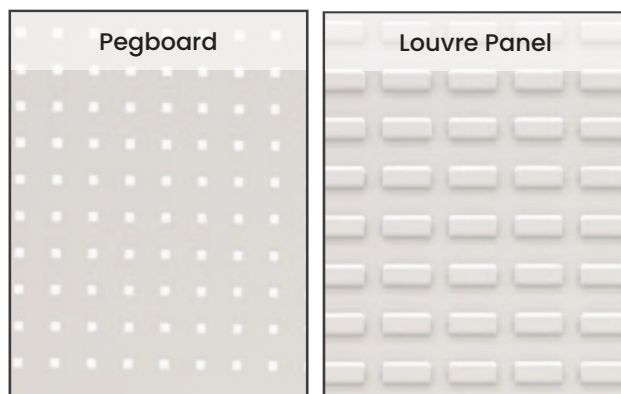

**Pegboard**

**Louvre Panel**

Code	Details	Overall Size LxWxH (mm)	Unit Weight (kg)
V7260	Louvre Panel Trolley	1040x980x1540	60
V7270	Panel Trolley (1 side pegboard & 1 side louvre panel)	1040x980x1540	60
V7262	Square Pegboard Panel Trolley	1040x980x1540	60
V7260K	Louvre Panel Trolley Kit*	1040x980x1540	85
V7265	Shelf to suit Panel Trolley	940x220	3

\*With Stor-Pak Bins exactly as pictured above



## Industrial Tooling Workstation

- Heavy duty tooling cabinets for industrial workshop applications
- The sliding drawers have quality smooth operation bearings
- Lockable cupboard with adjustable shelf
- Finish: Powder coated light grey and blue
- 2 fixed castors and 2 swivel lockable castors
- Fixed metal pegboard panel which suits our range of hooks and accessories
- Rubber mat on workbench area
- 5 lockable drawers with dividers (3 x 100mm and 2 x 200mm drawers)
- Bench Height: 950mm



Pictured with V7207 & V7208



Code	Details	Individual Drawer Capacity (kg)	Overall Capacity (kg)	Overall Size LxWxH (mm)	Unit Weight (kg)
V7230	Industrial Tooling Workstation	100	500	1100x580x1450	115
V7206	Extra Divider to suit 100mm Drawers				
V7207	Extra Divider to suit 200mm Drawers				

## Industrial Cabinet with 2 Drawers

- Storage cabinet is ideal for workshop and industrial applications
- Pegboard, drawer and cupboard storage spaces guarantee various sized tools and equipment can be stored efficiently
- Metal pegboard to neatly arrange tools and equipment for easy access
- Sliding drawers with smooth operation bearings allow smaller parts to be organised. Drawers also have adjustable dividers.
- 2 door lockable cabinet with 1 adjustable shelf
- Pegboard Size: 870x500mm



Rubber mat

2 x 75mm high lockable drawers



Adjustable shelves

Lockable cabinet

Code	Load Capacity (kg)	Shelf Capacity (kg)	Drawer Capacity (kg)	Bench Height (mm)	Bench Size (mm)	Overall Size WxDxH (mm)	Unit Weight (kg)
V7211	600	100	75	1010	875x555	900x585x1515	97.5





## 7 Drawer Industrial Tooling Cabinet

- The sliding drawers are a welded strengthened single rail design coupled with high quality mechanical bearings for long lasting smooth operation
- Each drawer has a mechanical safety lock which allows one drawer to be opened at a time
- All drawers come with adjustable steel dividers
- Drawer 1 to 6 - 150mm high
- Drawer 7 - 200mm high
- Internal Size (WxDxH): 777x451x122 (Drawers 1-6)
- Internal Size (WxDxH): 777x451x122 (Drawer 7)



Pictured with V7207 &amp; V7208

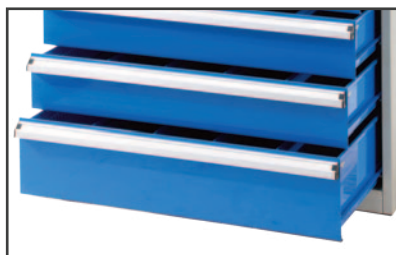

Code	Details	Individual Drawer Capacity (kg)	Overall Size WxDxH (mm)	Unit Weight (kg)
V7220	7 Drawer Industrial Tooling Cabinet	100	881x653x1200	121
V7207	Extra Divider to suit 200mm Drawers			
V7208	Extra Divider to suit 150mm Drawers			

## 10 Drawer Industrial Tooling Cabinet

- Heavy duty tooling cabinets for industrial applications
- The sliding drawers are a welded strengthened single rail design coupled with high quality mechanical bearings for long lasting smooth operation
- Single key lock design for safe storage.
- Each drawer has a mechanical safety lock which allows one drawer to be opened at a time, preventing the cabinet from tipping over
- All drawers come with adjustable steel dividers
- Drawer 1 to 9 - 100mm high
- Drawer 10 - 200mm high



Pictured with V7207 &amp; V7208



Code	Details	Individual Drawer Capacity (kg)	Overall Size WxDxH (mm)	Unit Weight (kg)
V7221	10 Drawer Industrial Tooling Cabinet	100	881x653x1200	160
V7206	Extra Divider to suit 100mm Drawers			
V7207	Extra Divider to suit 200mm Drawers			



# Heavy Duty Industrial Storage Cabinets

- These heavy duty industrial storage cabinets are made from reinforced sheet metal and are great for storing tools, parts and many other items in the workplace
- Full height cabinets come standard with 4 adjustable shelves and 1/2 height cabinet comes standard with 2 adjustable shelves – extra shelves can be purchased if required
- Optional drawer units can be purchased in either 100mm or 200mm deep
- Drawers come standard with 15 compartments (4 slotted partitions & 10 dividers)
- Total Cabinet Load Capacity: 600kg
- Shelf Capacity: 100kg
- Finish: Powder coated light grey with light blue coloured doors/drawers
- V7205 Cabinet Base Stand is ideal for levelling the cabinets on uneven floors (suits V7201 only)



## 1/2 Height Cabinet

- Shelf Capacity: 100kgs
- 3 point key lock system
- 2 adjustable shelves as standard
- Option drawer units available which fit inside unit so doors can be locked

**Code: V7200**



**V7209 Divider**  
to suit V7200  
& V7201 1/2 &  
Full Height  
Cabinets



**Code: V7205**  
Cabinet base stand available to suit V7201



## Full Height Cabinet

- Shelf Capacity: 100kgs
- 3 point key lock system
- 4 adjustable shelves as standard
- Optional drawer units available which fit inside unit so doors can be locked

**Code: V7201**







Optional drawer units available



Doors can be removed if preferred



100mm drawer

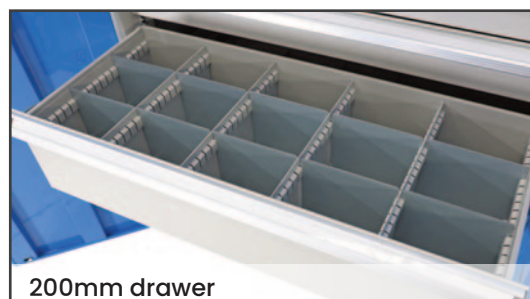

200mm drawer

Code	Details	Capacity (kg)	Overall Size WxDxH (mm)	Unit Weight (kg)
V7200	1/2 Height Industrial Cabinet	100 per shelf	900x450x900	45
V7201	Full Height Industrial Cabinet	100 per shelf	900x450x1800	85
V7202	Small Drawer Unit (to suit cabinets)	50 per drawer	100mm deep	8
V7203	Large Drawer Unit (to suit cabinets)	75 per drawer	200mm deep	15
V7204	Extra Shelves to suit Cabinets	150	840x380x30	5
V7205	Cabinet Base Stand (suits V7201) raises cabinet 70mm			4
V7206	100mm Divider to suit V7202 & V7203 (Pack of 10)	-	-	-
V7207	200mm Divider to suit V7202 & V7203 (Pack of 10)	-	-	-
V7209	Divider to suit V7200 & V7201	-	385x60x330	1.5

## Industrial Tooling Drawer Unit

- These industrial tooling drawers are a heavy duty drawer cabinet for industrial applications
- The 1/2 height industrial cabinet can be mounted on top of the tooling cabinet (as per image shown below)
- Finish: Powder coated light grey with light blue coloured drawers
- 2 x 100mm deep drawers
- 3 x 200mm deep drawers
- Drawers have adjustable dividers



V7210 - Drawer Unit

Pictured is the V7210 on the bottom with V7200 mounted on top



Code	Drawer Capacity (kg)	Overall Size WxDxH (mm)	Unit Weight (kg)
V7210	75	900x450x900	99



# Heavy Duty Industrial Storage Cabinets Complete With Drawers

- These heavy duty industrial storage cabinets are made from reinforced sheet metal and are great for storing tools, parts and many other items in the workplace
- Finish: Powder coated light grey with light blue coloured doors
- Supplied with 4 adjustable shelves
- Drawers come standard with 15 compartments (4 slotted partitions & 10 dividers)
- Overall Size (HxWxD): 1800x900x450mm
- Total Cabinet Load Capacity: 600kg
- 100mm Drawer Capacity: 50kg
- 200mm Drawer Capacity: 75kg
- Shelf Capacity: 100kg

### V8150 - 2 Drawer Cabinet

- 1 x 100mm drawer & 1 x 200mm drawer

### V8151 - 4 Drawer Cabinet

- 2 x 100mm drawers & 2 x 200mm drawers

### V8152 - 6 Drawer Cabinet

- 3 x 100mm drawers & 3 x 200mm drawers

### V8160 - 8 Drawer Cabinet

- 8 x 100mm drawers

### V8162 - 10 Drawer Cabinet

- 10 x 100mm drawers

### V8170 - 7 Drawer Cabinet

- 2 x 100mm drawers & 5 x 200mm drawers

### V8171 - 6 Drawer Cabinet

- 5 x 100mm drawers & 1 x 200mm drawer

### V8172 - 8 Drawer Cabinet

- 5 x 100mm drawers & 3 x 200mm drawers

### V8175 - 5 Drawer Cabinet

- 5 x 200mm drawers



100mm drawer



200mm drawer



Doors can be removed if preferred

Code	Details	Unit Weight (kg)
V8150	2 Drawer Cabinet ( 1 x 100mm & 1 x 200mm drawers)	108
V8151	4 Drawer Cabinet ( 2 x 100mm & 2 x 200mm drawers)	131
V8152	6 Drawer Cabinet ( 3 x 100mm & 3 x 200mm drawers)	154
V8160	8 Drawer Cabinet ( 8 x 100mm drawers)	149
V8162	10 Drawer Cabinet ( 10 x 100mm drawers)	165
V8170	7 Drawer Cabinet ( 2 x 100mm & 5 x 200mm drawers)	176
V8171	6 Drawer Cabinet ( 5 x 100mm & 1 x 200mm drawers)	140
V8172	8 Drawer Cabinet ( 5 x 100mm & 3 x 200mm drawers)	170
V8175	5 Drawer Cabinet ( 5 x 200mm drawers)	160







**V8150**  
(1 x 100mm & 1 x 200mm drawers)



**V8151**  
(2 x 100mm & 2 x 200mm drawers)



**V8152**  
(3 x 100mm & 3 x 200mm drawers)



**V8160**  
(8 x 100mm drawers)



**V8162**  
(10 x 100mm drawers)



**V8170**  
(2 x 100mm & 5 x 200mm drawers)



**V8171**  
(5 x 100mm & 1 x 200mm drawers)



**V8172**  
(5 x 100mm & 3 x 200mm drawers)



**V8175**  
(5 x 200mm drawers)



## Industrial & Cleanroom Seating

- This seating is designed to withstand hard use, moisture and chemicals in the industrial environment
- Ideal for workplace environments such as factory production lines, clean rooms, workshops and laboratories
- Easy clean polyurethane or industrial vinyl seats and backrests
- Easy clean polyurethane or industrial vinyl seats and backrests
- Chairs are available with glide feet or standard castors
- Load Capacity: 110kg



C1200



C1201



C1202



C1203



C1204

Code	Details	Height Adjustment (mm)	Unit Weight (kg)
C1200C	Polyurethane Saddle Seat (with Castors)	420 - 520	10
C1200G	Polyurethane Saddle Seat (with Glides)	420 - 620	10
C1201C	Polyurethane Stool - foot rest surround (with Castors)	590 - 840	10
C1201G	Polyurethane Stool - foot rest surround (with Glides)	590 - 840	10
C1202C	Polyurethane Chair (with Castors)	460 - 660	10
C1202G	Polyurethane Chair (with Glides)	460 - 660	10
C1203C	Polyurethane Round Seat - foot rest surround (with Castors)	590 - 840	10
C1203G	Polyurethane Round Seat - foot rest surround (with Glides)	590 - 840	10
C1204C	Polyurethane Round Seat (with Castors)	420 - 520	10
C1204G	Polyurethane Round Seat (with Glides)	420 - 520	10





## Ergo Tred Anti-Fatigue Matting

Ergo Tred is a hardwearing, comfortable, non-slip anti-fatigue mat. It is used in dry, demanding work areas such as at checkouts, counters, machines, workbenches and workstations.

- Extremely comfortable – provides relief from constant standing
- Domed surface is ergonomically designed to improve circulation in feet and legs
- Hard wearing – long mat life even in demanding conditions
- Yellow border option – makes mat edges stand out to warn user of hazard
- HACCP Certified for use in dry areas

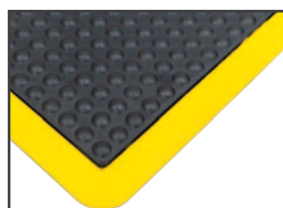

Black with Yellow border

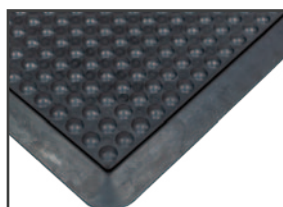

Black with Black border



Code	Details	Colour	Overall Size (mm)
V7730	Ergo Tred Rubber Anti-Fatigue Mat	Black	600x900
V7731	Ergo Tred Rubber Anti-Fatigue Mat	Black & Yellow	600x900
V7732	Ergo Tred Rubber Anti-Fatigue Mat	Black	900x1200
V7733	Ergo Tred Rubber Anti-Fatigue Mat	Black & Yellow	900x1200

## Anti-fatigue Safety Cushion Matting

- Popular general purpose safety mat
- Comfort non-slip mat
- Bevelled edges for safety
- Optional grease resistant formula
- Ideal for factories, kitchens, food preparation areas, boats and behind counters

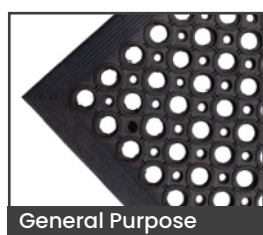

General Purpose



Grease Resistant

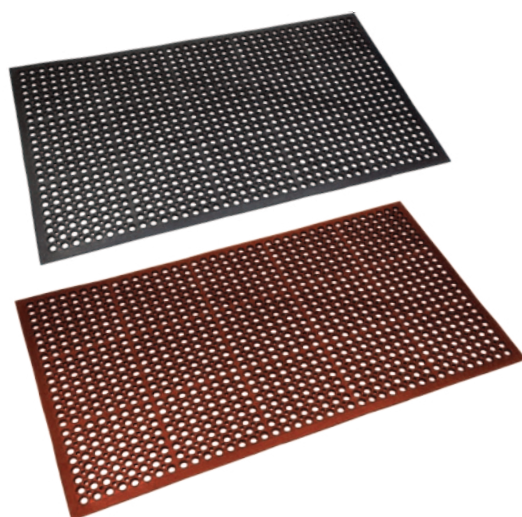

Code	Details	Type	Overall Size (mm)	Unit Weight (kg)
V7720	Anti-fatigue Safety Cushion Mat	General Purpose	600x900mm	6
V7721	Anti-fatigue Safety Cushion Mat	General Purpose	900x1500mm	10
V7722	Anti-fatigue Safety Cushion Mat	Grease Resistant	600x900mm	6
V7723	Anti-fatigue Safety Cushion Mat	Grease Resistant	900x1500mm	10



## Heavy Duty Warehouse Packing Bench

- Strong heavy duty work or packing bench
- 25mm MDF bench top and shelf
- Bench is supplied flat packed
- Image shown with optional bottom shelf
- Castor Kit raises bench height by 140mm
- Top and bottom shelves are height adjustable
- Bench Size: 2390x860x25mm



Image shown with optional bottom shelf level and castor kit



Timber shelf is chamfered to remove sharp edge



Watch a video of this in operation on our website here: [www.verdex.com.au/v7320](http://www.verdex.com.au/v7320)



Code	Details	Load Capacity(kg)	Overall Size LxWxH (mm)	Unit Weight (kg)
V7320	Heavy Duty Packing Bench	500	2525x900x1000	74
V7321	Optional Bottom Shelf	-	2390x860x25	36
V7326	100mm Lockable Castor Kit to suit Packing Bench			8

## Heavy Duty Industrial Workbenches 900 Series

- Heavy duty steel industrial workbench is ideal for use as a work or tool bench
- This workbench has a 600kg top bench capacity
- 28mm thick laminated wooden top
- Comes standard with adjustable feet for levelling on uneven floors
- Finish: Powder coated light grey



V7246 Lockable Castor Kit



V7300 - Workbench



Dividers supplied with drawer unit



Code	Details	Dimensions LxWxH (mm)	Unit Weight (kg)
V7300	Industrial Workbench	900x750x800	35
V7310	Lockable Drawer Unit 410x680x180mm (WxDxH)	410x680x180	12
V7246	Castor Kit to suit V7300 Workbench		







# Heavy Duty Industrial Workbenches 1200 Series

- Heavy duty steel industrial workbench with bottom shelf is ideal for use as a work or tool bench
- 1000kg wood top bench capacity
- 53mm thick laminated wooden top
- Comes standard with adjustable feet for levelling on uneven floors and an optional lockable castor kit is available if required
- Drawer Unit Capacity: 100kg per drawer
- Finish: Powder coated light grey



**V7246**  
Lockable Castor Kit

## Shelf Options

**V7253 - 2 Tier Shelf**



**V7250 - Adjustable Shelf**



## Drawer & Cabinet Options

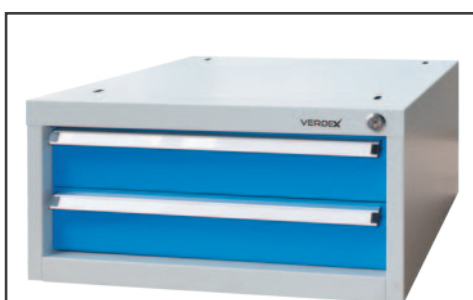

**V7244 - 2 Drawer Unit**  
2 x 100mm drawers



**V7312 - 3 Drawer Unit**  
2 x 100mm, 1 x 200mm drawers



**V7315 - Cabinet Unit**

Code	Details	Dimensions (mm)	Unit Weight (kg)
V7305	Industrial Workbench	1200x750x900 (LxWxH)	66
V7312	Lockable Drawer Unit (3 drawer)	565x650x450mm (WxDxH)	45
V7315	Lockable Cabinet Unit (with shelf)	565x650x450mm (WxDxH)	14
V7250	Adjustable Shelf to suit V7305	1200x285mm (LxD)	9
V7253	2 Tier Shelf Unit to suit V7305	1200x250mm (LxD)	13
V7244	Lockable Drawer Unit (2 drawer)	565x650x280mm (WxDxH)	25.5
V7246	Workbench Castor Kit (includes 4 swivel castors with brakes)		

# Heavy Duty Industrial Work Benches 1800/2100 Series

- Heavy duty steel industrial workbenches which are ideal for use as a work or tool benches
- 1000kg wood top bench capacity
- 40mm thick laminated wooden top (V7240, V7242)
- 53mm thick laminated wooden top (V7306, V7307)
- Comes standard with adjustable feet for levelling on uneven floors and an optional lockable castor kit is available if required
- Bottom shelf benches available in both 1800 and 2100mm sizes
- Drawer Unit Capacity: 100kg per drawer
- Finish: Powder coated light grey



## Shelf Options

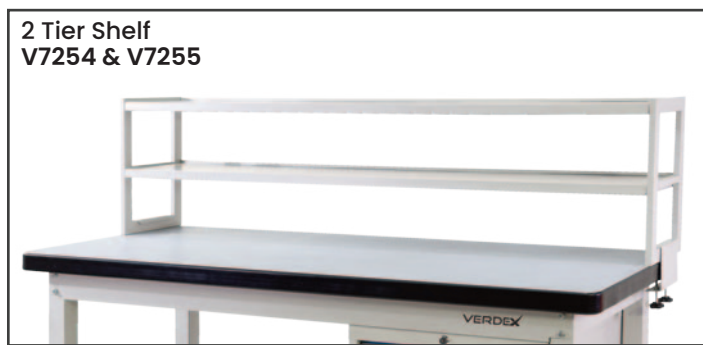
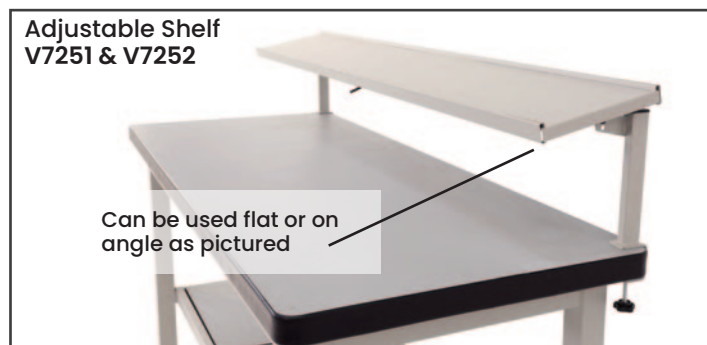

## Accessory Options







## Drawer &amp; Cabinet Options



**V7244 - 2 Drawer Unit**  
2 x 100mm drawers



**V7312 - 3 Drawer Unit**  
2 x 100mm, 1 x 200mm drawers



**V7315 - Cabinet Unit**



**V7245 - 6 Drawer Unit**  
2 x 75mm, 2 x 150mm,  
2 x 200mm drawers



Dividers supplied  
with all drawer units



Code	Details	Dimensions (mm)	Unit Weight (kg)
V7240	Industrial Workbench 1800mm	1800x750x900 (LxWxH)	66.5
V7242	Industrial Workbench 2100mm	2100x750x900 (LxWxH)	76.5
V7306	Industrial Workbench 1800mm (with bottom shelf)	1800x750x900 (LxWxH)	99
V7307	Industrial Workbench 2100mm (with bottom shelf)	2100x750x900 (LxWxH)	109

## Shelf Options

V7251	Adjustable Shelf to suit 1800mm bench	1800x250 (LxD)	11
V7252	Adjustable Shelf to suit 2100mm bench	2100x250 (LxD)	12
V7254	2 Tier Shelf Unit to suit 1800mm bench	1800x285 (LxD)	20
V7255	2 Tier Shelf Unit to suit 2100mm bench	2100x285 (LxD)	23
V7241	Back Panel Kit to suit 1800mm bench	1800x750x900 (LxWxH)	34
V7243	Back Panel Kit to suit 2100mm bench	21035x205x825 (LxWxH)	39

## Underbench Options

V7244	Lockable Drawer Unit (2 drawer)	565x650x280mm (WxDxH)	25.5
V7312	Lockable Drawer Unit (3 drawer)	565x650x450mm (WxDxH)	45.5
V7245	Lockable Drawer Unit (6 drawer)*	565x580x750mm (WxDxH)	85
V7315	Lockable Cabinet Unit (with shelf)	565x650x450mm (WxDxH)	14
V7246	Workbench Castor Kit (includes 4 swivel castors with brakes)		

\*Please Note: The V7245 (6 drawer unit) won't fit under the workbenches with bottom shelves

## Modular Ergonomic Packing Workbenches

- Our 2400mm Heavy Duty Modular Ergonomic Workbench comes with height adjustable legs for all your requirements or applications.
- It can be configured with a large range of accessories to maximise efficiency in your workspace.
- These benches are ideal for packing, industrial processes, workshops and multiple other applications. *Configure your bench today!*
- 37mm thick bench top, material is particle board with a PVC top & a high pressure, laminate underside
- 500kg capacity
- Comes standard with adjustable feet for levelling on uneven floors
- Finish: Powder coated light grey
- Bench Height: 737 to 1037mm – can adjust at 50mm increments



SCAN to *view* our full range of Modular Ergonomic Workbenches

Visit [verdex.com.au/industrial-workplace-equipment/modular-workbenches/](http://www.verdex.com.au/industrial-workplace-equipment/modular-workbenches/) to view our full range of workbenches & accessories to create your own workspace





## Accessories to suit Workbenches

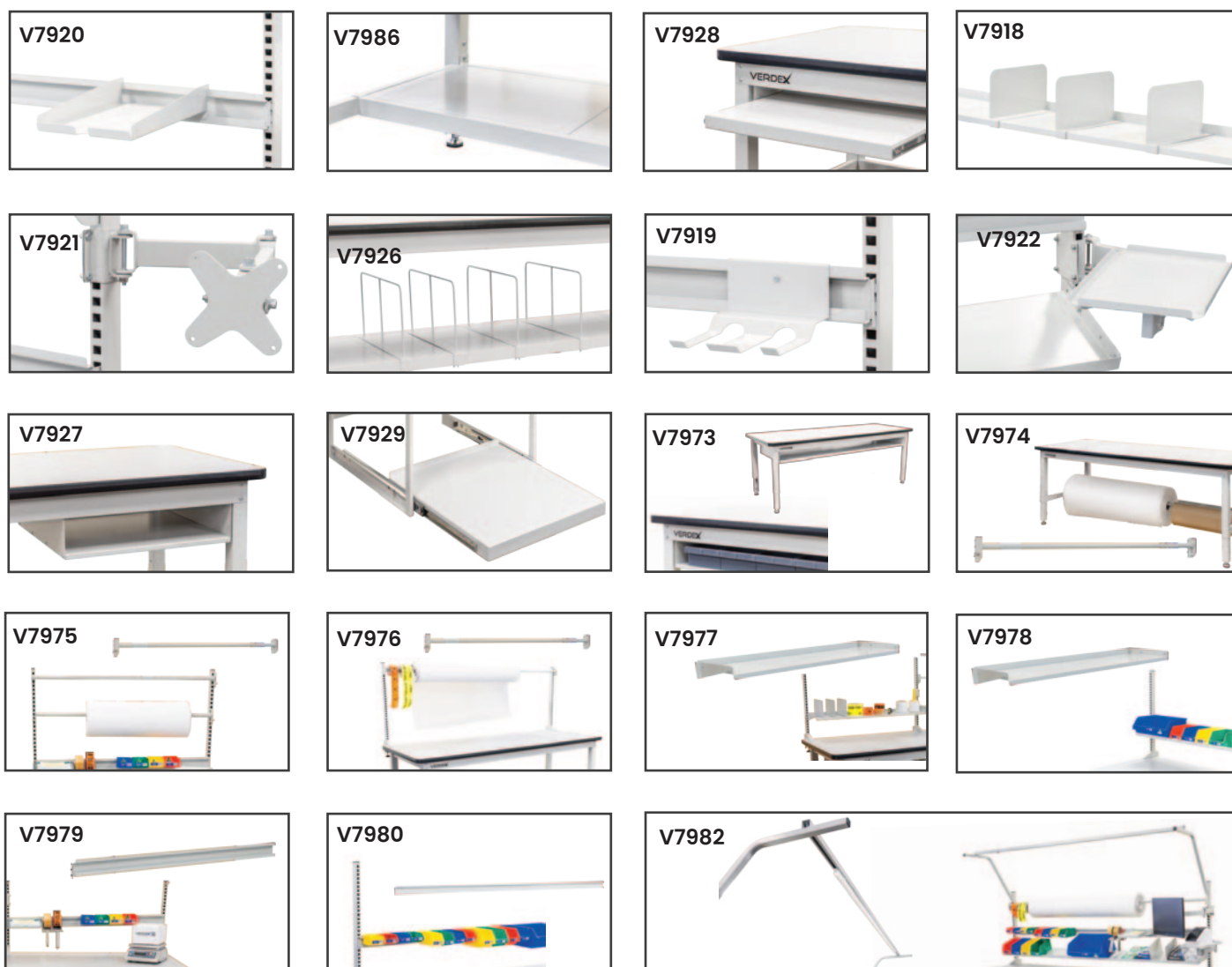

Code	Accessories to suit
V7918	Back Panel Shelf Divider
V7919	Back Panel Tape Dispenser Holder
V7920	Back Panel A4 Document Holder
V7921	Back Panel Monitor Arm
V7922	Back Panel Label Printer Arm
V7926	Under Shelf Divider (300mm high)
V7927	Under Shelf Tool Holder
V7928	Under Shelf Slide Out Keyboard Shelf
V7929	Under Shelf Slide Out CPU/Printer Shelf
V7986	Under Shelf Kit

Code	Full Length Accessories
V7973	Underbench Tool Shelf Unit
V7974	Underbench Roll Holder
V7976	Back Panel Roll Holder
V7978	Back Panel Reversible/Tilting Shelf
V7980	Back Panel Bin Rail
V7982	Back Panel Light & Balancer Rail

Code	Half Length Accessories
V7975	Back Panel Roll Holder
V7977	Back Panel Reversible/Tilting Shelf
V7979	Back Panel Bin Rail

# CUSTOM CONFIGURATIONS OF ERGONOMIC PACKING BENCHES



*Visit our website to create your ideal workspace*







# BUILD YOUR OWN WORKBENCH USING OUR ONLINE CONFIGURATOR

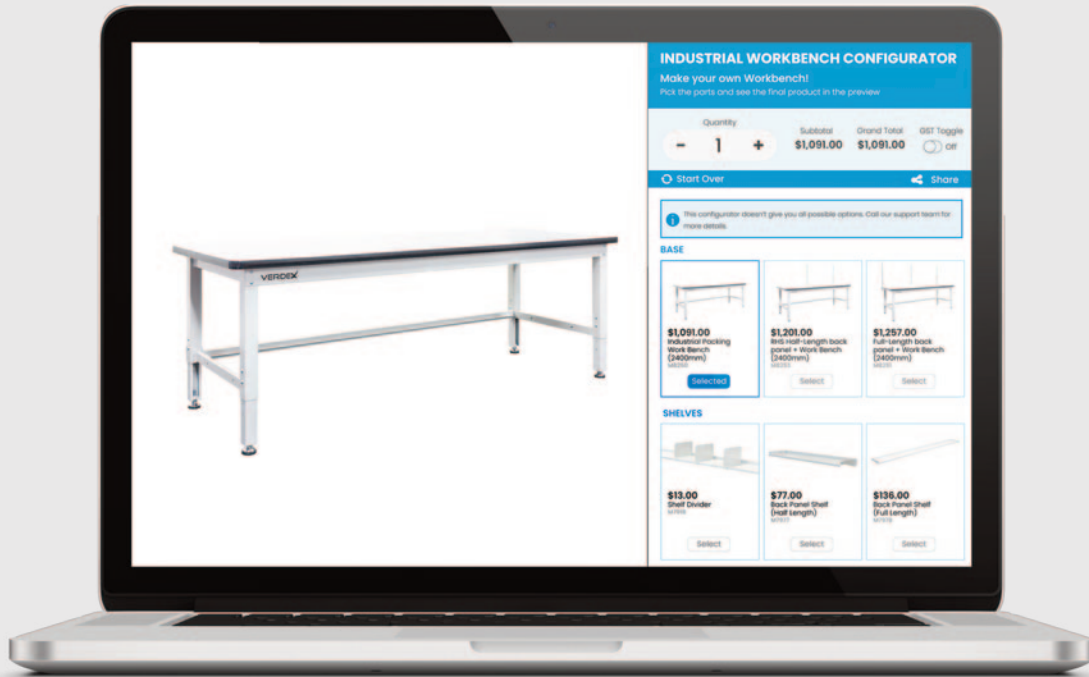

Scan here for our online Configurator Page

[www.verdex.com.au/workbench-configurator](http://www.verdex.com.au/workbench-configurator)

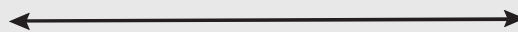
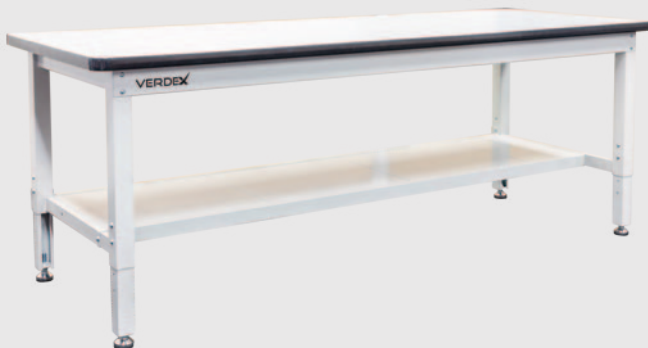

MODULAR WORKBENCH  
**Before & After**  
Initial - Full Kit Configuration

## Stainless Steel Benches

- Ideal for hospitality, pharmaceutical and medical
- 1.2mm thick 304 grade stainless steel top & undershelf
- 201 grade stainless steel legs
- Easy to wipe clean and keep hygienic
- Six widths available from 900mm to 2400mm
- Bench Depth: 600mm
- Bench Height: 900mm
- Supplied flat packed ready for assembly

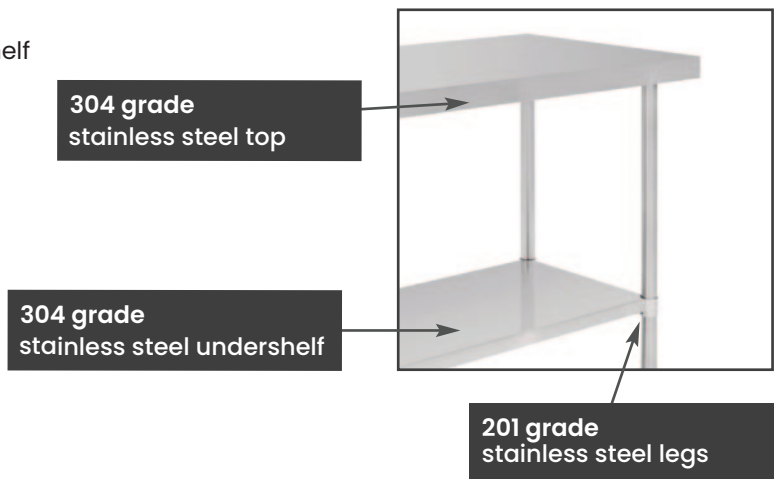

Code	Details
V8200	Stainless Steel Bench 900x600x900mm (WxDxH)
V8201	Stainless Steel Bench 1200x600x900mm (WxDxH)
V8202	Stainless Steel Bench 1500x600x900mm (WxDxH)
V8203	Stainless Steel Bench 1800x600x900mm (WxDxH)
V8205	Stainless Steel Bench 2400x600x900mm (WxDxH)





## Stainless Steel Benches (With Splashback)

- 1.2mm thick 304 grade stainless steel top and undershelf
- 201 grade stainless steel legs
- 100mm splashback to stop items falling down back of bench
- Easy to wipe clean and keep hygienic
- Seven widths available from 600mm to 2400mm
- Bench Height with Splashback: 1000mm



Code	Details
V8220	Stainless Steel Bench with splashback 600x600x900mm (WxDxH)
V8221	Stainless Steel Bench with splashback 900x600x900mm (WxDxH)
V8222	Stainless Steel Bench with splashback 1200x600x900mm (WxDxH)
V8223	Stainless Steel Bench with splashback 1500x600x900mm (WxDxH)
V8224	Stainless Steel Bench with splashback 1800x600x900mm (WxDxH)
V8225	Stainless Steel Bench with splashback 2100x600x900mm (WxDxH)
V8226	Stainless Steel Bench with splashback 2400x600x900mm (WxDxH)

## Stationery Cabinets

- Versatile, functional & practical steel office furniture allows freedom to create & configure storage solutions to suit your individual requirements.
- Supplied fully assembled
- All Cupboards are Key lockable
- Available in 1/2 Height and Full Height Sizes
- Full height cabinet comes standard with 3 shelves and 1/2 height cabinet comes standard with 1 shelf (extra shelves available)
- Shelf Thickness: 25mm
- Shelf Capacity: 40kg
- Extra Shelves are supplied with clips



V7072 - Optional Extra Shelves

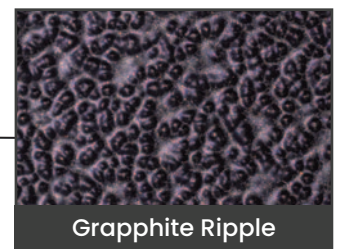
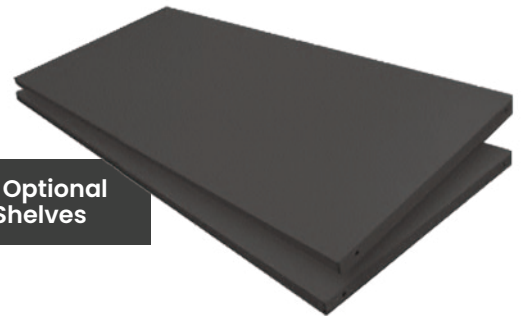

Grapphite Ripple

V7070

V7071

Code	Details	Overall Dimensions HxWxD (mm)	Unit Weight (kg)
V7070	Half Height Stationery Cabinet (Dark Grey)	1015x910x450	28
V7071	Full Height Stationery Cabinet (Dark Grey)	1830x910x450	44
V7072	Extra Shelf to suit V7070 & V7071	900x390	-





## 5 Tier Shelving Unit with Adjustable Feet

- This unit is used for displaying or storing food products and can also be used in warehouses, retail stores, offices etc.
- Includes five shelves
- Adjustable feet
- Overall Capacity: 400kg
- Shelf Capacity: 120kg
- Tray Size (LxW): 915x520mm

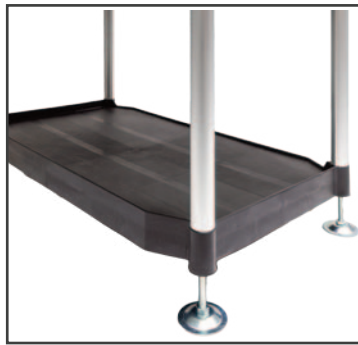

Code	Overall Size LxWxH (mm)	Tray Size (mm)	Unit Weight (kg)
V7090	920x520x1800	915x520	24

## CHECK OUT THE 3 TIER UTILITY CART



See page 41

## Open Steel Shelving Unit

- This Open steel shelving Unit is roll formed from durable premium pre-painted steel
- Designed for office and warehouse applications
- Comes with 4 Shelves
- Optional shelves sold as a pair only, available (Can fit up to 14 shelves at 118 pitch)
- Powder coat Finish
- Max. Capacity: 250kg
- Shelf Capacity: 50kg

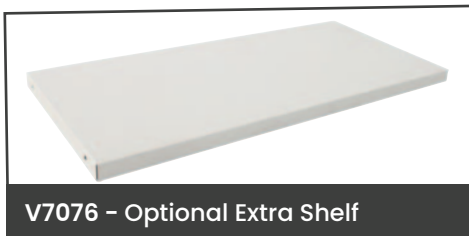

V7076 - Optional Extra Shelf



Code	Details	Overall Size LxWxH (mm)	Unit Weight (kg)
V7085	Open Steel Shelving Unit	890x455x2200	40
V7086	Open Steel Shelving Unit Extra Shelves	887x420x25	3.25

## Steel Shelving Parts Tray Kits

- This steel shelving is roll formed from premium pre-painted steel to ensure durability and engineering integrity for both office and warehouse storage applications.
- Colour: Silver Grey
- Supplied flat packed - Easy to assemble
- 100kg shelf load capacity
- Max Load Capacity Per Bay: 200kg
- Overall Size (LxwxH): 890x455x2200mm



**IH-017**  
Parts Trays  
Size LxWxH:  
400x100x100mm  
(with 3 dividers)



**IH-025**  
Parts Trays  
Size LxWxH:  
400x200x100mm  
(with 3 dividers)



V7082



V7083



V7084

Code	Details	Unit Weight (kg)
V7082	Shelf Unit Kit (includes 120 x IH-017 parts trays)	118
V7083	Shelf Unit Kit (includes 60 x IH-025 parts trays)	95
V7084	Shelf Unit Kit (includes 48 x IH-017 & 32 x IH-025 parts trays)	105



## Heavy Duty Parts Cabinet (30 Parts Trays)

- These Heavy Duty Parts Cabinets are a great way to store parts neatly and efficiently
- Parts Trays have a transparent front window to easily view product inside
- Parts trays have a raised back lip
- Each bin comes with one divider and one bin label card
- Different color tags can be applied for easier identification
- External Plastic Parts Bin Size (LxWxH): 415x170x105mm
- Internal Plastic Parts Bin Size (LxWxH): 380x140x100mm



Code	Details	Parts Bin Capacity (kg)	Overall Size WxDxH (mm)	Unit Weight (kg)
V7350	Heavy Duty 30 Parts Cabinet	10	900x420x880	51
V7353	Optional Dividers to suit V7350 (available seperately to parts trays)			

## Heavy Duty Parts Cabinet (60 Parts Trays)

- These Heavy Duty Parts Cabinets are a great way to store parts neatly and efficiently
- Parts Trays have a transparent front window to easily view product inside.
- Parts trays have a raised back lip
- Each bin comes with one divider and one bin label card
- Different color tags can be applied for easier identification
- External Plastic Parts Bin Size (LxWxH): 415x170x105mm
- Internal Plastic Parts Bin Size (LxWxH): 380x140x100mm



Code	Details	Parts Bin Capacity (kg)	Overall Size WxDxH (mm)	Unit Weight (kg)
V7351	Heavy Duty 60 Parts Cabinet	10	900x420x1760	110
V7353	Optional Dividers to suit V7351 (available seperately to parts trays)			



# Palomat Greenline Pallet Dispenser

- No manual pallet handling - reduces back strain from manually lifting pallets
- Space saving and a tidy workplace
- Optimised pallet flow
- Improved work environment
- Fewer back injuries, jammed fingers, and feet
- Stainless steel version available if required
- Increased efficiency
- No of Pallets: 15
- Suits Australian Chep and Loscam sized pallets
- Noise Level: 70 dBa
- Power: 220-240VAC / 50 Hz
- Can be adjusted for cool-room environments down to -25°C
- Fully electric operation
- Warranty: 12 months
- Made in Denmark



Watch a video of this in operation on our website here: [www.verdex.com.au/V7745](http://www.verdex.com.au/V7745)



Suits Australian Chep & Loscam pallets



V7745 pictured without pallets



Control Panel

Code	Lifting Capacity (kg)	Overall Size WxDxH (mm)	Unit Weight (kg)
V7745	700	1705x1520x2350	420

# Semi-Auto Strapping Machine

- Power Supply: 240V
- Electric adjustment for strap length and tension
- PP Strapping Width: 5 - 15.5mm
- PP Strapping Thickness: 0.6-1.0mm
- Max Strapping Tension: 5-40kg
- Strapping Speed: 2.5 Seconds/Strap
- Table Height: 750mm



Code	Max Loading Weight (kg)	Machine Dimensions LxWxH (mm)	Unit Weight (kg)
V7760	180	785x545x750	60



Watch a video of this in operation on our website here: [www.verdex.com.au/V7760](http://www.verdex.com.au/V7760)





# Stretch Wrapping Machines

- Electronic screen with 'Soft Touch' control
- Variable film carriage and turntable speeds
- Photocell eye for automatic height detection
- Automatic and Manual wrapping programs
- Soft-start and stop turntable drive
- 250% Pre-Stretch film carriage
- Power supply: 240v, single phase
- Ramp can be positioned anywhere around the turntable
- Ramp Finish: Powercoated Blue
- Ramp Overall Size (WxLxH): 1000x1500x80mm
- Ramp Weight: 56kg
- Heavy-duty industrial chain driven turntable
- Forklift relocation slots for easy machine transportation
- Rugged steel construction for long-term reliability
- Standard 12 month warranty
- Load capacity: 1500kg
- Fork Pocket Size: 154x54mm
- Fork Pocket Centres: 570mm
- Max height of wrapping: 2100mm
- Max pallet size: 1200x1200mm
- Overall Machine Dimensions (LxWxH): 2455x730x2200mm
- Turntable diameter: 1500mm
- Turntable Height: 80mm
- Turntable speed: 1-12 RPM
- Stretch film size: 500mm (width)
- Maximum film roller diameter: 250mm
- Maximum film roller inner diameter: 76mm
- V7741 Unit Weight: 415kg
- V7742 Unit Weight: 435kg



V7741 Control Panel



V7742 Control Panel

V7742 pictured with V7743 (optional ramp to suit)

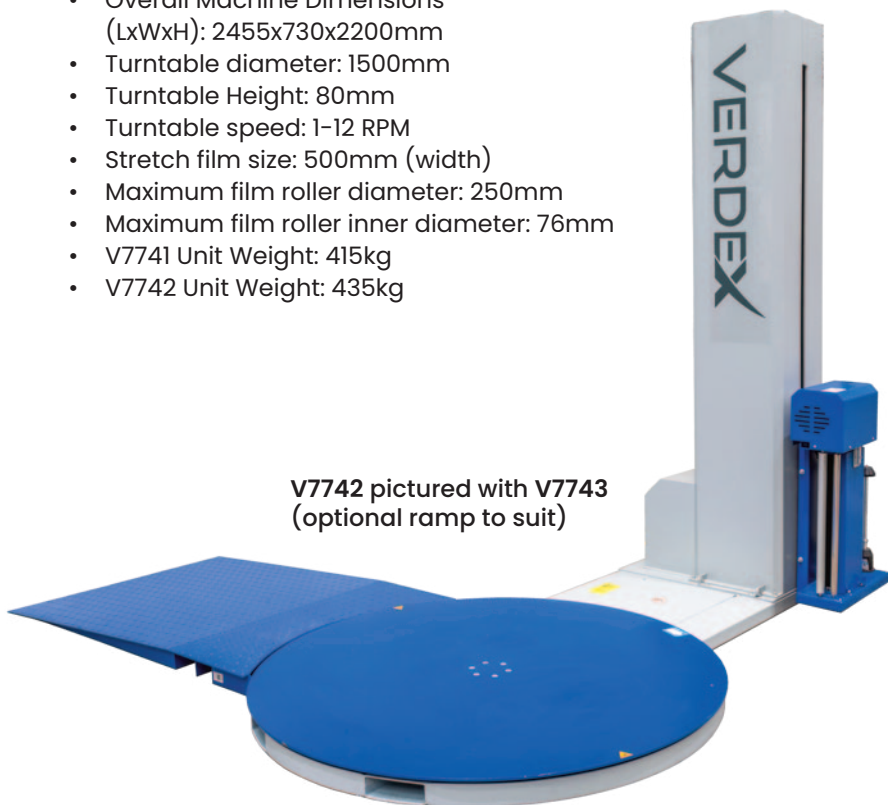

V7741



Watch a video of this in operation on our website here: [www.verdex.com.au/V7742](http://www.verdex.com.au/V7742)



Code	Details
V7741	Semi-Auto Stretch Wrapping Machine
V7742	Full-Auto Stretch Wrapping Machine
V7743	Optional Ramp to suit Wrapping Machines



## Shipping / Parcel Scales

- Low profile design
- Rigid construction
- Remote display unit for weighing ease
- Hold or net / gross function
- Unit conversion available (KG/LB/OZ)
- Large and bright easy-to-read LCD display
- Auto-off function for power saving in seconds (120, 180, 240, 360, off optional)
- Rechargeable Battery and AC adaptor supplied
- Function Keys: Zero, Tare, Hold, Unit, On/Off

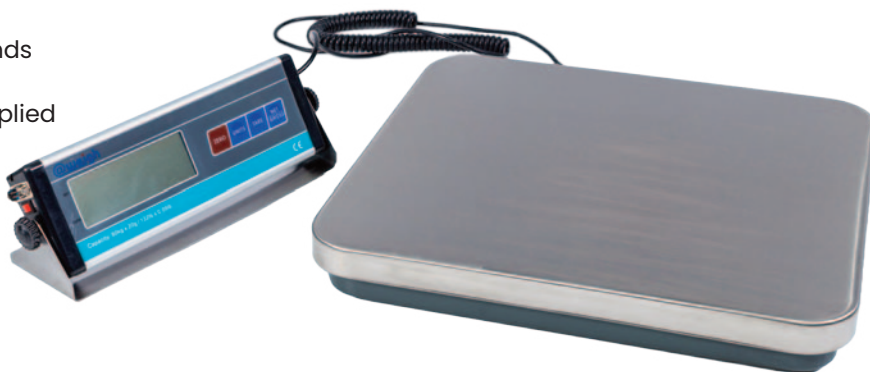

Remote Display Unit

Code	Details	Load Capacity (kg)	Platform Size (mm)	Unit Weight (kg)
V7703	Parcel Scale (10g increments)	30	310x310	5
V7706	Parcel Scale (20g increments)	60	405x355	6

## Floor Pallet Scales

- Great for weighing pallets and large bulky and heavy items
- Adjustable levelling feet for uneven ground
- Can be pit mounted so that it sits flush with the ground
- Low Profile 70mm height from ground level
- Construction: Mild Steel
- Power Supply: 240 V
- Increments: 500g



Code	Details	Load Capacity (kg)	Platform Size LxWxH (mm)	Unit Weight (kg)
V7700	2000kg Capacity Floor Pallet Scales	2000	1200x1200x70	75
V7701	3000kg Capacity Floor Pallet Scales	3000	1200x1200x70	75





## Pedestal Industrial Fan

Quality robust construction designed for everyday use in industrial workshops or warehouses.

- Includes optional Wall Mount Bracket
- Powder Coated Steel Frame
- Oscillating function
- Motor: 240v, 3 Speed
- Blade Diameter: 750mm

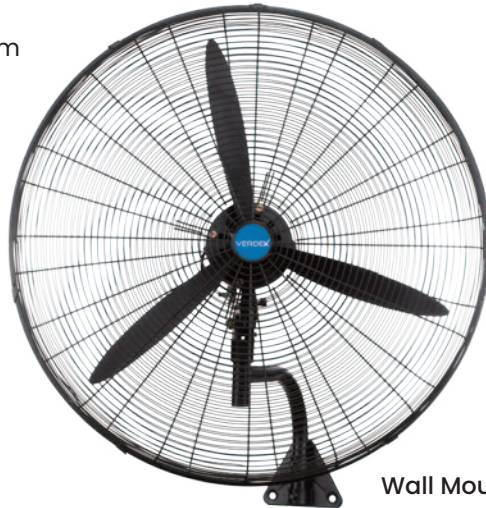

Wall Mount option



Height fully extended

Code	Lowered Height (mm)	Extended Height (mm)	Overall Size LxWxH (mm)	Unit Weight (kg)
V6432	1550	1880	1880x750x600	18.3

## Industrial Mobile Fan

- Plastic construction
- Maximum Speed: 480r/min
- Voltage Frequency: 220-240V/50Hz
- Motor Power: 600W
- Motor Type: Permanent magnet motors with variable speeds
- Airflow: 42000m<sup>3</sup>/min



Code	Blade Diameter (mm)	Overall Size LxWxH (mm)	Unit Weight (kg)
V6434	1500	1570x760x1960	58

# Stor-Pak Parts Bins

- Strong polypropylene bins which are ideal for parts and products storage
- Sit on shelves, benches, stack them or clip them to louvre panels
- All Stor-Pak bins are stackable
- Available in green, blue, red, yellow and clear
- Optional dividers available for #60, #120 and #240 bins
- Hospital grade material - bacterial free and chemical free
- Bin colours available:



Green Blue Red Orange Yellow Clear



Optional dividers available for sizes 60, 120 & 240 bins



Size #5



Size #10



Size #25



Size #60



Size #80



Size #120



Size #240

Code	Details	Size WxDxH (mm)	Volume (L)	Ctn Qty	Unit Weight (kg)
IH-060	Stor-Pak Bin #5	100x115x60	0.5	12	0.05
IH-061	Stor-Pak Bin #10	100x170x85	1.0	6	0.09
IH-062	Stor-Pak Bin #25	133x220x125	2.5	6	0.2
IH-063	Stor-Pak Bin #60	200x275x165	6.0	6	0.5
IH-200	Stor-Pak Bin #80	200x440x165	8.0	6	0.6
IH-064	Stor-Pak Bin #120	410x275x165	12	5	0.8
IH-065	Stor-Pak Bin #240	410x440x210	24	4	1.3
<b>Dividers</b>					
IH-058	Stor-Pak Dividers (suits bins #60 and #120)			40	0.3
IH-057	Stor-Pak Dividers (suits bins #240)			45	0.1

\*Please specify colour when placing your order



# Spare Parts Trays

- Strong polypropylene oil resistant trays which are supplied with dividers
- Extra dividers are available to create more compartments in the trays
- Ideal for small parts storage
- Hospital grade material - bacterial free and chemical free



Size #12



Size #17



Size #27



Size #24



Size #25



Size #28



Size #30



Size #31



Size #32

Code	Details	Size LxWxH (mm)	Dividers Supplied	Ctn Qty
IH-012	Spare Parts Tray #12	300x100x100	2	24
IH-017	Spare Parts Tray #17	400x100x100	2	24
IH-027	Spare Parts Tray #27	600x100x100	5	12
IH-024	Spare Parts Tray #24	300x200x100	2	12
IH-025	Spare Parts Tray #25	400x200x100	2	12
IH-028	Spare Parts Tray #28	600x200x100	5	6
IH-230	Spare Parts Tray #30	300x300x100	2	8
IH-231	Spare Parts Tray #31	400x300x100	2	8
IH-232	Spare Parts Tray #32	600x300x100	5	4
<b>Dividers</b>				
IH-014	Spare Parts Dividers-100mm wide			12
IH-026	Spare Parts Dividers-200mm wide			12
IH-233	Spare Parts Dividers-300mm wide			12





# Mesh-Pak Storage Bins

- The ultimate practical storage system and part of the stor-pak range
- Available in three sizes to accommodate small as well as bulky items
- Produced in tough and durable hospital grade material - bacterial free and chemical free
- Angled front provides easy picking access
- Perforated bottom ensures no dust collects at the bottom of the box
- Dividers available for Stor-Pak #60 and #120
- Colours Available: Blue or Clear



Code	Details	Size WxDxH (mm)	Volume (L)	Ctn Qty	Unit Weight (kg)
IH-061MPB	Mesh-Pak Bin #10-Blue	100x170x85	1.0	6	0.09
IH-061MPC	Mesh-Pak Bin #10-Clear	100x170x85	1.0	6	0.09
IH-062MPB	Mesh-Pak Bin #25-Blue	133x220x125	2.5	6	0.2
IH-062MPC	Mesh-Pak Bin #25-Clear	133x220x125	2.5	6	0.2
IH-063MPB	Mesh-Pak Bin #60-Blue	200x275x165	6.0	6	0.5
IH-063MPC	Mesh-Pak Bin #60-Clear	200x275x165	6.0	6	0.5
IH-064MPB	Mesh-Pak Bin #120-Blue	410x275x165	12	5	0.8
IH-064MPC	Mesh-Pak Bin #120-Clear	410x275x165	12	5	0.8

### Dividers

IH-058	Dividers (to suit bins #60 & #120)			40	
--------	------------------------------------	--	--	----	--



# Visi-Pak Storage Bins

- Fully modular the Visi-Pak is supplied with special clips which enable them to fit onto a louvre panel - doors swivel forward for easy access
- They can also be screwed onto a wall or left free standing on a bench top
- Ideal for small parts storage
- Available in 3 standard sizes
- Hospital grade material - bacterial and chemical free

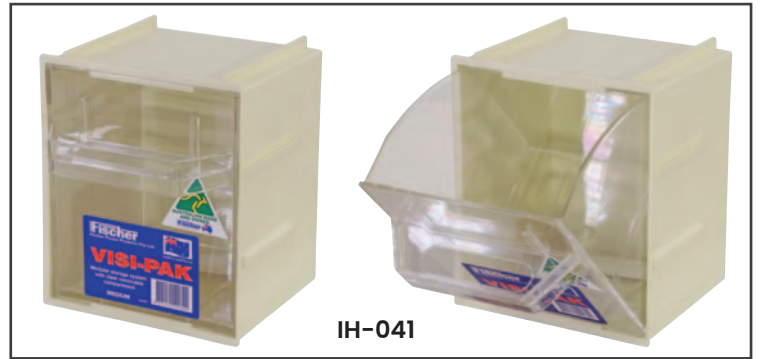

Code	Details	Size WxDxH (mm)	Volume (L)
IH-040	Visi-Pak - Small	103x83x120	0.25
IH-041	Visi-Pak - Medium	154x126x180	1.5
IH-042	Visi-Pak -Large	208x167x235	3.5





## Drawer Organisers

- Ideal for storing nuts, bolts, screws etc
- Can be mounted onto louvre panel or screwed directly onto a wall
- Blue with clear drawers
- Hospital grade material - bacterial free and chemical free
- Material: Durable Co-Polymer



Code	Details	Unit Size WxDxH (mm)	Drawer Size WxDxH (mm)
IH-048	Drawer Organiser (2 drawer)	87x136x98	70x125x40
IH-044	Drawer Organiser (3 drawer)	155x125x140	145x125x40
IH-050	Drawer Organiser (12 drawer)	230x128x188	70x125x40
IH-051	Drawer Organiser (20 drawer)	305x128x230	70x125x40

## Ezi-Pak Carry Case

- Tough carry cases for tools and accessories
- Made from ABS plastic with polycarbonate lids
- Comes with removable dividers (21 compartments)
- Removable dividers
- Available in Red and Blue
- Modular frame which is great for use in vehicles or can be mounted to a workbench and can have multiple modules stacked on top of each other
- Modular frame is self locking



IH-156



IH-155



IH-150B



IH-150R



IH-151B



Code	Details	Overall Size WxDxH (mm)
IH-150B	Ezi-Pak Accessory Case- Blue (with clear lid)	370x432x85
IH-150R	Ezi-Pak Accessory Case- Red (with clear lid)	370x432x85
IH-151B	Ezi-Pak Accessory Case- Blue (with blue lid)	370x432x85
IH-156	Ezi-Pak Accessory Case Modular Frame (fits 2 cases, not included)	415x435x270
IH-155	*Ezi-Pak Accessory Case Modular Frame (complete with 2 cases)	415x435x270

\*This comes with red or blue lid cases (please specify colour when ordering)





## Clear Accessory Boxes

- Clear Compartment Accessory Boxes which are great for storing small parts and accessories
- All plastic construction
- Made from quality clear plastic for easy viewing
- Big range to suit your needs
- Protects goods from dirt & dust
- Quality catch for secure locking
- Endless uses

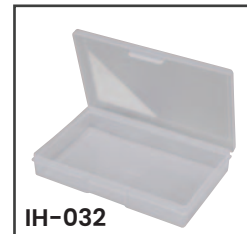

Code	Details	Overall Size LxWxH (mm)	Compartments	Ctn Qty
IH-031	Small - 1 compartment	188x118x31	1	12
IH-030	Small - 5 compartments	188x118x31	5	12
IH-033	Small - 10 compartments	188x118x31	10	12
IH-029	Medium - 1 compartment	195x157x48	1	12
IH-038	Medium - 6 compartments	195x157x48	6	12
IH-039	Medium - 14 compartments	195x157x48	14	12
IH-032	Medium Deep - 1 compartment	195x136x66	1	14
IH-092	Large - 1 compartment	310x200x48	1	5
IH-093	Large - 12 compartments	310x200x48	12	5
IH-094	Large - 18 compartments	310x200x48	18	5
IH-096	Large Deep - 1 compartment	310x200x80	1	3
IH-090	Large Deep - 3 compartments	310x200x80	3	3
IH-095	Large Deep - 6 compartments	310x200x80	6	3
IH-097	Extra Large- 20 compartments	350x270x55	20	5
IH-091	Extra Large Extra Deep - 1 compartment	350x270x100	1	3
IH-098	Extra Large Extra Deep - 8 compartment	350x270x100	8	3
IH-088	A4 Size - 1 Compartment	315x230x71	1	3



# Louvre Panel & Square Hole Boards & Accessories

- These wall mountable panels are available with louvre panel slots or square pegboard holes for hanging items
- Panels can be mounted onto benches, walls, racking, shelving trolleys and more
- Large range of hanging hooks accessories available



V7291

Rear View

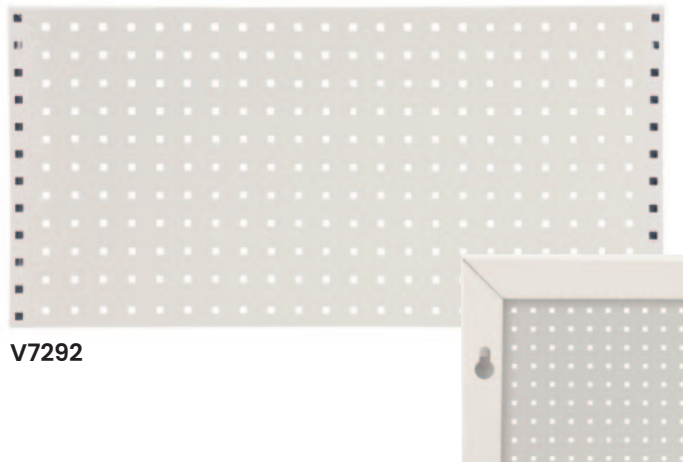

V7292

Rear View



V7280



V7281



V7282



V7283



V7284

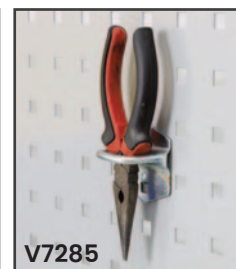

V7285



V7286



V7287



V7288



V7289



V7290

Code	Details	Overall Size (mm)	Unit Weight (kg)
V7291	Metal Louvre Panel Board	900x455x20 (WxHxD)	5kg
V7292	Metal Square Hole Pegboard	900x455x20(WxHxD)	5kg
V7280	Single Hook	25mm long	0.10g
V7281	Single Hook	75mm long	0.35g
V7282	Single Hook	150mm long	0.5g
V7283	Double Hook	25mm long	0.5g
V7284	Double Hook	75mm long	0.7g
V7285	U Shape Hook	23x35mm (LxW)	0.95g
V7286	U Shape Hook	70x25mm (LxW)	0.7g
V7287	3 Prong Hook	150mm long	0.14g
V7288	Round Hook	100x70mm (LxW)	0.85g
V7289	Spanner Holder	135mm long	0.4g
V7290	Screwdriver Holder	390mm long	0.46g



# Louvre Panels (Metal & ABS Plastic)

- These louvre panels are available in both metal and ABS plastic and can be used for many applications including workbenches, packing areas, walls, shelving etc
- 4 standard sizes in the metal louvre panel and 2 standard sizes in the ABS plastic panels



V7297

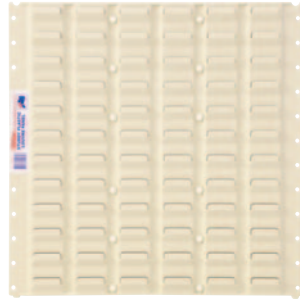

V7298

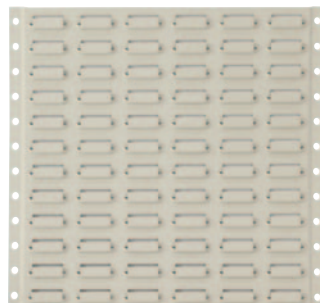

V7293



V7294

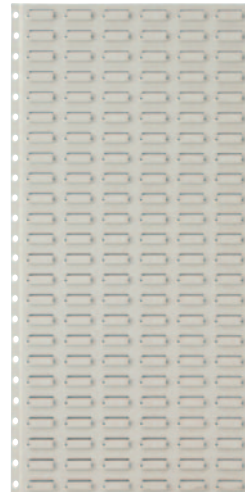

V7295

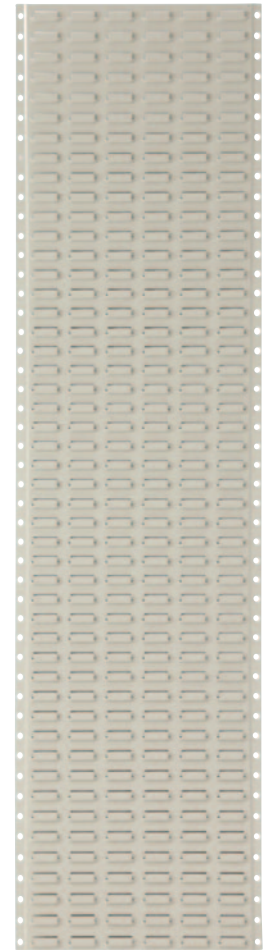

V7296

Code	Details	Overall Size WxH (mm)	Unit Weight (kg)
V7293	Metal Louvre Panel Board	455x455	2.5
V7294	Metal Louvre Panel Board	455x610	3.3
V7295	Metal Louvre Panel Board	455x914	5
V7296	Metal Louvre Panel Board	450x1800	10
V7297	ABS Plastic Louvre Panel Board	460x153	0.2
V7298	ABS Plastic Louvre Panel Board	460x460	0.5

**You  
May  
Also  
Like**



**Electric Workbenches - View online!**





# Enviro Plastic Stack & Nest Crates

## (Recycled Plastic)

- These recycled stack and nesting crates are injection moulded from tough, durable, UV resistant recycled polypropylene.
- Crates can stack or nest depending on which way around they are stored
- Size 4 and 4D are nest only



	Size #4	Size #4D	Size #7	Size #10	Size #15
<b>Code</b>					
<b>Details</b>					
<b>Internal Size LxWxD (mm)</b>					
<b>External Size LxWxD (mm)</b>					
<b>Capacity (L)</b>					
<b>Unit Weight (kg)</b>					
V7820	No. 4 Bins (Black Recycled)		390x280x120	430x323x127	13.5
V7821	No. 4D Bins (Black Recycled)		390x280x205	430x323x210	22
V7822	No. 7 Bins (Black Recycled)		490x330x200	645x413x210	32
V7823	No. 10 Bins (Black Recycled)		490x330x260	645x413x276	52
V7824	No. 15 Bins (Black Recycled)		490x330x385	645x413x397	68
<b>Lids to suit</b>					
V7825	Bin Crate Lids to suit No. 4 crates (Black Recycled)				-
V7826	Bin Crate Lids to suit No. 7-15 crates (Black Recycled)				-

# Stack & Nest Crate Dollies

- Industrial strength – made from heavy duty, durable recycled PP material
- V7840 & V7843: Zinc plated Castors
- V7841: Stainless Castors
- V7840 & V7841: Wheel wells to allow for stackable, secure storage (when not in use)
- V7840 & V7841: Rear castors with brakes to secure when stopped on an incline.
- Designed to fit our number 7, 10 or 15 stack and nest bin
- V7843 Suits Crate Base Sizes: 570x370mm & 545x355mm



Dollies pictured with No.15 Stack & Nest Crates



Code	Details	Load Capacity (kg)	Internal Dimensions (LxWxH) mm	Overall Dimensions (LxWxH) mm	Unit Weight (kg)
V7840	Enviro Dollie Dark Grey Frame	600	580x370x15 (lip)	615x405x190	6
V7841	Enviro Dollie Blue Frame	600	580x370x15 (lip)	615x405x190	6
V7843	Stack & Nest Crate Dollie Blue Frame	250	see main description	610x405x170	4.5



## Plastic Stack & Nest Crates (Virgin Plastic)

- These stack and nesting crates are injection moulded from tough, durable, UV resistant polypropylene. They are suitable for food handling, engineering, warehousing or distribution
- Crates can stack or nest depending on which way around they are stored
- Size 4 and 4D are nest only
- Available in 5 colours (please specify your preferred colour when ordering)
- Colours Available:



Blue Red White Green Yellow



Stack and Nestable

Code	Details	Size LxWxD (mm)	Capacity (L)	Unit Weight (kg)
V7830	No. 4 Bins	430x323x127	13.5	0.62
V7831	No. 4D Bins	430x323x210	22	0.77
V7832	No. 7 Bins	645x413x210	32	1.6
V7833	No. 10 Bins	645x413x276	52	1.8
V7834	No. 15 Bins	645x413x397	68	2.4
<b>Lids to suit</b>				
V7835	Bin Crate Lids to suit No. 4 crates (Black or white)			0.2
V7836	Bin Crate Lids to suit No. 7-15 crates (Black or white)			0.2

\*Please specify colour when placing order

# Access Plastic Bin Rack

- These access bin racks store and display products for easy access and stock picking
- Extra strong powder coated frames and beams
- Rack fits the No. 4D size bins (choice of 6 colours)
- Available in 2 standard sizes
- This rack can have castors fitted for easy maneuverability
- V8100 Access Plastic Bin Racking: 1800x1800x450mm
- V8101 Access Plastic Bin Racking: 2400x1800x450mm
- Add-on Bays available so you can make one continuous line of Access Bin Racking



### Bin Colours Available

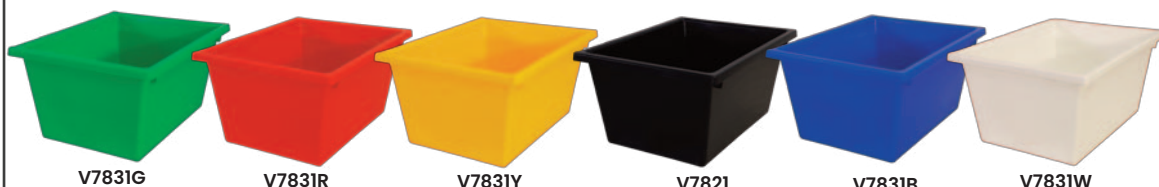

Code	Details	Unit Weight (kg)
V8100	Access Plastic Bin Rack (includes 20 plastic bins)	64
V8100A	Access Plastic Bin Rack Add on Bay to suit V8100	55
V8101	Access Plastic Bin Rack (includes 28 plastic bins)	88
V8101A	Access Plastic Bin Rack Add on Bay to suit V8101	80
V7326	Castor Kit to suit (includes 4 castors with brakes)	







## Access Stor-Pak Bin Rack

- These access Stor-Pak bin racks store and display products for easy access and stock picking
- Stor-Pak bins are available in Red, Green, Blue or Yellow
- Stor-Pak Bin Size: 410x440x210mm (Length x Depth x Height)
- Extra strong powder coated frames and beams
- Available in 2 standard sizes
- This rack can have castors fitted for easy maneuverability
- V8105 Access Plastic Bin Racking: 1800x1800x450mm
- V8106 Access Plastic Bin Racking: 2400x1800x450mm
- Add-on Bays available so you can make one continuous line of Access Bin Racking



V8105



V8105A



V8106



V8106A

### V7326 - Castor Kit



### Bin Colours Available



IH-065G

IH-065Y

IH-065OR

IH-065R

IH-065C

IH-065B

Code	Details	Unit Weight (kg)
V8105	Access Stor-Pak Rack (includes 16 plastic bins)	72
V8105A	Access Plastic Bin Rack Add on Bay to suit V8105	63
V8106	Access Stor-Pak Rack (includes 20 plastic bins)	97
V8106A	Access Plastic Bin Rack Add on Bay to suit V8106	88
V7326	Castor Kit to suit (includes 4 castors with brakes)	



## Multistaka Crates

- Industrial strength – made from heavy duty, durable PP material
- Food grade material
- Available in white and blue colour
- Lids available in white only



V7850W

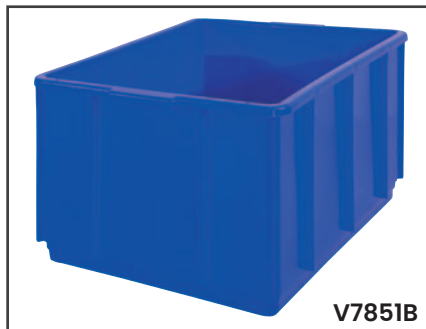

V7851B



V7852W



V7853



Code	Details	Internal Size LxWxH (mm)	Overall Size LxWxH (mm)	Unit Weight (kg)
V7850B	Blue Multistaka Crate – 13 Litre	375x275x120	432x324x127	0.78
V7850W	White Multistaka Crate – 13 Litre	375x275x120	432x324x127	0.78
V7851B	Blue Multistaka Crate – 22 Litre	375x275x210	432x324x203	1
V7851W	White Multistaka Crate – 22 Litre	375x275x210	432x324x203	1
V7852B	Blue Multistaka Crate – 32 Litre	375x275x300	432x324x305	1.4
V7852W	White Multistaka Crate – 32 Litre	375x275x300	432x324x305	1.4
V7853	Multistaka Crate Lid	-	438x330	-

## Plastic Pails With Lids

- These plastic pails are great for food and industrial applications
- 4 standard sizes available
- Stainless steel carry handle with plastic sleeve
- Australian made
- Supplied with lids
- Colour: White



Code	Details	Overall Size DxH (mm)	Unit Weight (kg)
V7854	Plastic Pail & Lid – 5L	204x176	0.62
V7855	Plastic Pail & Lid – 10L	260x270	0.77
V7856	Plastic Pail & Lid – 15L	280x332	1.6
V7857	Plastic Pail & Lid – 20L	280x410	1.8



## Standard Plastic Export Pallet

Excellent pallets for one way use with no fumigation or heat treatment required.

- Suitable for food processing plants and pharmaceutical industries
- Passes all export regulations – ISPM -15 compliant
- Able to be hot washed, steam cleaned and chemically sterilised
- No nails or splinters
- Re-sell value after usage
- Material: Made from recycled plastic
- 2 types available - 2 way entry & 4 way entry

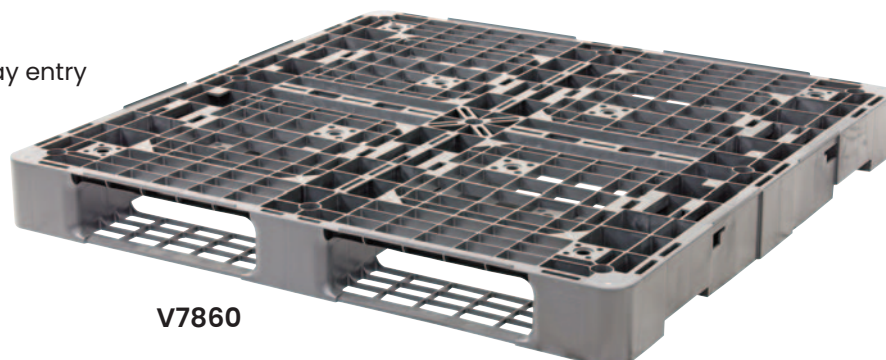

V7860



V7861

Code	Details	Static SWL (kg)	Overall Size LxWxH (mm)	Unit Weight (kg)
V7860	Standard Plastic Export Pallet-2 way entry	1000	1140x1140x120	7.7
V7861	Standard Plastic Export Pallet-4 way entry	1000	1100x1100x120	7.6

## Heavy Duty Hygiene Pallet

Heavy duty Environmentally friendly plastic pallets which are great for the food, pharmaceutical, grocery, printing, beverage and many other industrial applications.

- Static Capacity: 8000kg
- Beam Racking and Forklift Movement Capacity: 2000kg
- Drive-In Racking Capacity: 1000kg
- Material: Recycled polyethylene



**Please Note:** Capacity weights are approx only and we recommend that racking trials be carried out in each case

Code	Static SWL (kg)	Overall Size LxWxH (mm)	Unit Weight (kg)
V7865	10,000	1165x1165x150	33



## Vented Collapsible Bin & Lid

- Made from UV Stabilised PP
- Full recyclable and Food Grade Approved
- 3:1 Fold Down ratio
- 2 way forklift and pallet truck Entry
- Can safely stack up to 10 bins high when empty, 7 high at 300kg, 5 high at 500kg and 3 high and 700kg
- Pallet Rack Safe – Unique Positive Locking Base Design
- Racking Capacity 500kg
- Dynamic Capacity 1000kg
- Static Capacity 4000kg
- Bin Closed Dimensions (LxWxH): 1162x1162x270mm



V7811 - Collapsed

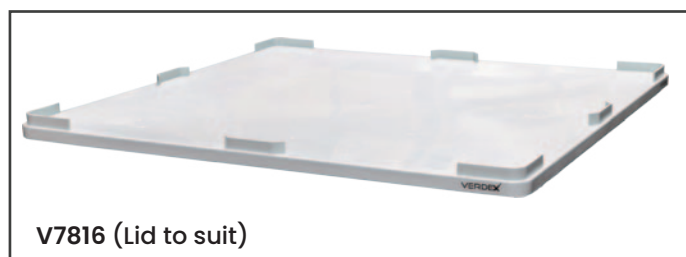

V7816 (Lid to suit)



V7811



V7812

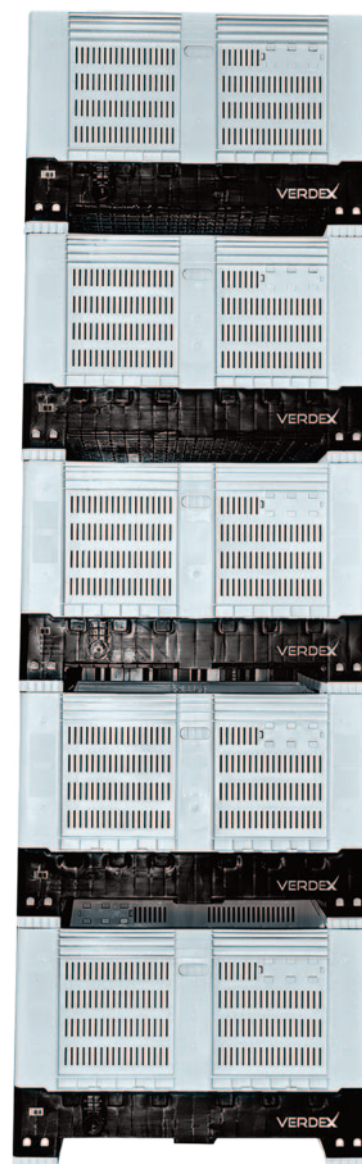

V7811 - Open & Stacked



Watch a video of this in operation on our website here: [www.verdex.com.au/V7811](http://www.verdex.com.au/V7811)



Code	Details	Volume (L)	Open Dimensions LxWxH (mm)	Internal Dimensions LxWxH (mm)	Unit Weight (kg)
V7811	Vented Collapsible Bin (Full Height)	730	1162x1162x780	1070x1070x630	46
V7812	Vented Collapsible Bin (Half Height)	352	1160x1160x460	1075x1075x300	35
V7816	Lid to suit V7811 & V7812	-	1172x1172x63	-	6.2



# Nally Plastic Mega Bins (Vented & Solid)

Designed for fruit and vegetable movement and retail high performance the Nally MegaBin is clearly the way of plastic produce bins in Australia. Nally Megabins are up to 40% lighter in weight than wood bins and the weight is constant as they don't absorb moisture. This allows for increased freight efficiencies of 4-5%. In practice you are able to transport 2-3 extra bins of fruit per semi-trailer load.

- Available in both solid and vented
- Mega Bin Rotator Base options available, to suit V7800 & V7810
- Standard pallet size (1165mm x 1165mm)
- Maximum load capacity: 500kgs



V7801 Mega Bin Rotator Base to suit V7800 & V7810



V7800 & V7810 - Stacked & pictured with V7815 (Lid to suit)



V7803 & V7800



V7810



V7800

Code	Details	Capacity	External Size LxWxH (mm)	Internal Size LxWxH (mm)	Unit Weight (kg)
V7800	Solid Mega Bin	780L	1165x1165x780	1082x1082x650	44
V7810	Vented Mega Bin	780L	1165x1165x780	1082x1082x650	44
V7815	Mega Bin Lid	-	1180x1180x35	-	10
V7801	Mega Bin Rotator Base	500kg	1070x900x140	1070x898x140	30
V7803	Mega Bin Rotator Base (with wheels)	500kg	1070x900x340	1070x898x140	38





# Mesh Transport Storage Cage

- Multi-purpose transport or storage cages which are great for storing products both indoor and outdoor.
- Pallet Rack Safe – unique positive locking base design for racking
- Features a Half Swing Removable Front Gate and a Hinged Removable Rear Gate
- Cages can be stacked 3 high, when loaded and 5 high when empty
- Finish: Zinc plated
- Supplied flatpacked
- Optional Gal Floor sold separately
- Optional Full Height Divider sold separately



Collapsed



Watch a video of this in operation on our website here: [www.verdex.com.au/V7530](http://www.verdex.com.au/V7530)



V7530 pictured with V7502



V7530 pictured with V7533



V7530 pictured with 2 x V7534

Code	Details	Load Capacity (kg)	Internal Size LxWxH (mm)	Overall Size LxWxH (mm)	Unit Weight (kg)
V7530	Mesh Storage Cage	1000	1070x1070x840	1160x1205x1041	80
V7502	Galvanised Floor to suit V7530	-	-	1140x1140x1.2	12
V7533	Lid to suit V7530	-	-	1130x1087x92	12.4
V7534	Full Height Divider to suit V7530	-	-	1135x750x41	6.2







# Low Height Storage Cage

- This Low Height Storage Cage is great for storing products both indoor and outdoor.
- Pallet Rack Safe – unique positive locking base design for racking
- Removable front gate
- Cages can be stacked 2 high when loaded
- 4 Way forklift & 2 Way Pallet Truck entry
- Finish: Zinc plated
- Supplied flatpacked
- Base Height: 125mm



Collapsed



Watch a video of this in operation on our website here:

[www.verdex.com.au/V7529](http://www.verdex.com.au/V7529)

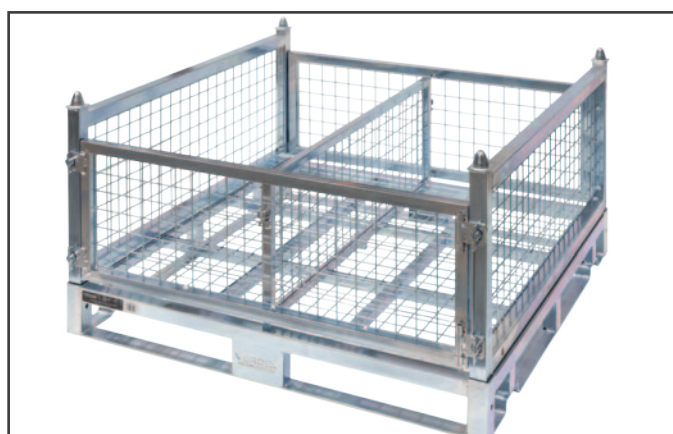

V7529 pictured with V7528

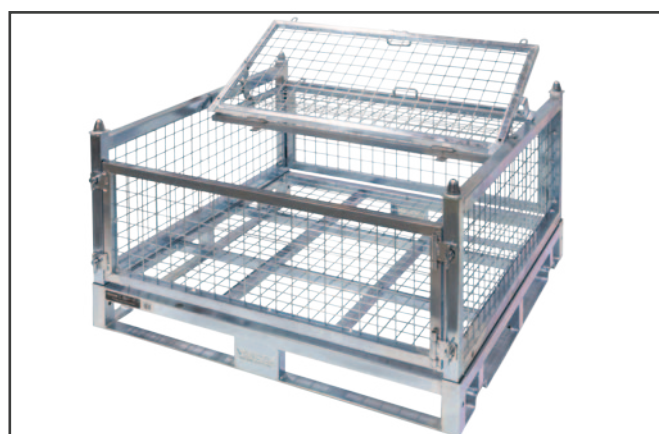

V7529 pictured with V7533

Code	Details	Load Capacity (kg)	Internal Size LxWxH (mm)	Overall Size LxWxH (mm)	Unit Weight (kg)
V7529	Low Height Storage Cage	1000	1070x1070x480	1160x1205x652	61
V7538	Half Height Divider to suit V7529	-	-	1125x345x25	4
V7533	Lid to to suit V7529	-	-	1130x1087x92	12.4



## Collapsible & Stackable Stillage Cage (Rectangular)

- Fork Pockets - 4 Side Fork Lift/2 Side Pallet Truck Access
- Pallet Racking Compatible (beam lock at long side)
- 3 Sided Half Drop Down Gate
- 1 Sided Swing Gate (Short Side)
- Pallet Rack Safe - Unique Locking Base Design
- Quick Collapsible sides so the unit can be quickly folded, stored and transported in the knock-down position
- Zinc Finish
- Compact Design - can be stacked when collapsed
- Optional Wheel Kit
- 2 License Plates on Short Sides
- Stackable (3) High Loaded, (4) High Empty, (6) High Collapsed
- 4 x Heavy Duty Low Profile Castors (2 x Swivel & 2 x Fixed)
- Fork Pocket Size: 132x85mm
- Fork Pocket Centre: 250mm

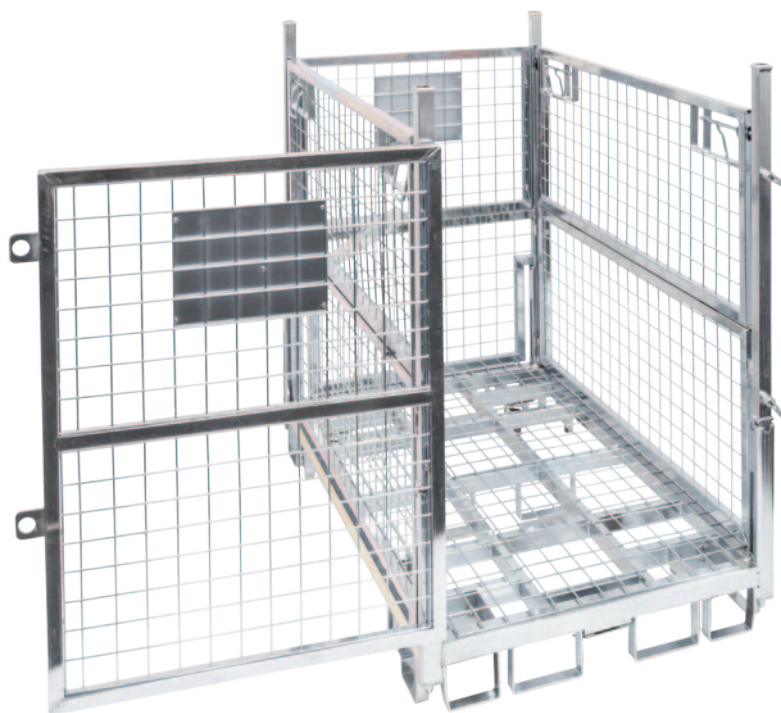

Pictured with V7562

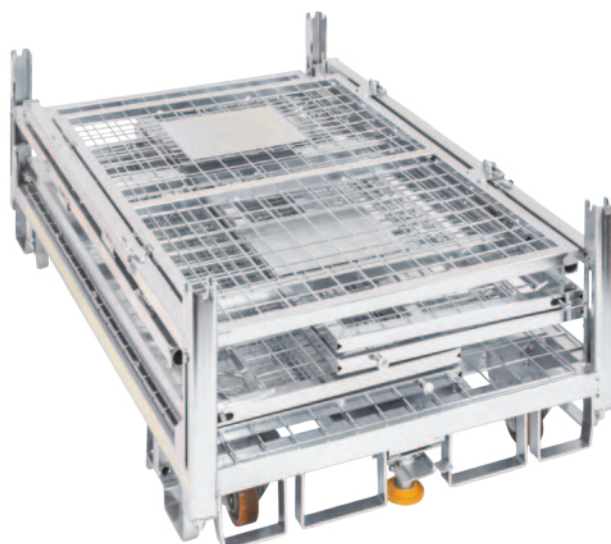

Watch a video of this in operation on our website here: [www.verdex.com.au/v7561](http://www.verdex.com.au/v7561)



Code	Details	Load Capacity (kg)	Internal Size LxWxH (mm)	Overall Size LxWxH (mm)	Collapsed Height (mm)	Unit Weight (kg)
V7561	Collapsible & Stackable Stillage Cage	500	1090x680x925	1150x750x1170	425	74
V7562	Optional Wheel Kit to suit V7561					





# Collapsible and Stackable Stillage Cage

- Multi-purpose transport or storage cages which are great for storing products both indoor and outdoor.
- Great for storing products both indoor and outdoor
- Pallet Rack Safe – Unique Positive Locking Base Design
- Front and rear gates are removable and half fold down
- Quick collapse sides so the unit can be quickly folded, stored and transported in the knock-down position
- 4 way pallet truck and forklift entry
- Cages can be stacked 3 high when loaded and 10 high folded
- Finish: Zinc plated
- Mesh Size: 100x50x6mm
- If fitted with V7542 Wheel Kit, the overall load capacity of the V7541 will reduce to 800kg

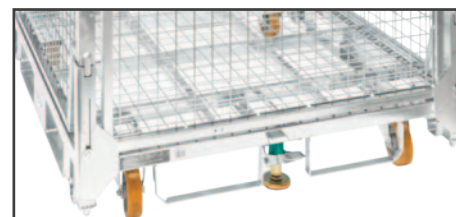

V7541 pictured with V7542



V7541 pictured with V7534



V7541 pictured with V7533



V7541 Collapsed & Stacked



Watch a video of this in operation on our website here: [www.verdex.com.au/V7541](http://www.verdex.com.au/V7541)



Code	Details	Load Capacity (kg)	Internal Size (mm)	Overall Size LxWxH (mm)	Unit Weight (kg)
V7541	Collapsible & Stackable Stillage Cage	1200	1035x1035x805	1125x1125x1040	87
V7533	Lid to suit V7541	-	-	1130x1087x92	12.4
V7534	Full Height Divider to suit V7541	-	-	1135x750x41	6.2
V7542	Wheel Kit to suit V7541				





## Wire Pallet Cages

- Convert your pallets into cages with the quick and easy to use cages.
- Ideal for storing odd or awkward shaped goods/products
- Can be folded down flat for easy storage when not in use
- Mesh Size: 100x50mm - 6mm
- Pallet not included



Watch a video of this in operation on our website here: [www.verdex.com.au/V7514](http://www.verdex.com.au/V7514)



V7514



V7515

Code	Details	Overall Size LxWxH (mm)	Unit Weight (kg)
V7514	Half Height Wire Pallet Cage	1195x1170x400	28
V7515	Full Height Wire Pallet Cage	1195x1170x800	44

## Galvanised Mesh Cage

- These mesh cages are an excellent form of warehouse and yard storage.
- These units are stackable as well as having the capability of being stored on pallet racking
- Can be folded down flat for easy storage when not in use
- Can be safely stacked 2 high when in use



V7519



Watch a video of this in operation on our website here: [www.verdex.com.au/V7518](http://www.verdex.com.au/V7518)



Code	Details	Load Capacity (kg)	Folded Height (mm)	Mesh Size (mm)	Overall Size WxDxH (mm)	Unit Weight (kg)
V7518	Galvanised Mesh Cage	1000	210	100x50x6	1150x1150x890	64
V7519	Wheel Kit to suit V7518					



# Pallet Cages

- Multi-purpose transport or storage cage
- Great for storing products both indoor and outdoor
- These cages can also be stored on pallet racking
- V7509 features a drop down swing gate
- V7510 features a double swing gate
- Stackable Height: 2 high loaded, 4 high empty
- Supplied with a hardwood timber pallet
- Finish: Zinc Plated
- Load Capacity: 1000kg



V7510



V7509



V7509 pictured with V7528



V7509 pictured with V7533



V7510 pictured with V7534



V7510 pictured with V7533

Code	Details	Internal Size LxWxH (mm)	Overall Size LxWxH (mm)	Unit Weight (kg)
V7509	Stillage Pallet Cage (Half Height)	1080x1080x448	1200x1200x655	27
V7538	Half Height Divider to suit V7509	-	1125x345x25	4
V7510	Stillage Pallet Cage (Full Height)	1080x1080x825	1205x1165x1028	41
V7534	Full Height Divider to suit V7510	-	1135x750x41	6.2
V7533	Lid to to suit V7509 & V7510	-	1130x1087x92	12.4



# Stackable Stillage Cage

These stackable stillage cages are an excellent form of warehouse and yard storage. Designed to store long awkward objects for easy transport, these units may be stacked to make use of the vertical space in your warehouse.

- Fits standard Australian size pallets including Chep and Loscam
- Can be safely stacked 3 high when in use
- Finish: Zinc plated
- Base Material Size: RHS 30x60x1.8mm
- Post Size: 60x2.5mm
- Cupped feet add an additional 100mm to the external size (50mm per side)
- Clearance between ground and bottom frame is 110mm
- Clearance between stillages when stacked is 1545mm

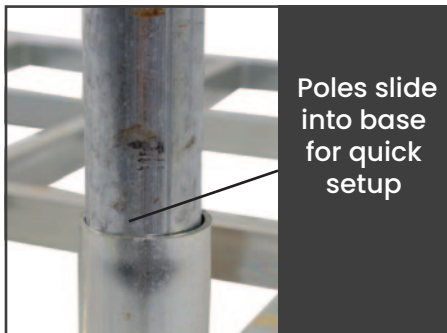

Watch a video of this in operation on our website here, [www.verdex.com.au/V7525](http://www.verdex.com.au/V7525)



Code	Load Capacity (kg)	Post Height from Top of Base (mm)	Internal Size LxWxH (mm)	External Size LxWxH (mm)	Base Height (mm)	Unit Weight (kg)
V7525	1000	1490	1250x1250x1490	1390x1390x1655	170	54





## Large Stackable Stillage Cage

These stackable stillage cages are an excellent form of warehouse and yard storage. Designed to store long awkward objects for easy transport, these units may be stacked to make use of the vertical space in your warehouse.

- Can be safely stacked 2 high fully loaded, 4 high empty
- Galvanised Finish
- Load Capacity: 1000kg
- Stillage Cage comes with optional accessories to suit.



V7589 Eye Nut for Lashing



V7588 Stopper/Divider

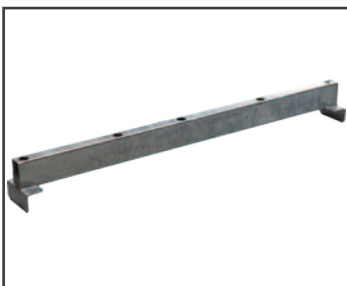

V7587 Fork Entry Bar

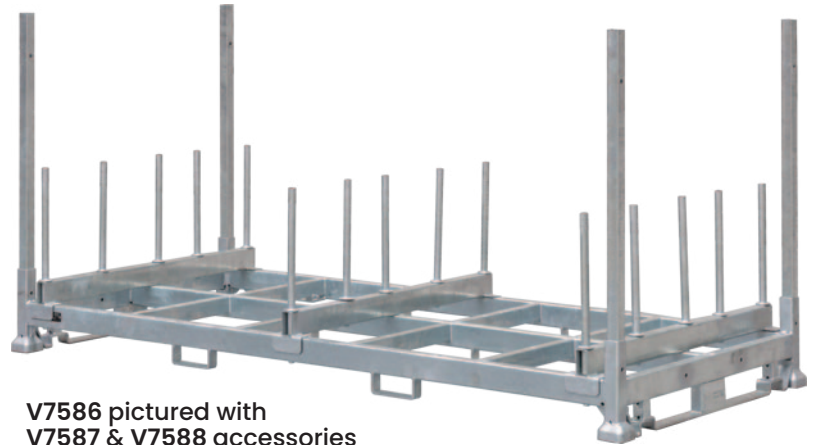

V7586 pictured with V7587 & V7588 accessories



V7586 in use & stacked 2 high

Code	Details	Fork Pocket Centre (mm)	Fork Pocket Size (mm)	Internal Size LxWxH (mm)	Overall Size LxWxH (mm)	Unit Weight (kg)
V7586	Large Stackable Stillage Cage	850	154x62	2410x1165x1025	2550x1165x1200	100
V7587	Fork Entry Bar to suit V7586	-	-	-	130x12x114	4.5
V7588	Stopper/Divider to Suit V7586	-	-	-	50x50x480	0.7
V7589	Eye Nut to suit V7586					
V7907	Towing Set to suit V7586					
V1283	Castor Kit to suit V7586 (160mm 2 x Swivel with brakes & 2 x fixed)					

## Double Width Storage Cage (Full Height)

- Front and rear gates fold down allowing for safe, easy and fast access to goods
- Pallet Rack Safe – unique positive locking base design
- Cage can be collapsed or assembled in seconds
- 4 Way forklift access & pallet truck entry
- Anti-tip base design
- Zinc plated finish
- Optional Full Height Divider sold seperately
- Stackable 2 high loaded, and 4 high empty
- Collapsed Height: 320mm



Stacked



V7540 Pictured with V7542



V7540 pictured with V7543 & V7534

Collapsed



Code	Details	Load Capacity (kg)	Internal Size LxWxH (mm)	Overall Size LxWxH (mm)	Unit Weight (kg)
V7540	Double Width Storage Cage (Full Height)	1050	2100x1085x810	2200x1160x1055	125
V7534	Full Height Divider to suit V7540	-	-	1135x750x41	7
V7543	Lid to suit V7540	-	-	1143x1040x60	21
V7542	Wheel Kit to suit V7540	-	-	-	-





## Double Width Storage Cage (Low Height)

- Front and rear gates are removable
- Pallet Rack Safe – unique positive locking base design
- Cage can be collapsed or assembled in seconds
- 4 Way forklift access & pallet truck entry
- Anti-tip base design
- Zinc plated finish
- Optional Half Height Divider sold separately
- Optional Wheel kit sold separately
- Optional Half Height Divider sold separately
- Optional lid sold separately
- Stackable 4 high loaded, and 6 high empty
- Collapsed Height: 320mm



Pictured with V7543 &amp; V7542

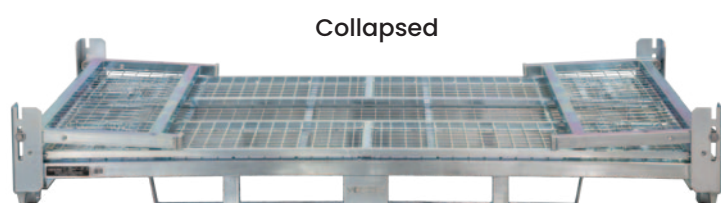

Collapsed



Stacked

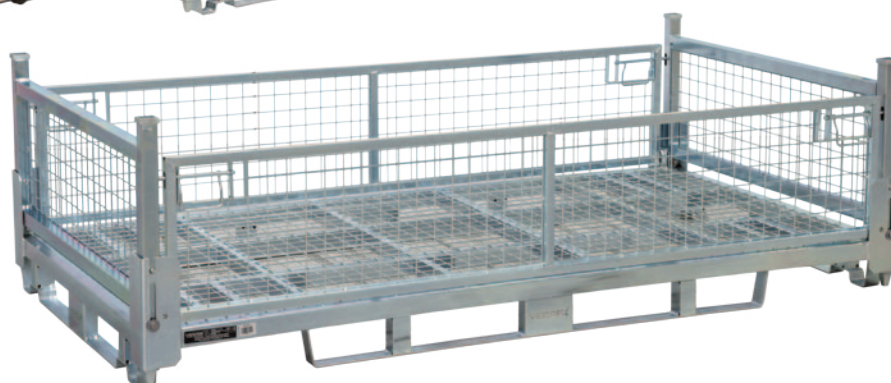

Code	Details	Load Capacity (kg)	Internal Size LxWxH (mm)	Overall Size LxWxH (mm)	Unit Weight (kg)
V7539	Double Width Storage Cage (Low Height)	1050	2100x1085x430	2200x1160x660	110
V7538	Half Height Divider to suit V7539	-	-	1125x345x25	4
V7543	Lid to suit V7539	-	-	1143x1040x60	21
V7542	Wheel Kit to suit V7539	-	-	-	-



## Crane Pallet Cage

- The V7565 Crane Pallet Cage is a lightweight, affordable solution for storing and transporting loose goods by crane or forklift.
- Fully opening front gate for easy loading and unloading
- Stacking feet allow cages to be stacked 3 high when empty or 2 high when loaded
- Suitable for storage on pallet racking
- Fitted with 4 point lift crane lugs and forklift pockets
- Sheet metal floor fitted standard
- Zinc finish
- Fork Pocket Size: 245x80mm
- Fork Pocket Centres: 452mm
- Supplied standard as flatpack for on-site assembly or supplied fully assembled (V7565A)



Code	Details	Working Load Limit (kg)	Internal Dimensions LxWxH (mm)	Overall Size LxWxH (mm)	Unit Weight (kg)
V7565	Crane Pallet Cage	1000	1060x1060x900	1250x1250x1100	110
V7565A	Crane Pallet Cage Assembly Available				



# Forklift Safety Cage/Work Platform

- Manufactured to meet relevant Australian Standards
- Zinc plated finish
- Designed to carry 2 persons (250kg max)
- Mesh safety screen
- Toe boards all sides with skid resistant floor plate
- Inward opening, self closing door
- Internal handrail with safety loops to hook safety harness
- Full length fork sleeves
- Castors can be fitted to the bottom of cage for easy manoeuvrability in warehouse or yard
- Fork Pocket Size: 160x60mm
- Fork Pocket Centres: 625mm
- HCG: 550mm
- Supplied as flatpack for easy storage and transport however can be ordered with assembly

NO MORE THAN 2 PERSONS MAY BE LIFTED.  
 WEIGHT OF PLATFORM 134KGS.  
 THE LOAD INCLUDING PERSONNEL & EQUIPMENT  
 SHALL NOT EXCEED 250KG  
 USE ONLY ON INDUSTRIAL TRUCKS HAVING A  
 CAPACITY OF 1800KG (COUNTERBALANCED) OR  
 1080KG (REACH TRUCK) AS APPROVED.  
 DO NOT USE IN PROXIMITY TO LIVE ELECTRICAL  
 EQUIPMENT.  
 FOR USE ONLY AS APPROVED BY STATE  
 STATUTORY AUTHORITY.



Tool tray supplied as standard



Fork cage flatpacked

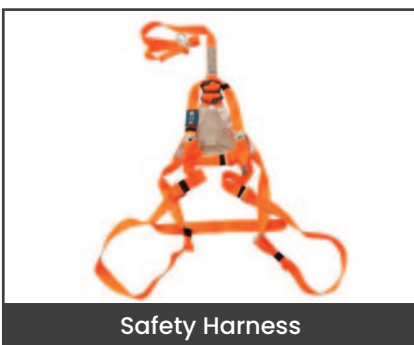

Safety Harness

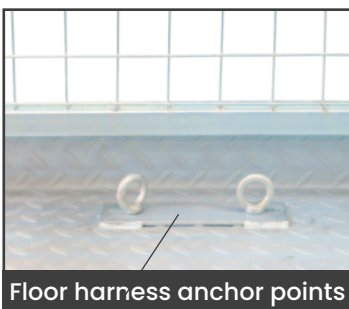

Floor harness anchor points

Code	Details	Internal Floor Dimensions (mm)	Overall Height (mm)	Height to Railing (mm)	Unit Weight (kg)
V4000	Forklift Safety Cage (supplied flatpacked)	1075x1015	2070	1000	124
V4002	Full Body Safety Harness & Lanyard				
V4000A	Forklift Safety Cage Assembly Available				





## Forklift Goods Cage

- Designed for the safe and easy storage and transport of goods including furniture and whitegoods.
- Manufactured in accordance with Australian Standard AS 2359.1 and is ideal for transportation of goods between ground and mezzanine levels.
- Hinged front ramp allows for trolley access
- Goods secured by locking ramp in the vertical position and attaching two safety chains
- Zinc sides with enamel paint finish on base
- Load Centre: 600mm



Code	Details	Working Load Limit (kg)	Fork Pocket Centres (mm)	Fork Pocket Size (mm)	Unit Weight (kg)
V4005	Forklift Goods Cage	1500	800	185x85	130
V4005A	Forklift Cage Assembly Available				

**You  
May  
Also  
Like**



**Craneable Storage Bin - See page 262**





## Forklift Ramped Goods Platform

- Allows safe loading and transport of bulky goods, equipment & machinery
- Ramp access for ease of loading & unloading
- Fork pockets fitted for transport and placement of skid by forklift
- 4 flip-up lashing points to safely secure various load sizes
- Kick plates help prevent objects from falling off the platform
- Steel frame and safety chains for added load safety during transport
- Non-slip tread plate floor and ramp
- Reinforced underside to eliminate steel fatigue
- Enamel paint finish
- Fork Pocket Centres: 660mm

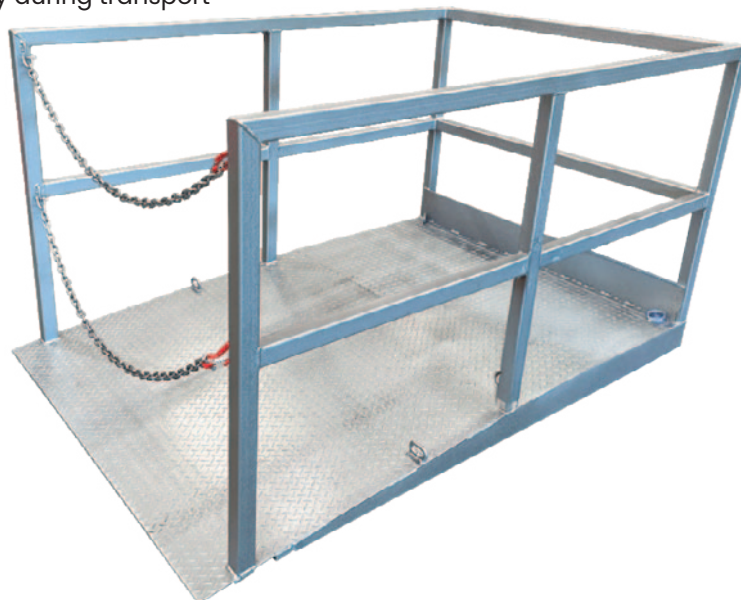

Code	Working Load Limit (kg)	Platform Size (mm)	Overall Dimensions LxWxH (mm)	Fork Pocket Size (mm)	Fork Pocket Centres (mm)	Unit Weight (kg)
V4006	2000	1800x1385	2115x1500x1110	170x60	660	310

## Forklift / Crane Transport Platform (with Folding Ramp)

- 600mm fold-up ramp allows for easy loading
- Ramp secured by chain and snap hooks on either side
- 4 point lift lugs and 3-way fork pockets for easy transport and placement of skid
- Multiple tie down points allow various load sizes to be safely secured
- Raised side plates prevent machinery from sliding off the side of skid
- Tread plate floor and ramp for traction
- Reinforced underside to eliminate steel fatigue
- Recessed base to suit storage in standard pallet racking
- Zinc finish

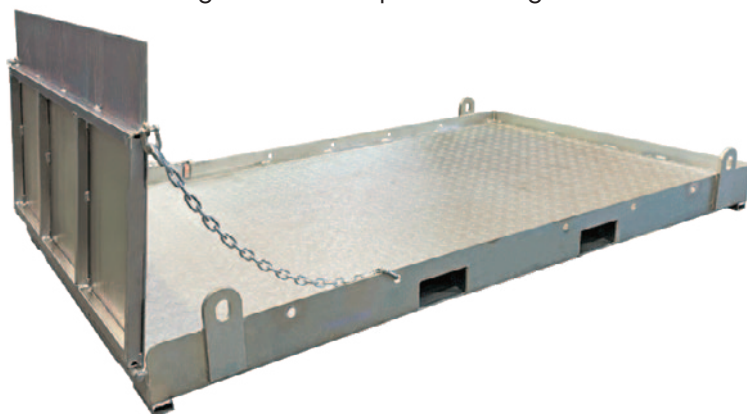

Code	Working Load Limit (kg)	Platform Size (mm)	Overall Dimensions LxWxH (mm)	Fork Pocket Size (mm)	Fork Pocket Centres (mm)	Unit Weight (kg)
V4035	1000	2000x1150	2610x1175x230	140x65	550	180



# Heavy Duty Steel Longspan Shelving (450 & 600mm Deep)

- This heavy duty longspan shelving system is a strong and versatile shelving system, which is similar to pallet racking just in a similar profile, which is great for storing small parts and archives.
- This system is supplied standard with 3 adjustable shelves however extra shelf levels can be ordered for each set
- Comes standard with steel shelves (2 pieces per level)
- End frames are supplied assembled for quick and easy setup
- Standard longspan 450mm and 600mm deep stock sizes are listed below
- Step beams which the steel decks sit flush with the beam
- Shelf Capacity: 390kg/level - 1800(L) Beam, 290kg/level - 2400(L) Beam
- For overall bay length add 60mm per frame

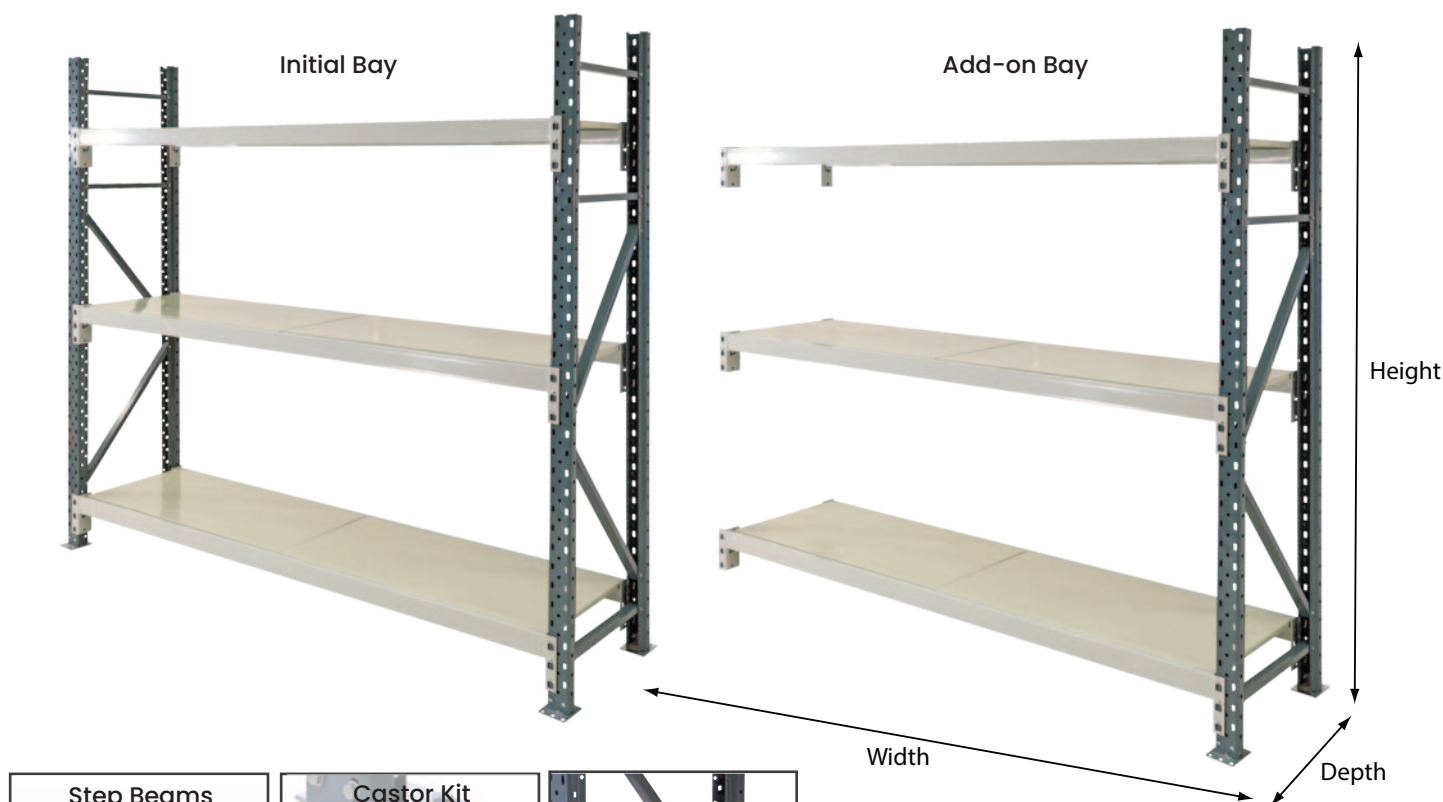

Watch a video of this in operation on our website here: [www.verdex.com.au/V8000](http://www.verdex.com.au/V8000)

Height (mm)	Width (mm)	Depth (mm)	Starter Bay Code	Add On Bay Code	Extra Shelf Level Code
1800	1800	450	V8000	V8001	V8008
1800	1800	600	V8002	V8003	V8009
2400	1800	450	V8004	V8005	V8008
2400	1800	600	V8006	V8007	V8009
1800	2400	450	V8015	V8016	V8023
1800	2400	600	V8017	V8018	V8024
2400	2400	450	V8019	V8020	V8023
2400	2400	600	V8021	V8022	V8024

V7326 Castor Kit to suit Longspan Shelving (includes 4 castors with brakes)



# Heavy Duty Steel Longspan Shelving (900mm Deep)

- This heavy duty longspan shelving system is a strong and versatile shelving system, which is similar to pallet racking just in a similar profile, which is great for storing small parts and archives.
- This system is supplied standard with 3 adjustable shelves however extra shelf levels can be ordered for each set
- Comes standard with steel shelves (2 pieces per level)
- End frames are supplied assembled for quick and easy setup
- Standard longspan 900mm deep stock size is listed below
- Step beams which the steel decks sit flush with the beam
- Shelf Capacity: 390kg/level - 1800(L) Beam, 290kg/level - 2400(L) Beam
- For overall bay length add 60mm per frame

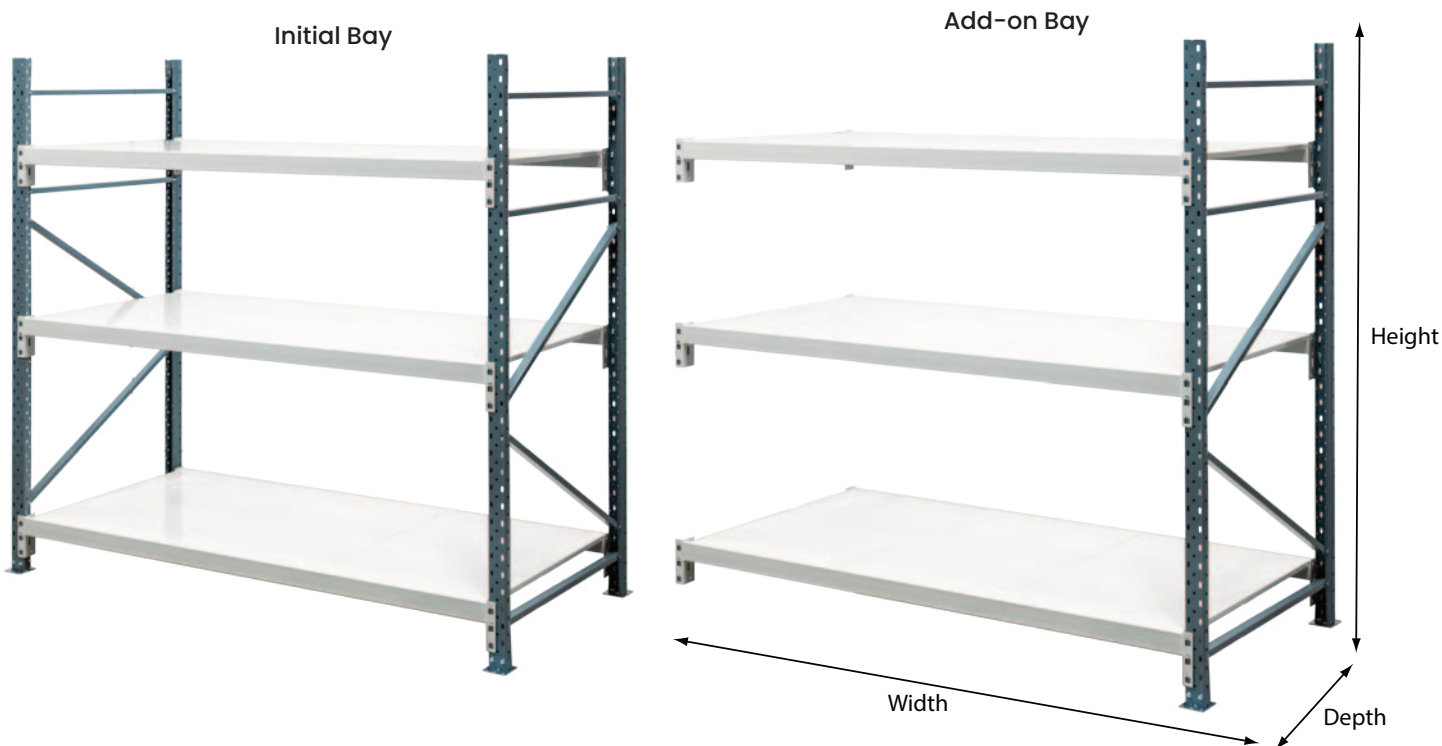

Watch a video of this in operation on our website here: [www.verdex.com.au/V8410](http://www.verdex.com.au/V8410)

Height (mm)	Width (mm)	Depth (mm)	Starter Bay Code	Add On Bay Code	Extra Shelf Level Code
1800	1800	900	V8410	V8411	V8418
2400	1800	900	V8412	V8413	V8419
1800	2400	900	V8414	V8415	V8418
2400	2400	900	V8416	V8417	V8419

V7326 Castor Kit to suit Longspan Shelving (includes 4 castors with brakes)





## Heavy Duty Longspan Shelving (with Mesh Shelves)

- This heavy duty longspan shelving system is a strong and versatile shelving system, which is similar to pallet racking just in a similar profile, which is great for storing small parts and archives.
- This system is supplied standard with 3 adjustable shelves however extra shelf levels can be ordered for each set
- Comes standard with mesh shelves (2 pieces per level)
- End frames are supplied assembled for quick and easy setup
- Standard longspan 450mm and 600mm deep stock sizes are listed below however other configurations can be ordered on request
- Step beams which the mesh decks sit flush with the beam
- Shelf Capacity: 390kg/level - 1800(L) Beam, 290kg/level - 2400(L) Beam
- For overall bay length add 60mm per frame

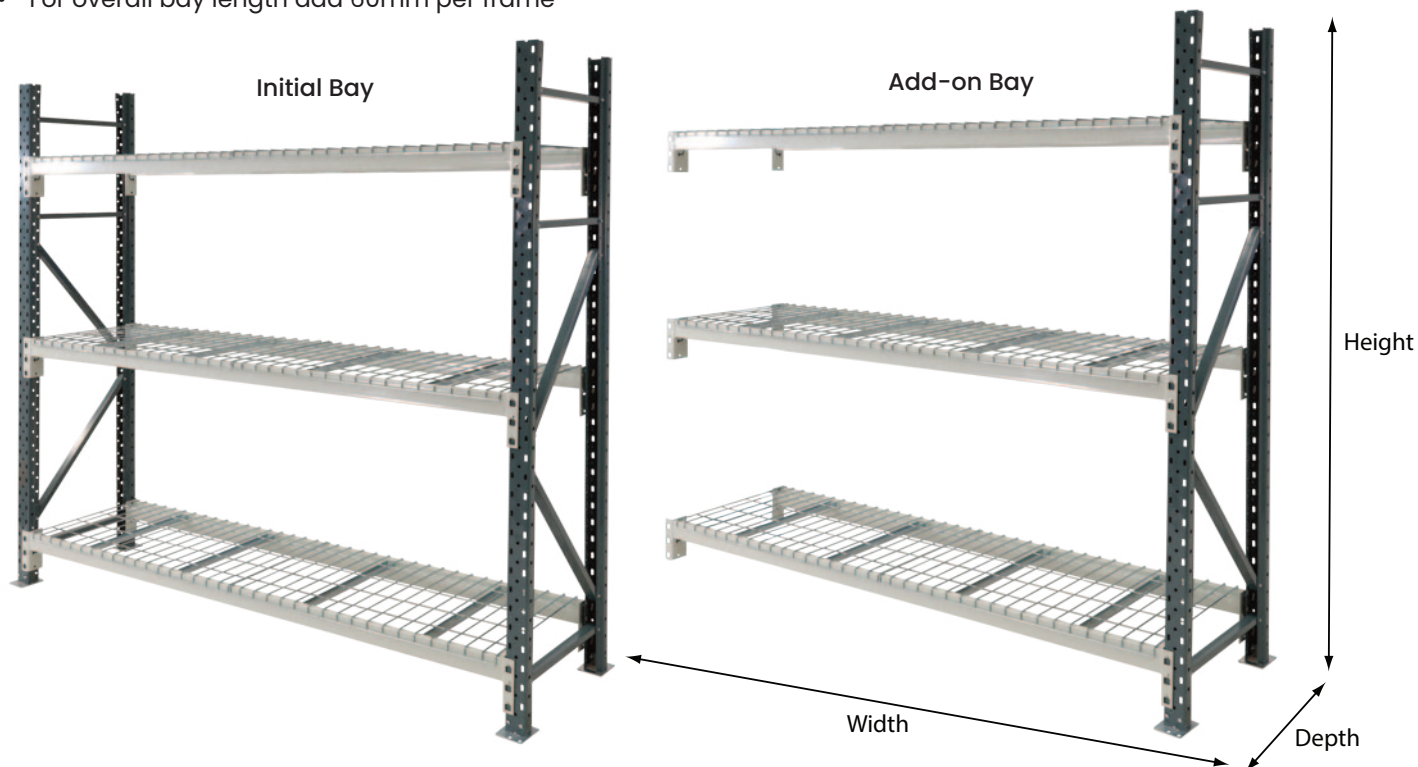

Height (mm)	Width (mm)	Depth (mm)	Starter Bay Code	Add On Bay Code	Extra Shelf Levels
1800	1800	450	V8030	V8031	V8038
1800	1800	600	V8032	V8033	V8039
2400	1800	450	V8034	V8035	V8038
2400	1800	600	V8036	V8037	V8039
1800	2400	450	V8045	V8046	V8053
1800	2400	600	V8047	V8048	V8054
2400	2400	450	V8049	V8050	V8053
2400	2400	600	V8051	V8052	V8054

V7326 Castor Kit to suit Longspan Shelving (includes 4 castors with brakes)



# Pallet Straighteners

- Pallet Straighteners are beneficial tools in warehouse settings, as they help maintain efficiency, safety and organization.
- Designed to help maximise storage capacity and prevent accidents by securing the load, ensuring the pallets are properly positioned
- Steel construction
- Powder coated, blue finish



V1490



V1495

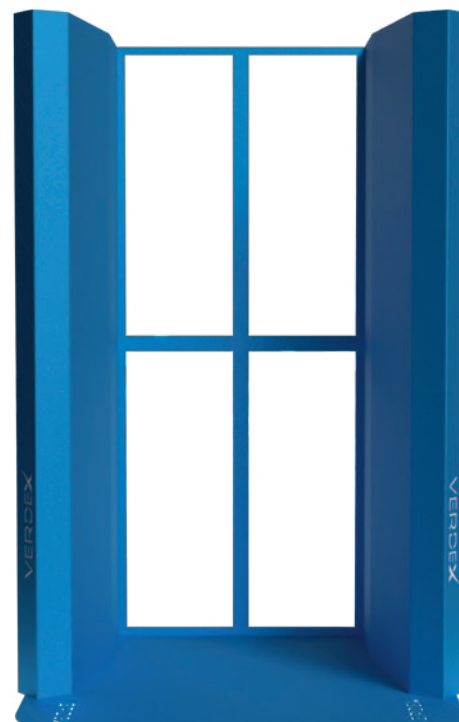

V1496



V1496 pictured with Steel Pallets



V1495 pictured with Timber Pallets

Code	Details	Overall Size LxWxH (mm)	Unit Weight (kg)
V1490	Pallet Straightener (10 pallets)	1910x2000x1505	315
V1495	Pallet Straightener (15 pallets)	1910x2000x2255	410
V1496	Pallet Straightener (20 pallets)	1910x2000x3010	490

## Pallet Racking End Protectors

Pallet Racking End Protectors are a highly effective solution for preventing damage to racking and inventory by forklifts.

No matter how good your forklift drivers are, there will always be sometime when an accident or mistake happens when they crash into the pallet racking. You can avoid major injuries and pallet rack damage by installing these protection guards.

Damage and failure not only cause serious safety issues but disassembling, repair, reassembling and reloading of pallet racks add significantly to running costs.

- Single Bay End Protector to suit 838mm frame
- Double Bay End Protector to suit 838mm frame + 430mm space + 838mm frame
- Conforms to relevant Australian Standards

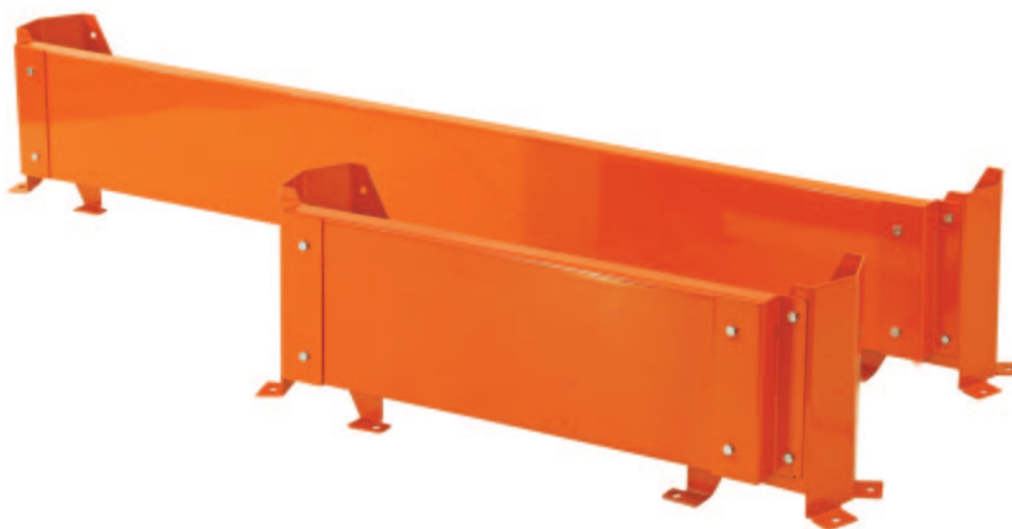
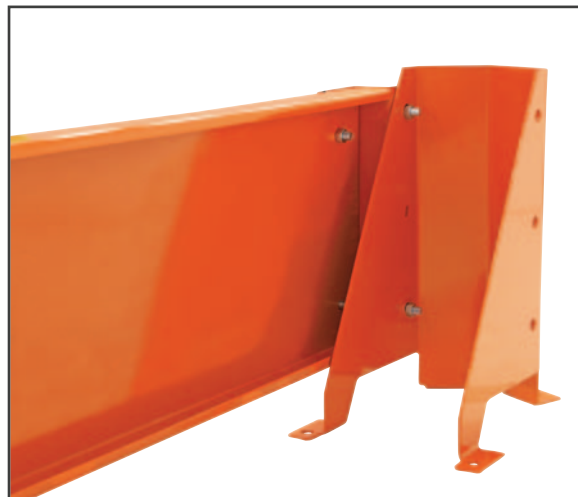

V7405



V7406

Code	Description	Height (mm)	Overall Length (mm)	Unit Weight (kg)
V7405	Racking End Protector (to suit single bay of racking)	400	1080	15
V7406	Racking End Protector (to suit double bay of racking)	400	2350	27





## Pallet Racking Mesh Decks

- Our mesh decks are made to suit almost any standard pallet racking system
- Other sizes can be made to order
- Comes complete with support bars
- 2 pieces per beam
- Suitable for skids & pallets of heavier weights
- Galvanised finish

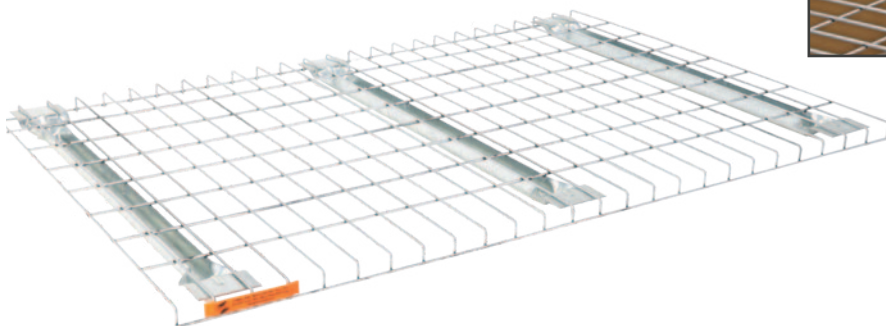

Code	Details	Load Capacity (kg)	Width (mm)	Depth (mm)	Unit Weight (kg)
V7462	Pallet Racking Mesh Decks (suits 2600mm beams)	1000	1250	840	10.6
V7463	Pallet Racking Mesh Decks (suits 2750mm beams)	1000	1350	840	11.6

## Pallet Racking Column Guards

- Pallet Racking Column Guards are a highly effective solution for preventing damage to racking and inventory by forklifts.
- No matter how good your forklift drivers are, there will always be sometime when an accident or mistake happens when they crash into the pallet racking.
- You can avoid major injuries and pallet rack damage by installing these protection guards.
- Damage and failure not only causes serious safety issues but disassembling, repair, reassembling and reloading of pallet racks add significantly to running costs.
- Conforms to relevant Australian Standards



Top View



Code	Overall Size HxD (mm)	Unit Weight (kg)
V7400	400x220	5



## Rolling Metal Step Stool

- This rolling step stool is the most popular in our range
- Spring loaded castors for rolling which spring upwards when you step on the stool
- Non-Slip rubber surface on both steps
- Powder coated steel construction
- Castors: 30mm



Code	Load Capacity (kg)	Top Step Dia. (mm)	Bottom Step Dia. (mm)	Bottom Step Height (mm)	Base Dia. (mm)	Height to Top Step (mm)	Unit Weight (kg)
V4100	150	290	330	225	435	430	4.5

## General Purpose Plastic Step Stool

- Ideal for offices, libraries, and archive areas
- Strong plastic construction with non-slip steps
- Anti-skid rubber feet



Code	Load Capacity (kg)	Platform Size (mm)	Height (mm)	Overall Size LxWxH (mm)	Unit Weight (kg)
V4101	175	390x390	370	510x510x265	3.3

## All Purpose Step Ladders

- Compact Folding Design
- Anti-Slip Treads
- Made From Highly Durable Steel
- Capacity: 120kg



Code	Description	Ladder Open Height (mm)	Platform Height (mm)	Unit Weight (kg)
V4140	All Purpose Step Ladder (2 Steps)	1100	450	6
V4141	All Purpose Step Ladder (3 Steps)	1250	680	8



## Fibreglass Industrial Platform Ladders

- Available in 3 platform heights: 900mm, 1200mm and 1500mm
- Large anti-skid work platform with raised edges - keeps feet in side the platform for greater safety and comfort
- One piece, smooth operation - simply folds out and locks
- Platform size: 600x600mm
- Rated to 150kgs
- Complies to AS/NZS 1892:1998



V4230 Safety Gate Kit



Anti-skid platform



V4220 Castor Kit

Code	Details	No. of Steps	Platform Height (mm)	Unit Weight (kg)
V4210	Fibreglass Platform Ladder (1800mm high)	3	900	13
V4211	Fibreglass Platform Ladder (2100mm high)	4	1200	15
V4212	Fibreglass Platform Ladder (2400mm high)	5	1500	17
V4220	Platform Ladder Castor Kit to suit Fibreglass Platform Ladders			
V4230	Platform Ladder Safety Gate Kit to suit Fibreglass Platform Ladders			



## Verdex Access Platform Ladders

These Access Platform Ladders are designed for safe, easy and efficient use in warehousing, vehicle maintenance, mining, aviation and heavy industry workplaces.

- Access Platform 2-In-1 With Bonus Work Shelf
- Super strong 'fully welded' design fabricated from heavy duty aluminium
- Steel bracing under bottom tread and side bracing provides additional protection from impact damage
- 100mm deep treads improve safety and comfort when climbing
- Suited to 'high frequency' use
- Walk-thru' design for stock picking and access to mezzanine floors, vehicle access and warehousing
- Large 125mm wheels – improved portability and 'easy glide' action
- Large stable work platform (safe and stable) – 600mm x 710mm
- Manually operated braking system with high-vis powder coated activation arm helps minimize unauthorised access
- Two safety gates fitted (a 2 in 1 product allowing for walk-thru access)
- Toeboard on three sides (helps secure tools/accessories)
- Made to AS/NZS 1892.1
- 200kg load rating
- Handrail Height: 1000mm
- Industrial duty rating for use on commercial sites
- Meets Work Cover requirements (safety gate + 900mm handrail, toeboard)
- Supplied as a 'flat pack' for optimal transporting however can be assembled on request

8 Step Access Platform Ladder





V4150



V4151



V4152



V4153



V4154



V4155



Watch a video of this in operation on our website here:

[www.verdex.com.au/V4150](http://www.verdex.com.au/V4150)



Code	Details	Platform Height (mm)	Reach Height (m)	Open Size LxWxH (mm)	Unit Weight (kg)
V4150	Access Platform Ladder - 3 Step	792	2.8	1315x797x1677	35
V4151	Access Platform Ladder - 4 Step	1056	3.1	1321x821x1941	38
V4152	Access Platform Ladder - 5 Step	1320	3.3	1489x862x2205	41
V4153	Access Platform Ladder - 6 Step	1584	3.6	1655x905x2469	44
V4154	Access Platform Ladder - 7 Step	1848	3.9	1826x747x2773	47
V4155	Access Platform Ladder - 8 Step	2112	4.1	1993x989x2997	51





## 6 Tonne Capacity 1 Piece Container Ramp

This container ramp is a great general purpose ramp for unloading containers using pallet trucks or forklifts. This is a one piece unit with forklift slots at the front for easy transport. Finished in painted yellow and supplied with chain & D Shackle, the 6 Tonne container ramp is ready for immediate delivery.

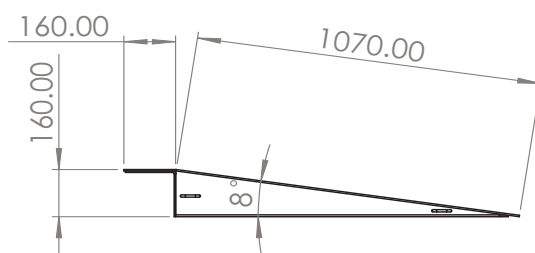
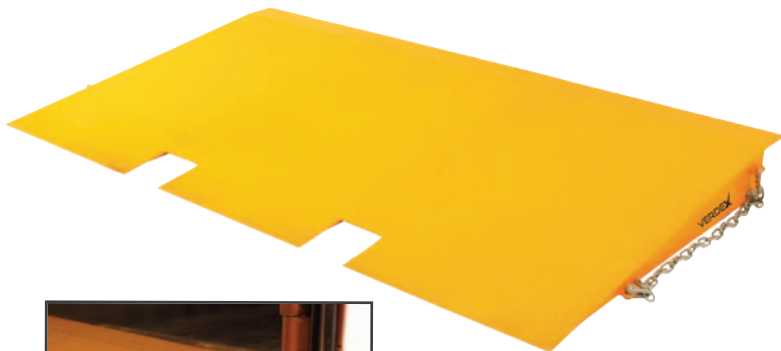

Code	Load Capacity (kg)	Width (mm)	Height (mm)	Length (mm)	Unit Weight (kg)
V4010	6000	2200	160	1200	180

## 8 Tonne Capacity 1 Piece Container Ramp

This container ramp is a great general purpose ramp for unloading containers using pallet trucks or forklifts. This is a one piece unit with forklift slots at the front and side for easy transport. Finished in painted yellow and supplied with chain & D Shackle, the 8 Tonne container ramp is ready for immediate delivery.

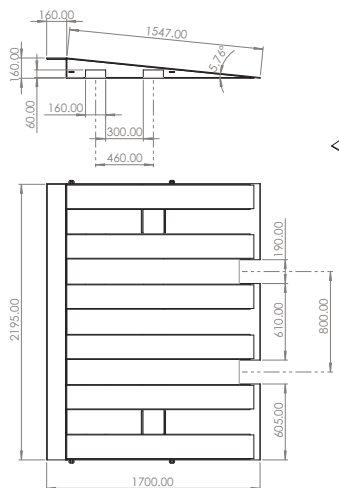

Code	Load Capacity (kg)	Width (mm)	Height (mm)	Length (mm)	Side Fork Pocket Size (mm)	Unit Weight (kg)
V4015	8000	2200	160	1720	80x165	270





# 7 Tonne Capacity Container Ramp

This container ramp is designed primarily for bridging into a standard container from ground level that is slightly uneven due to its self-levelling lip. The ramp footing fold has handles which you can easily fold back to move the ramp using the fork slots. Finished in painted yellow and supplied with chain & D shackle, the 7 Tonne container ramp is ready for immediate delivery.

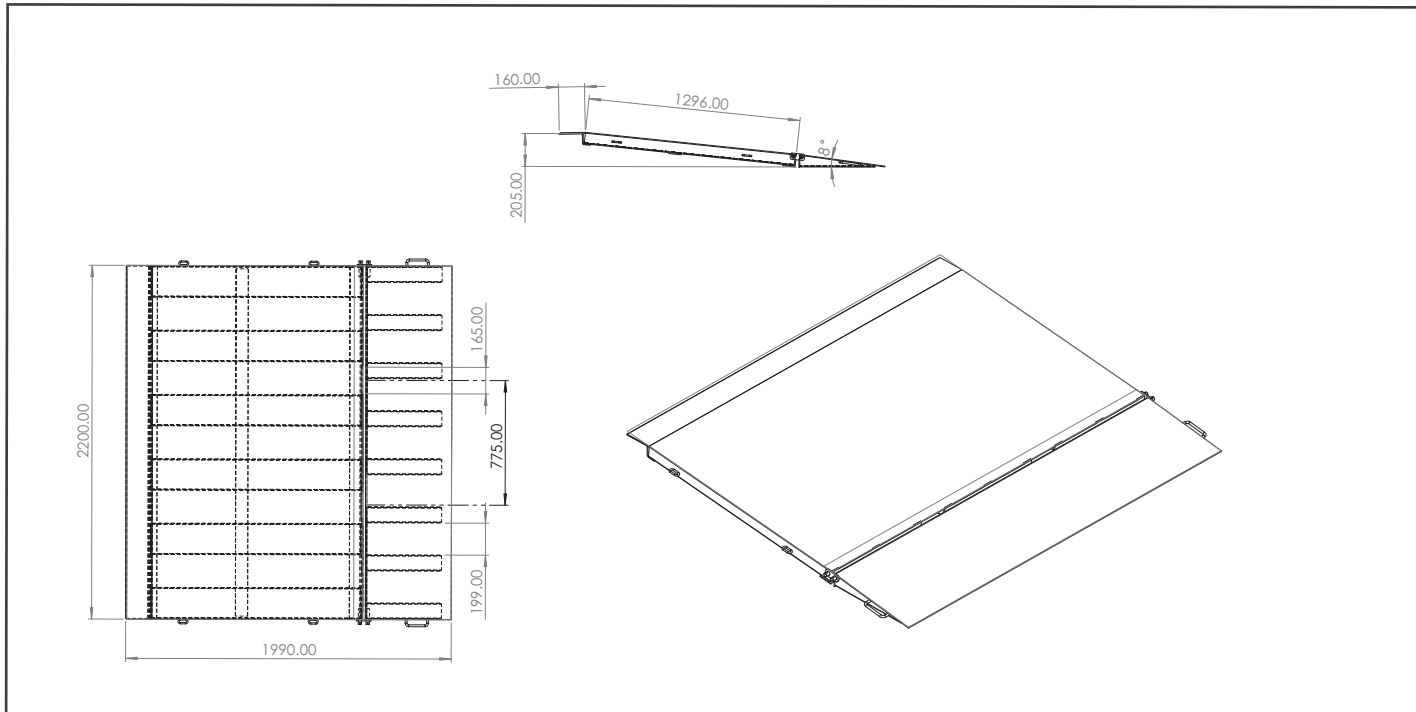

Watch a video of this in operation on our website here: [www.verdex.com.au/V4020](http://www.verdex.com.au/V4020)



Code	Load Capacity (kg)	Width (mm)	Length (mm)	Fork Pocket Centres (mm)	Fork Pocket Size (mm)	Unit Weight (kg)
V4020	7000	2200	2000	775	165x60	275



## 10 Tonne Heavy Duty Container Ramp

The V4025 container ramp is a heavy duty ramp for unloading containers of heavy products with a large forklift. This ramp has been designed for fast positioning and removal with tine pockets on the side plus pop up tine slots in the top for front removal. The ramp has an enamel painted finish. Comes standard with 100mm raised side plates which ensure the forklift remains on the ramp.

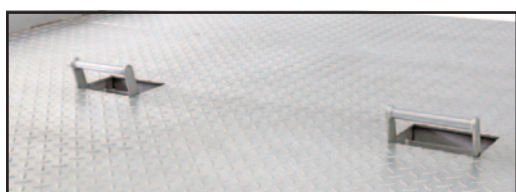
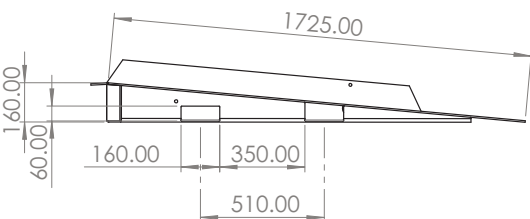

Pop-up fork slots which make it easy to move around with a forklift

Code	Load Capacity (kg)	Width (mm)	Length (mm)	Fork Pocket Size (mm)	Fork Pocket Centres (mm)	Unit Weight (kg)
V4025	10,000	2320	1800	160x60	510	410

## 10 Tonne Heavy Duty Container Ramp (Extra Long)

The V4030 extra long container ramp has an overall length of 3 metres. This ramp has been designed for fast positioning and removal with tine pockets on the side plus pop up tine slots in the top for front removal. The ramp has an enamel painted finish. Comes standard with 100mm raised side plates which ensure the forklift remains on the ramp.

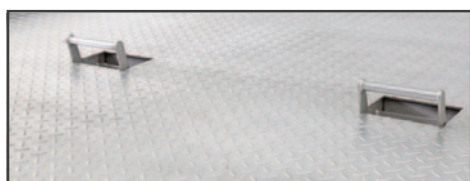
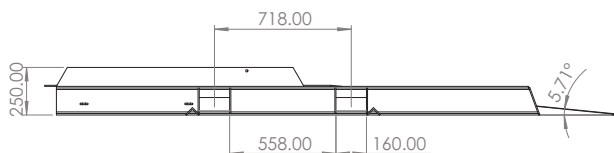

Pop-up fork slots which make it easy to move around with a forklift

Code	Load Capacity (kg)	Width (mm)	Overall Height (mm)	Length (mm)	Top Fork Pocket Centres (mm)	Unit Weight (kg)
V4030	10,000	2320	250	3000	718	600





# Mobile Loading Dock/Container Ramp

- Features a large deck for entry between truck and trailer
- Quick setup to minimise wasted time
- Designed specifically for rough applications
- Maintenance-free design eliminates downtime
- Towing / Maneuvering; the ramp has fork pockets at the lower end for a forklift to enter and push into position
- Safety chain for the securing ramp to the trailer
- Galvanized reinforced metal grate, making it ideal in slippery weather conditions
- Constructed from strong materials allowing it to be used frequently
- Two solid filled tires fitted to assist with ramp relocation
- Front Lip Length: 700mm
- Rear Lip Width: 2000mm
- Front Lip Width: 950mm
- Min / Max Height: 1060/1650mm



Watch a video of this in operation on our website here: [www.verdex.com.au/v4040](http://www.verdex.com.au/v4040)



Code	Load Capacity (kg)	Ramp Length (mm)	Ramp Width (mm)	Ascent Length (mm)	Straight Length (mm)	Unit Weight (kg)
V4040	8000	10500	2150	5000	2500	2650



## Galvanised Concrete Collection Tray

- The Galvanised Concrete Collection Tray is designed to limit environmental damage wherever a concrete pump is being used on site.
- This low profile tray fits under the concrete pump to collect spillage washout water and concrete waste.
- Fitted with 4-way fork pockets and four crane lifting and up-ending lugs and is manufactured with tapered sides.
- Capacity: 0.85 cu. m
- Galvanised Finish



Code	SWL (kg)	Overall Size LxWxH (mm)	Fork Pocket Size (mm)	Fork Pocket Centres (mm)	Unit Weight (kg)
V6211	1500	2070x1765x400	160x75/160x95	870	215

## Concrete Collection Tray

- The Concrete Collection Trays are designed to limit environmental damage wherever a concrete pump is being used on site.
- This low profile tray fits under the concrete pump to collect spillage washout water and concrete waste.
- Low profile tray with tapered sides
- Reinforced base and sides
- Fitted with crane lifting and up-ending lugs
- 4-way fork pockets allowing access from all sides
- Optional disposable plastic liner available
- Enamel paint finish
- Fork Pocket Centres: 880mm



V6210



V6212

Code	Details	SWL (kg)	Overall Size LxWxH (mm)	Fork Pocket Size (mm)	Unit Weight (kg)
V6210	Concrete Collection Tray (0.5 cubic metres)	1000	1860x1560x360	170x85	150
V6212	Disposable Plastic Liner to suit V6210				



# Concrete Block Moulds

- The Concrete Moulds' simple construction and portable design make it the perfect solution for recycling leftover concrete on-site.
- Simple construction is fast to assemble
- Lightweight & stackable design is easy to transfer between sites
- Concrete blocks can be used as temporary foundation blocks, retaining walls, security blocks and anchor blocks for boat moorings
- Provision for cast in ferrule (suits 12mm reinforcing bar)
- Supplied with a single M20 eyebolt and ferrule
- Half mould insert available for smaller blocks to be used in retaining wall applications
- Enamel paint finish
- Finished Block Dimensions: 1200x600x600mm



Watch a video of this in operation on our website here: [www.verdex.com.au/V6200](http://www.verdex.com.au/V6200)



V6200



V6201 - Half Mould Insert



V6206 - M20 Eyebolt

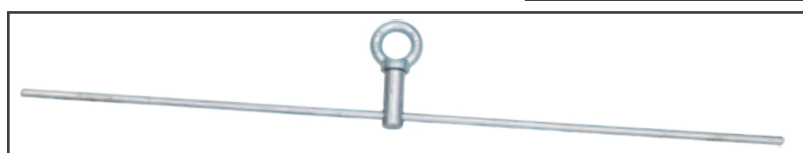

V6205 - Ferrule Kit



Code	Description	Finished Block Dimensions (mm)	Overall Dimensions (mm)	Unit Weight (kg)
V6200	Concrete Block Mould (0.432cu.m capacity)	1200x600x600	1356x756x600	178
V6201	Half Mould Insert to suit V6200			
V6205	Ferrule Kit - Includes Ferrule & 1m Reo Bar & M20 Eyebolt			
V6206	M20 Eyebolt			





## Concrete Kibble

The unit is lever operated from either side for easy flexible operation and heightened user control. Easily transport around a working environment or job site with it's included forklift pockets. This accessory helps facilitate safe and manageable pouring of concrete with an enamel painted finish in blue.

- Painted blue enamel
- Safe Working Load (SWL) 3000kg
- Volume Capacity 1.0 cubic metres



V6230



Concrete Funnel attached to V6226

Code	Description	Overall Dimensions LxWxH (mm)	Fork Pocket Size (mm)	Fork Pocket Centres (mm)	Unit Weight (kg)
V6226	Concrete Kibble (1 CBM)	1760x1655x1705	165x65	870	320
V6230	Concrete Funnel to suit Kibble				





## Bulk Bag Filling Frame

This frame is designed to safely hook open a bulk bag and fill with free-flowing bulk products such as sand and gravel, removing the need for the operator to hold the bag open or manually fill themselves.

- 4 safety swivel hooks hold bulk bag in position whilst filling
- Adjustable bag restraining chains position bulk bag at correct height
- 3 adjustable height settings to suit your operational requirements
- Fork pockets fitted for easy transport
- Optional clamshell gate for control over flow rate
- Optional spill guard prevents overspill
- Upper hopper assembly enamel paint finish.  
Support frame zinc finish
- Fork Pocket Size: 140x65mm
- Fork Pocket Centres: 850mm



Code	Description	Overall Dimensions (mm)	Hopper Opening (mm)	Unit Weight (kg)
V6220	Bulk Bag Filling Frame	1800x1150	554x400	270
V6221	Optional Clamshell Gate			
V6222	Optional Spill Guard			

## A-Frame Rigging Racks

The A-Frame Rigging Storage Rack is the ideal solution to manage and store rigging equipment such as chains, slings, shackles, hooks and clamps when not in use.

- Hanging hooks store and organise your rigging equipment
- Solid base keeps your rigging equipment off the floor
- Strong 'A' frame construction provides stability
- Fork pockets and crane lugs fitted for transport by forklift or crane
- Wheels fitted (removable) for complete manoeuvrability
- Suits storage of rigging equipment at industrial facilities
- Storage trays are available as an optional extra
- Supplied flatpack for transport
- Enamel paint finish with zinc finish lid



V7577 - Optional Storage Tray



V7575



V7576

Code	Details	Overall Dimensions LxWxH (mm)	Fork Pocket Size (mm)	Fork Pocket Centres (mm)	Unit Weight (kg)
V7575	A-Frame Rigging Rack - 1250mm	1250x1150x2045	140x90	450	110
V7576	A-Frame Rigging Rack - 2000mm	2000x1150x2045	140x90	750	130
V7577	Rigging Storage Rack Tray	570x1150x150	-	-	18



## Boot Cleaning Brush & Grate

- Designed to accommodate cleaning one shoe at a time
- Metal grate for scraping off hard stuck on debris
- Reduces cleaning costs by stopping dirt from being walked inside
- Heavy duty metal construction is built tough to last
- Suits mining, construction, recycling, agriculture or any industry where dirt is a problem
- 3 brushes with coarse bristles
- Comes standard with 4 x M12 mounting holes
- Hot Dipped Galvanised



Code	Overall Dimensions WxDxH (mm)	Unit Weight (kg)
V6420	600x490x1000	19

## Rigging Hanging Rack

The Rigging Hanging Rack is the ideal solution to manage and store rigging equipment such as chains, slings, shackles, hooks and clamps when not in use.

- Heavy duty construction hook plate
- 5 hooks to store and organise your rigging equipment
- 16mm diameter hooks for optimal strength and capacity
- 4 x 8mm drill holes for securely mounting to a wall
- Suits storage of rigging equipment at industrial facilities
- Enamel paint finish



Code	Hook Diameter (mm)	Hook Centres (mm)	Overall Dimensions WxDxH (mm)	Unit Weight (kg)
V7603	16mm	150	930x100x220	5





## Site Tool Cabinets

- These Site Tool Cabinets are designed as a secure storage solution on work sites that can be transported by overhead crane and forklift.
- Heavy duty construction
- Fitted with crane lugs and fork pockets for easy relocation
- Adjustable shelves allowing flexible storage options
- Dual locking mechanism door provide added security against theft
- Designed & certified in accordance with Australian Standards
- Wheels fitted (removable)
- Powder coated finish
- Features a dust and weatherproof seal
- Working Load Limit (WLL): 1000kg
- Load Centre: 350mm
- HCG: 376mm



V7570



V7571



Adjustable Shelves



Weather proof seal

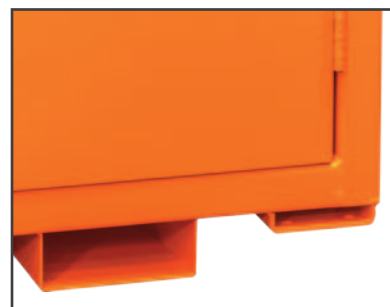

Fork Pockets

Code	Details	Opening WxH (mm)	Overall Dimensions WxDxH (mm)	Fork Pocket Size (mm)	Fork Pocket Centres (mm)	Unit Weight (kg)
V7570	Site Tool Cabinet - Single Door	1055x1055	1155x700x1450	166x67	660	180
V7571	Site Tool Cabinet - Double Door	1250x1405	1350x800x1815	166x67	762	260



# Site Tool Box

The Single Site Tool Box is designed as a secure storage solution on work sites that can be transported by overhead crane and forklift.

- Heavy duty, weather proof construction
- Fitted with crane lugs and fork pockets for easy relocation
- Tamper proof, lockable door provides security against theft
- Gas strut fitted for easy opening
- Wheels fitted (removable)
- Fully engineered in Australia in accordance with Australian Standards
- Enamel paint finish



Crane Lifting Lugs



Fork Pockets



Weather proof seal



Code	Working Load Limit (kg)	Opening WxH (mm)	Inside Clearance WxDxH (mm)	Fork Pocket Size (mm)	Fork Pocket Centres (mm)	Unit Weight (kg)
V7572	1000	1055x1055	955x555x600	155x55	646	110



## Expanding Skate Conveyors

- Self tracking flexible expanding conveyor which expands from 1100mm to 4000mm
- Multiple units can be joined to make 1 continuous conveyor system
- Excellent for truck and container unloading and for assembly lines
- Easy and quick setup with adjustable height legs and brake castors on every leg
- Reduces manual handling
- Bolted steel construction with skate wheels



Watch a video of this in operation on our website here: [www.verdex.com.au/V3005](http://www.verdex.com.au/V3005)



Code	Width (mm)	Load Capacity Per Metre (kg)	Castors (mm)	Length Retracted (mm)	Length Expanded (mm)	Height Range (mm)	Unit Weight (kg)
V3005	460	100	125	1100	4000	690-1000	112
V3006	610	100	125	1100	4000	690-1000	124
V3007	760	100	125	1100	4000	690-1000	142

## Expanding Roller Conveyors

- The flexible expanding roller conveyor expands from 1500mm to 4000mm
- Multiple units can be joined to make 1 continuous conveyor system
- The roller conveyor is good for odd shaped cartons and bags of goods where the skate wheel conveyor wont work
- Easy and quick setup with height adjustable legs and brake castors on every leg
- Reduces manual handling
- Bolted steel construction with steel rollers
- 85mm gap between rollers

*Stainless Steel options available online*



Watch a video of this in operation on our website here: [www.verdex.com.au/V3010](http://www.verdex.com.au/V3010)



Code	Width (mm)	Load Capacity Per Metre (kg)	Castors (mm)	Length Expanded (mm)	Length Retracted (mm)	Height Range (mm)	Unit Weight (kg)
V3010	460	130	125	4000	1500	690-1000	96
V3011	610	130	125	4000	1500	690-1000	116
V3012	760	130	125	4000	1500	690-1000	126





## Expanding Nylon Skate Conveyor

- Self tracking flexible conveyor which can expand from 1100mm to 4000mm
- Multiple units can be joined to make 1 continuous conveyor system
- Excellent for truck and container unloading and for assembly lines
- Easy and quick setup with adjustable height legs and brake castors on every leg
- Reduces manual handling
- Bolted steel construction with nylon skate wheels



Nylon Skate Wheel

Code	Width (mm)	Load Capacity Per Metre (kg)	Castors (mm)	Length Retracted (mm)	Length Expanded (mm)	Height Range (mm)	Unit Weight (kg)
V3041	610	75	105	1100	4000	690-1000	90

## Electric Expanding Roller Conveyors

- Simply plug in and go, this powered electric roller conveyor is great for carrying boxes and items up hill where gravity may not be achievable
- This conveyor is flexible and expands from 1500mm to 4000mm
- Multiple units can be joined to make 1 continuous powered conveyor system
- Great for loading and unloading containers
- Easy and quick setup with adjustable height legs and brake castors on every leg
- Quiet operation 240V AC motor with forward and reverse action and adjustable roller speed



Code	Width (mm)	Load Capacity Per Metre (kg)	Castors (mm)	Length Retracted (mm)	Length Expanded (mm)	Height Range (mm)	Unit Weight (kg)
V3030	460	140	125	1500	4000	690-1000	126
V3031	610	140	125	1500	4000	690-1000	131
V3032	760	140	125	1500	4000	690-1000	172



## Conveyor Components

Roller conveyors are one of the most common types of conveyors applied in conveying flat bottom type products. These kind of conveyors improve efficiency distribution & line links between different stages of production of your product.

### V3240

- Power coated Blue
- 40 Rollers = 75mm pitch between roller
- 20 Rollers = 150mm pitch between roller
- Frame Capacity: 200kgs / mtr

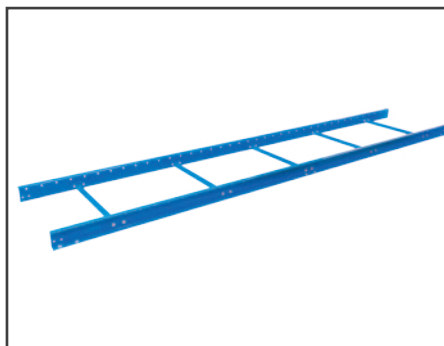

V3240 - Conveyor Frame

### V3140

- Power coated Blue
- Adjustable Height: 805-1105mm (includes frame)



V3140 - Conveyor Stand

### V3142

- Roller Size: 527x48mm
- Shaft Size: 10x8mm
- Spring Loaded Shaft
- Pre-Galvanized Tube 1.65mm Thick
- Capacity: 100kg / Roller
- 20 per carton



V3142 - 600mm Steel Rollers

### V3143

- Roller Size: 527x48mm
- Shaft Size: 10x8mm
- Spring Loaded Shaft
- Capacity: 20kg / Roller
- 20 per carton



V3143 - 600mm Poly Rollers



V3144 - 600mm Conveyor Gate



V3102 - Castor Kit to suit V3144



V3145 - Conveyor End Stop

Code	Description	Overall Size LxWxH (mm)	Unit Weight (kg)
V3240	Conveyor Frame - 600x3000mm (Rollers Sold Separately)	3000x660x80	19
V3140	Conveyor Stand to suit 600mm Frames	660x125x1015	8.5
V3142	600mm Galvanised Steel Rollers (20 Rollers per carton)	552x48	1.35
V3143	600mm Poly Rollers (20 Rollers per carton)	552x48	0.98
V3144	600mm Conveyor Gate (Steel Rollers only)	2025x660x1105	88
V3102	Castor Kit to suit V3144		2
V3145	Conveyor End Stop to suit V3144		



## Steel Roller Conveyor Kit (3 Metres long x 600mm wide)

Roller conveyors are one of the most common types of conveyors applied in conveying flat bottom type products such as cases, boxes, pallets & trays. These kind of conveyors improve efficiency distribution & line links between different stages of production of your product.

- Powdercoated Blue Frames and Legs
- Supplied with 40pcs Galvanised Steel Rollers
- Supplied with 3 Stands
- Can be joined together to make one continuous conveyor line
- Pitch: 75mm



V3145

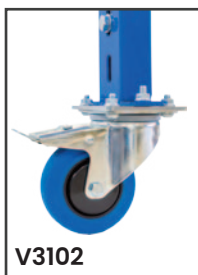

V3102

Code	Details	Capacity (kg/M)	Adjustable Height (mm)	Overall Size LxWxH (mm)	Unit Weight (kg)
V3340	Steel Roller Conveyor Kit	200	805-1105	3000x660x1105	98
V3102	Castor Kit to suit V3340				
V3145	Conveyor End Stop to suit V3340				

## Poly Roller Conveyor Kit (3 Metres long x 600mm wide)

Roller conveyors are one of the most common types of conveyors applied in conveying flat bottom type products such as cases, boxes, pallets & trays. These kind of conveyors improve efficiency distribution & line links between different stages of production of your product.

- Can be joined together to make one conveyor line
- Supplied With 40pcs Poly Rollers
- Supplied With 3 Stands
- Pitch: 75mm
- Powdercoated Blue Frames and Legs



V3145



V3102

Code	Details	Capacity (kg/M)	Adjustable Height (mm)	Overall Size LxWxH (mm)	Unit Weight (kg)
V3341	Steel Roller Conveyor Kit	120	805-1105	3000x660x1105	88
V3102	Castor Kit to suit V3341				2
V3145	Conveyor End Stop to suit V3341				

